

Constant-/variable flow damper DAVU



Description

Constant flow damper with electric motor for continuous setting of one flow

DAVU is a constant flow damper, which facilitates balancing of ventilation systems and gives correct flow from the start.

The unit compensates for e.g. connection and disconnection of system parts, clogging of filters and ducts, thermal lift forces, wind effects, window opening etc.

The motor shall be completed with control signal transmitter e.g. an external potentiometer or a proportionally regulating thermostat. A special mounting, measuring, balancing and maintenance instruction exists for this product.

Ø 80–315 fullfills pressure class A in closed position. Fulfills tightness class C.

Dimensions

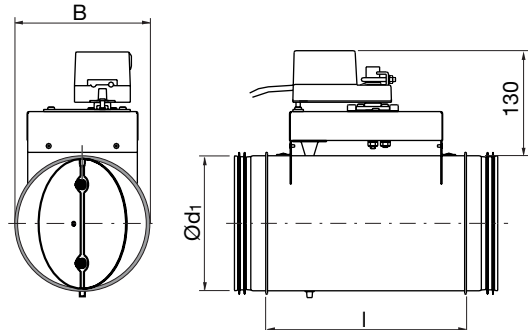

Ød ₁ nom	l mm	B mm	m kg	Tightness class across closed blade
80	246	122	1,95	0
100	246	122	2,00	0
125	246	135	2,25	0
160	246	170	2,45	0
200	246	210	2,86	0
250	284	260	3,95	0
315	334	325	5,35	0

Order code

Product	DAVU	125	24	LMSX
Type				
Dimension Ød ₁				
Voltage				
Motor type				

Technical data for the motor

Power supply.....	LM 24 A-SX AC 19,2–28,8 V, 50/60 Hz DC 21,6–28,8 V
Power consumption.....	2 W
For wire sizing.....	4 VA
Connection.....	Cable 1 m, 4x0,75 mm ²
Operating angle.....	Max. 95°, adjustable 0–100 %
Torque at nominal voltage.....	Min. 5 Nm
Direction of rotation.....	Switch selectable 0/1
Position at Y=0 V.....	Switch selectable 0 or 1
Position indication.....	Mechanical
Running time for 90°.....	150 s
Sound power level.....	35 dB (A)
Protection class.....	III Safety extra-low voltage
Protection type.....	IP 54
Ambient temperature range.....	-30 to +50 °C
Ambient humidity.....	95 % RH

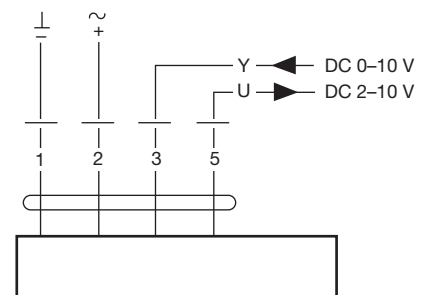

Constant-/variable flow dampers

DAU, DA2EU, DAVU

Summary

- DAU - manual single flow unit
- DA2EU - motorized twin flow unit
- DAVU - motorized variable flow unit
- Diameters Ø 80–315
- Flow range 15–830 l/s (54–2988 m³/h)
- Pressure range 50–1000 Pa (over the unit)
- Independent of mounting direction
- Handles 50 mm duct insulation

Function

The constant flow damper is an automatic damper, which at varying pressures wholly mechanical and independent of external energy sources maintains a set flow constant. The force, needed for regulation, is taken from the passing air stream. The air stream across the blade attempts to close it and generates a closing torque. This is balanced by an opposed opening force from a spring. The greater the pressure across the blade the more it closes. A bellows eliminates oscillations, which could occur at unfavourable conditions of operation.

Types

The following types exist:

- DAU – one flow unit – with knob and arrow for manual setting of one flow.
- DA2EU – two flows unit – with electric motor for switching between two flows.
- DAVU – variable flow unit – with electric motor for continuous setting of one flow.

Material

Housing and damper blade are of galvanized sheet metal and shaft is of stainless steel.

Temperature

Working range: +5 to +70 °C.

Insulation

The units can handle 50 mm duct insulation without the scale or the motor being hidden.

DAU is available with an 45 mm external insulation and an outer sheet metal shell for lower sound radiation to the surroundings. Is then called DALU.

Regulating accuracy

The units are calibrated from factory within their whole working range. In this the units keep the flow constant within approximately ±5 to ±10% of the set flow. Greater deviations occur at the lower flows, especially for small sizes.

Flow setting

The units can not be delivered from factory with a preset flow. You can set the flow yourself very easy following to the instruction for each product.

Disturbance tolerance

In order to achieve the stated accuracy for the pre-set flow a straight distance of at least 3×d before and at least 1,5×d after the units are required. A mounting close to a source of disturbance (bend, saddle etc.) decreases the regulation accuracy and the flow may deviate from the set value.

Change of direction

The units are independent of their mounting direction and one may deviate from the specified direction and mount them in any direction without affecting the accuracy.

Combinations

The units can be mounted together with e.g. a motorized shut off damper DTBU, see page side 276. Constant flow damper combined with shut off damper can with advantage be used in groups at installations where you want:

- two flows, that lies too far away from each other for a two flow unit to handle

or

- more than two flows

Presume:	Basic flow	= 80 l/s
	Forced flow 1	= 100 l/s
	Forced flow 2	= 150 l/s

Four flows will then be possible:

80, 180, 230 and 330 l/s.

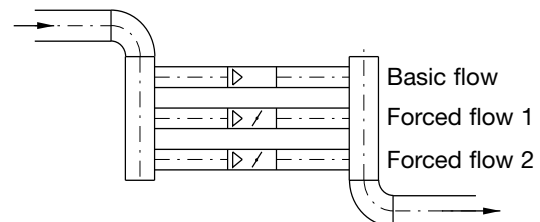

Technical data

DAU, DA2EU, DAVU

Technical data

Pressure and flow ranges and sound to duct

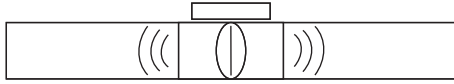

The graphs show A-weighted sound power level, L_{WA} [dB], to duct. These curves are intended for brief comparison. For more accurate calculation, please use the tables.

Example

Given: Diameter 125 mm
Flow 70 l/s
Pressure drop 200 Pa

The graph gives:

A-weighted sound power level approx. 57 dB

The table gives:

Sound power level as below

Centre frequency [Hz]	63	125	250	500	1 k	2 k	4 k	8 k
Sound power level [dB]	52	52	49	49	49	51	51	46

Explanation to Diagrams

v : Air velocity
 dp_t : pressure loss
 q : Volumeflow

Ø 80

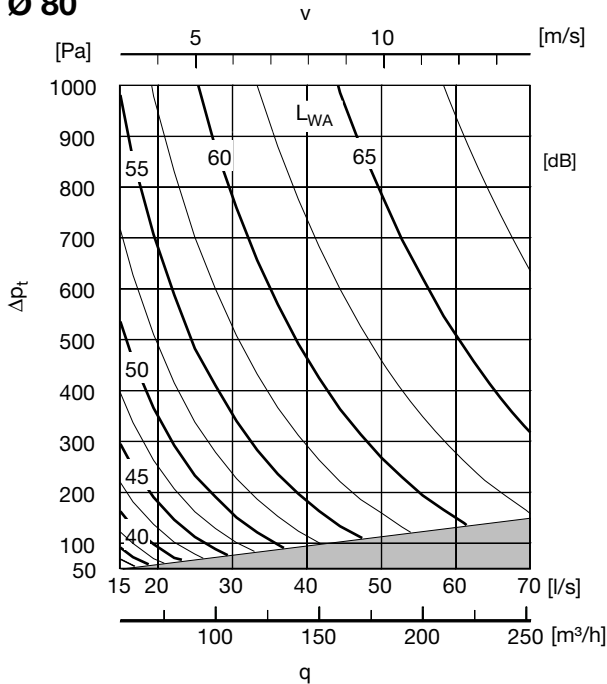

Ø 100

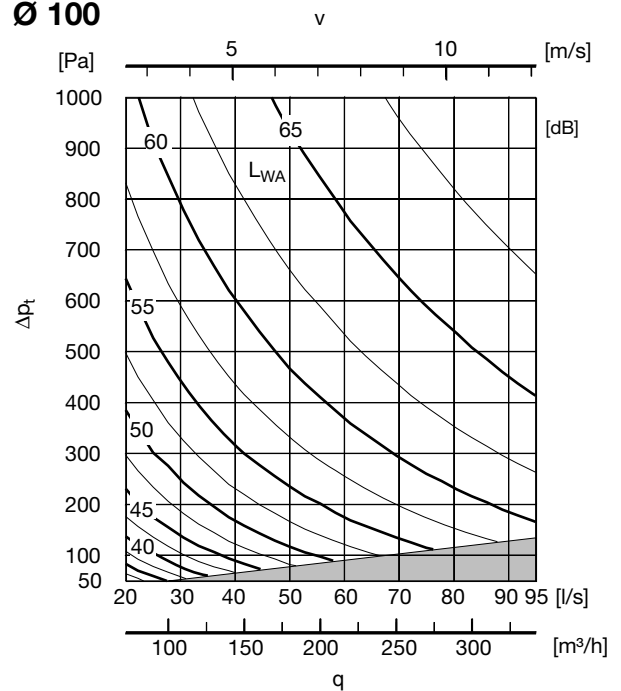

Ø 125

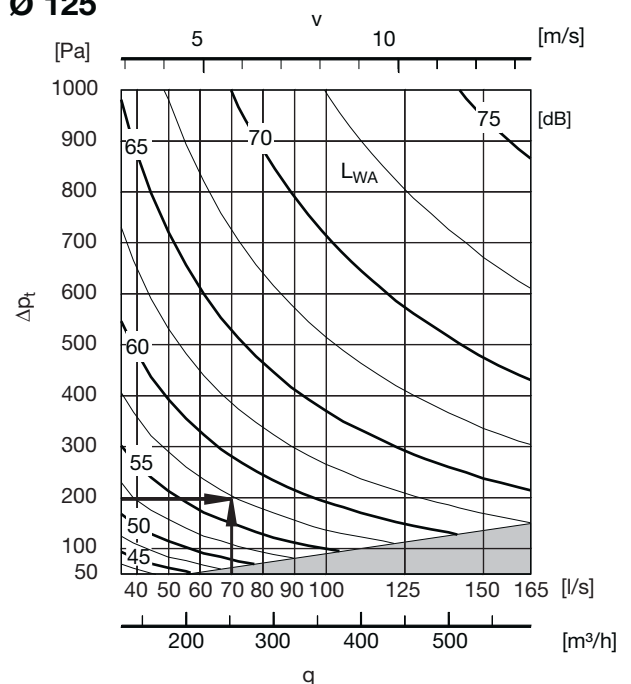

Technical data

DAU, DA2EU, DAVU

Technical data

Pressure and flow ranges and sound to duct

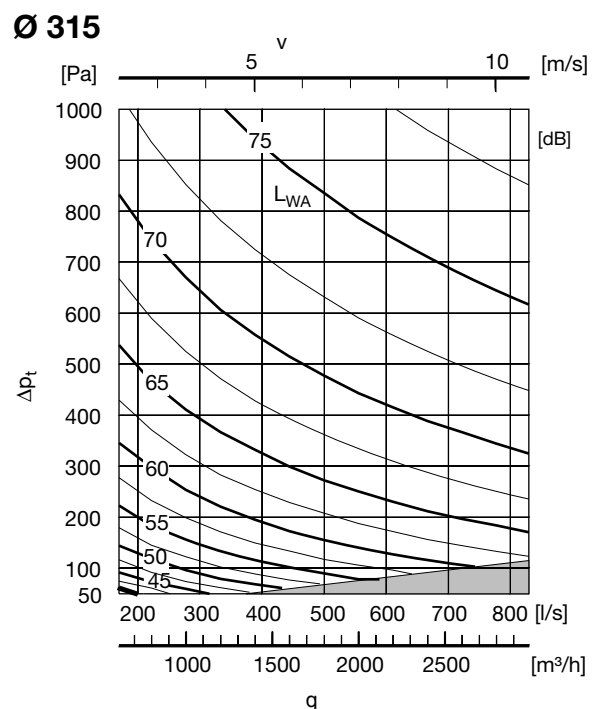
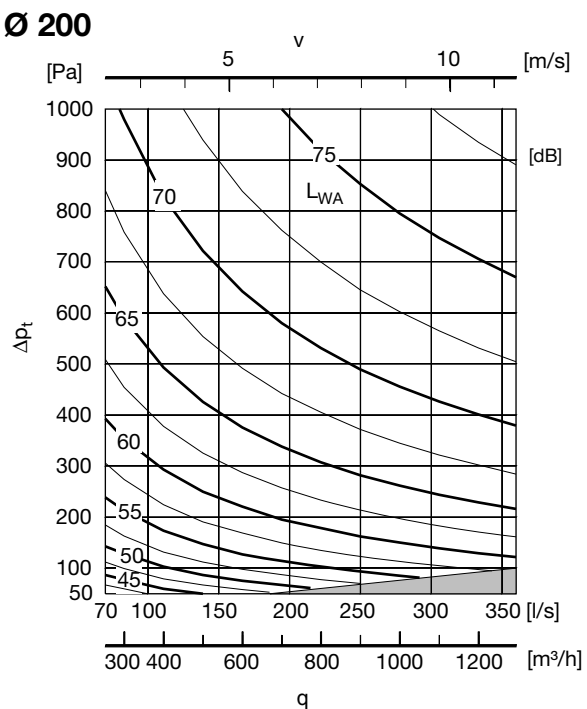
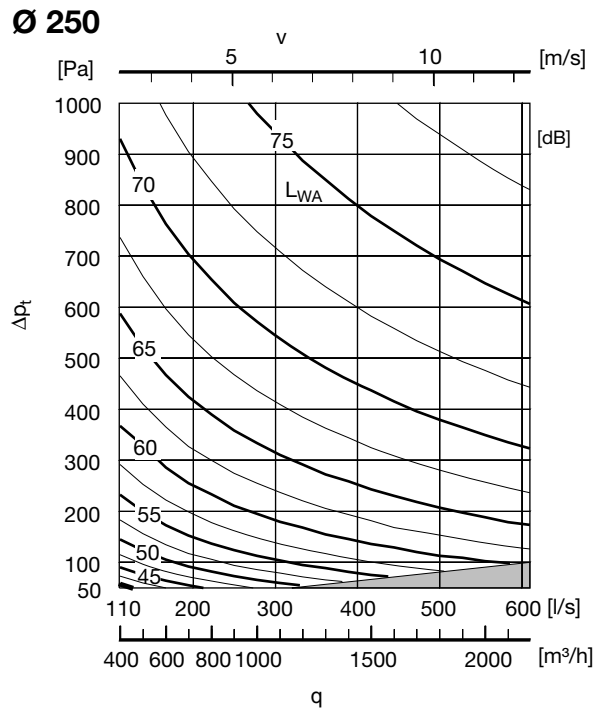
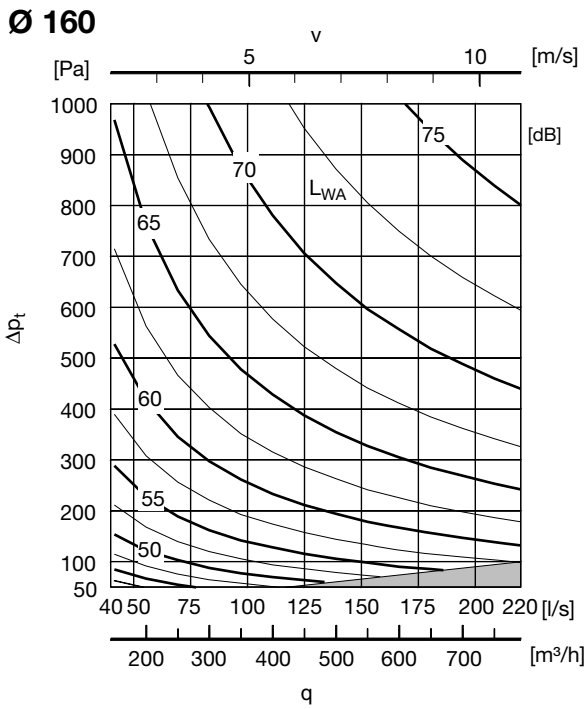

- 1
- 2
- 3
- 4
- 5
- 6
- 7
- 8
- 9
- 10
- 11
- 12
- 13
- 14
- 15
- 16
- 17
- 18

Technical data

DAU, DA2EU, DAVU

Technical data

Sound to duct

Sound power level, L_w [dB], to duct in octave bands 1–8, 63–8000 Hz, as function of diameter, pressure drop and flow.

Ød ₁	Pressure drop [Pa]	Velocity app. 2,5 [m/s]								Velocity app. 6 [m/s]							
		Centre frequency [Hz]								Centre frequency [Hz]							
		63	125	250	500	1k	2k	4k	8k	63	125	250	500	1k	2k	4k	8k
		Flow 15 [l/s]								Flow 30 [l/s]							
80	1000	51	49	44	44	46	49	49	44	56	56	53	53	53	55	55	50
	500	45	43	38	38	40	43	43	38	51	51	49	49	49	51	50	46
	200	37	35	30	30	32	35	35	30	45	45	43	43	43	45	44	40
	100	32	30	25	25	27	30	30	25	41	41	39	39	39	41	40	35
	50	26	24	19	19	21	24	24	19	–	–	–	–	–	–	–	–
		Flow 20 [l/s]								Flow 45 [l/s]							
100	1000	56	53	48	48	50	53	54	48	59	59	57	57	57	59	58	53
	500	49	46	41	41	43	47	47	42	54	54	51	51	51	53	53	48
	200	39	37	31	31	33	37	37	32	47	47	44	44	45	47	46	41
	100	34	31	26	26	28	32	32	27	42	42	39	39	40	42	41	36
	50	26	24	18	18	20	24	24	19	–	–	–	–	–	–	–	–
		Flow 30 [l/s]								Flow 70 [l/s]							
125	1000	60	58	52	52	54	58	58	53	64	64	62	62	62	64	63	59
	500	54	52	46	46	48	52	52	47	59	59	56	57	57	59	58	53
	200	46	44	38	38	40	44	44	39	52	52	49	49	49	51	51	46
	100	40	38	32	32	34	38	38	33	46	46	44	44	44	46	45	40
	50	34	32	26	26	28	32	32	27	–	–	–	–	–	–	–	–
		Flow 40 [l/s]								Flow 120 [l/s]							
160	1000	62	59	52	52	55	59	60	54	67	67	65	65	65	67	66	61
	500	56	53	47	47	49	53	54	48	61	61	59	59	59	61	60	55
	200	49	46	39	39	42	46	47	41	53	53	51	51	51	53	52	47
	100	43	40	33	33	36	40	41	35	48	48	46	46	46	48	47	42
	50	37	34	27	27	30	34	35	29	–	–	–	–	–	–	–	–
		Flow 70 [l/s]								Flow 180 [l/s]							
200	1000	66	63	57	57	59	63	63	58	69	69	66	66	66	68	68	63
	500	59	56	50	50	53	57	57	52	62	62	60	60	60	62	61	57
	200	50	47	41	41	43	47	47	42	54	54	51	51	52	54	53	48
	100	43	40	34	34	36	40	40	35	47	47	45	45	45	47	46	42
	50	37	34	28	28	30	34	34	29	–	–	–	–	–	–	–	–
		Flow 110 [l/s]								Flow 300 [l/s]							
250	1000	67	64	59	59	61	65	65	60	70	70	67	68	67	69	69	64
	500	60	57	51	51	53	57	57	52	63	63	61	61	61	63	62	57
	200	50	47	41	41	43	47	47	42	55	55	53	53	53	54	54	49
	100	43	40	34	34	36	40	40	35	49	49	47	47	47	48	48	43
	50	35	32	26	26	28	32	33	27	43	43	40	41	40	42	42	37
		Flow 170 [l/s]								Flow 470 [l/s]							
315	1000	69	66	60	60	62	66	67	61	70	70	68	68	68	70	69	65
	500	61	58	52	52	54	58	59	53	64	64	62	62	62	64	63	59
	200	50	47	41	41	44	48	48	43	56	56	54	54	54	56	55	50
	100	42	40	34	34	36	40	40	35	50	50	47	47	47	49	49	44
	50	35	32	26	26	29	33	33	28	–	–	–	–	–	–	–	–

Technical data

DAU, DA2EU, DAVU

Technical data

Sound to duct

Sound power level, L_W [dB], to duct in octave bands 1–8, 63–8000 Hz, as function of diameter, pressure drop and flow.

Ød ₁	Pressure drop [Pa]	Velocity app. 9 [m/s]								Velocity app. 12 [m/s]							
		Centre frequency [Hz]								Centre frequency [Hz]							
		63	125	250	500	1k	2k	4k	8k	63	125	250	500	1k	2k	4k	8k
		Flow 45 [l/s]								Flow 70 [l/s]							
80	1000	58	59	59	59	58	59	58	53	61	64	65	65	63	63	61	57
	500	55	56	55	55	54	55	54	50	59	61	62	62	60	60	59	55
	200	50	51	51	51	50	51	50	45	55	58	59	59	57	57	55	51
	100	–	–	–	–	–	–	–	–	–	–	–	–	–	–	–	–
	50	–	–	–	–	–	–	–	–	–	–	–	–	–	–	–	–
		Flow 70 [l/s]								Flow 95 [l/s]							
100	1000	61	62	61	62	61	62	61	56	62	64	65	65	63	63	62	58
	500	56	58	57	57	56	57	56	51	59	60	61	61	59	60	58	54
	200	51	52	51	51	50	51	50	46	53	55	56	56	54	54	53	49
	100	47	48	47	47	46	47	46	42	–	–	–	–	–	–	–	–
	50	–	–	–	–	–	–	–	–	–	–	–	–	–	–	–	–
		Flow 110 [l/s]								Flow 165 [l/s]							
125	1000	66	67	67	67	66	67	66	61	68	71	71	72	70	70	68	64
	500	61	62	62	62	61	62	61	56	63	66	66	67	65	65	63	59
	200	54	55	55	55	54	55	54	49	57	59	60	60	58	58	57	52
	100	50	51	50	50	49	50	49	45	–	–	–	–	–	–	–	–
	50	–	–	–	–	–	–	–	–	–	–	–	–	–	–	–	–
		Flow 180 [l/s]								Flow 220 [l/s]							
160	1000	69	70	69	69	68	69	68	64	70	71	71	71	70	71	69	65
	500	63	64	63	63	62	63	62	58	64	66	66	66	64	65	64	59
	200	55	56	56	56	55	56	55	50	56	58	58	58	57	57	56	52
	100	50	51	50	50	49	50	49	45	51	52	52	52	51	52	50	46
	50	–	–	–	–	–	–	–	–	–	–	–	–	–	–	–	–
		Flow 280 [l/s]								Flow 360 [l/s]							
200	1000	70	71	71	71	70	71	70	65	71	73	73	73	72	72	71	67
	500	64	65	64	64	63	64	63	59	65	67	67	67	65	66	65	60
	200	56	57	56	56	55	56	55	51	57	58	59	59	57	58	56	52
	100	50	51	50	50	49	50	49	45	51	53	53	53	52	52	51	47
	50	–	–	–	–	–	–	–	–	–	–	–	–	–	–	–	–
		Flow 450 [l/s]								Flow 600 [l/s]							
250	1000	71	72	71	71	70	71	70	66	72	73	74	74	72	73	71	67
	500	65	66	65	65	64	65	64	60	66	68	69	69	67	67	66	62
	200	57	58	57	57	56	57	56	52	58	60	61	61	59	59	58	54
	100	51	52	52	52	51	52	51	46	54	55	56	56	54	55	53	49
	50	–	–	–	–	–	–	–	–	–	–	–	–	–	–	–	–
		Flow 700 [l/s]								Flow 830 [l/s]							
315	1000	71	72	72	72	71	72	71	66	72	73	73	73	72	73	71	67
	500	66	67	66	66	65	66	65	61	66	67	67	68	66	67	66	61
	200	58	59	59	59	58	59	58	53	59	60	60	60	59	60	58	54
	100	52	53	53	53	52	53	52	47	–	–	–	–	–	–	–	–
	50	–	–	–	–	–	–	–	–	–	–	–	–	–	–	–	–



Technical data

DAU, DA2EU, DAVU

Technical data

Pressure and flow ranges and sound to the surroundings

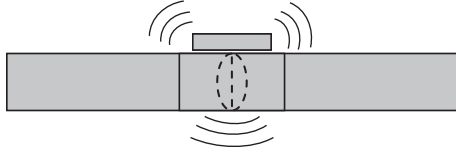

The graphs show A-weighted sound power level, L_{WA} [dB], to the surroundings.

Example:

Given:	Diameter	125 mm
	Flow	70 l/s
	Pressure drop	200 Pa

The graph gives:

A-weighted sound power level approx. 40 dB

The A-weighted sound pressure level in the middle of the room becomes approx. 8 dB lower than these graph values.

With insulation shell around the unit (the DALU unit) the A-weighted sound pressure level in the middle of the room becomes approx. 26 dB lower than the graph values on condition that also the connected ducts are attenuated (insulated) to the same extent.

Still lower sound pressure level can be achieved with additional constructional sound attenuation measures (false ceiling, high room attenuation).

Ø 100

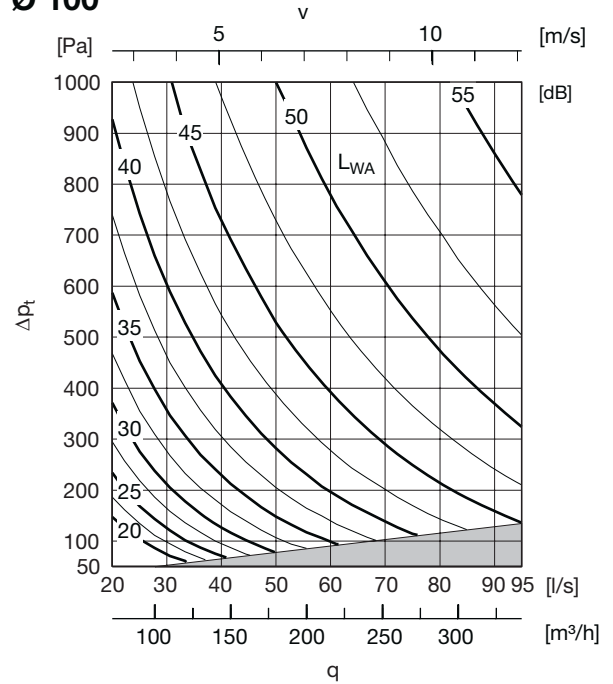

Ø 80

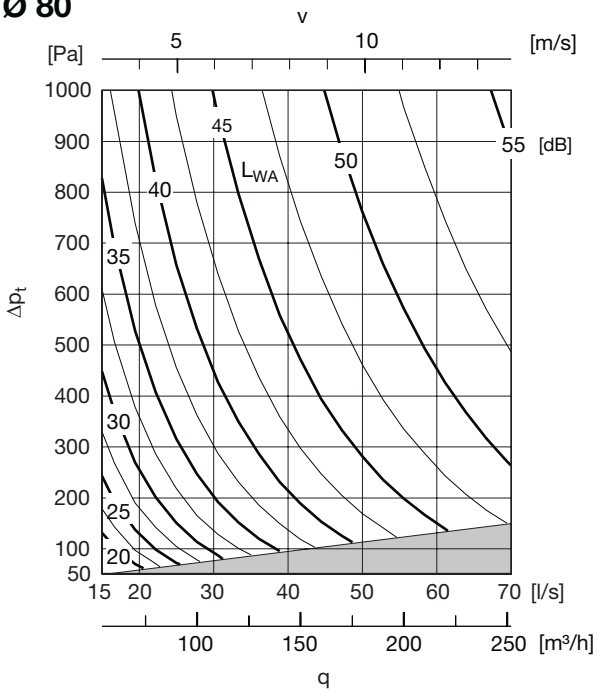

Ø 125

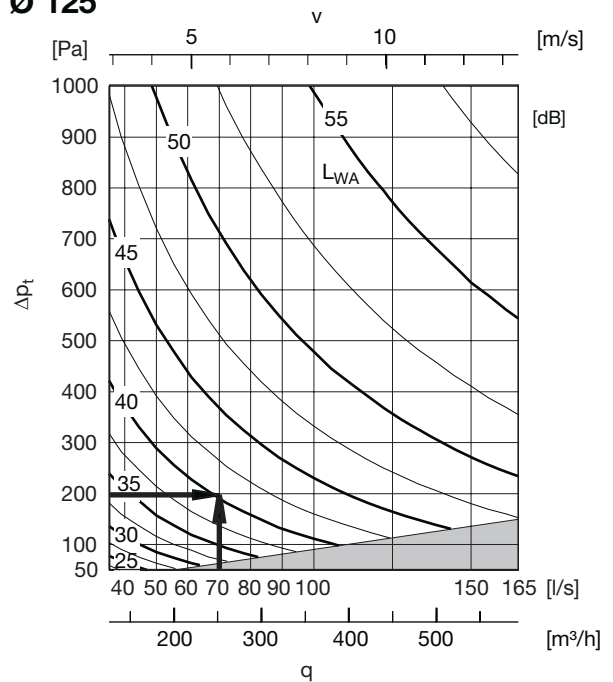

Technical data

DAU, DA2EU, DAVU

Technical data

Pressure and flow ranges and sound to the surroundings

Ø 160

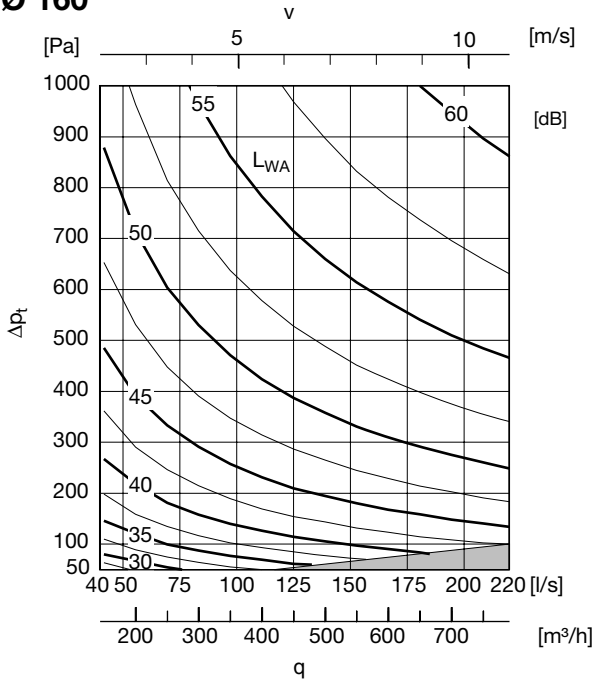

Ø 250

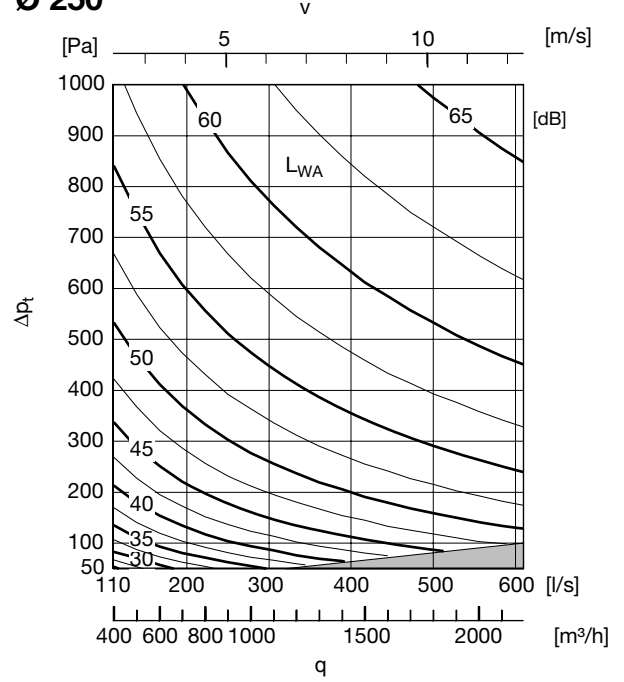

Ø 200

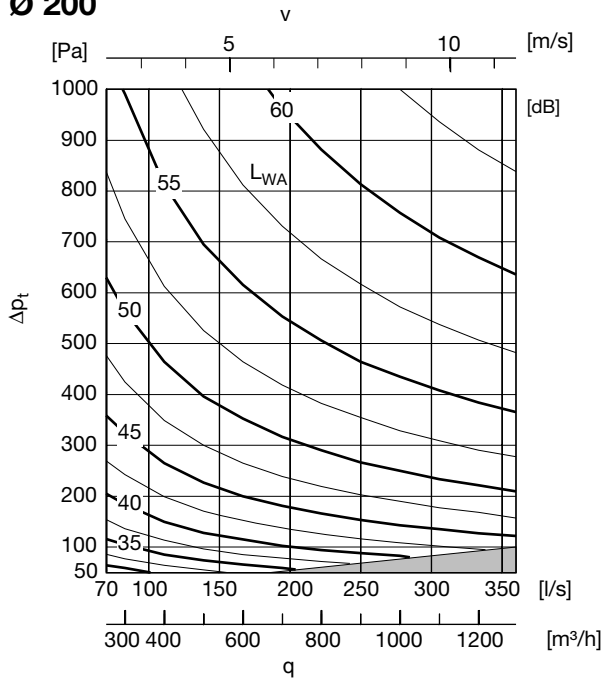

Ø 315

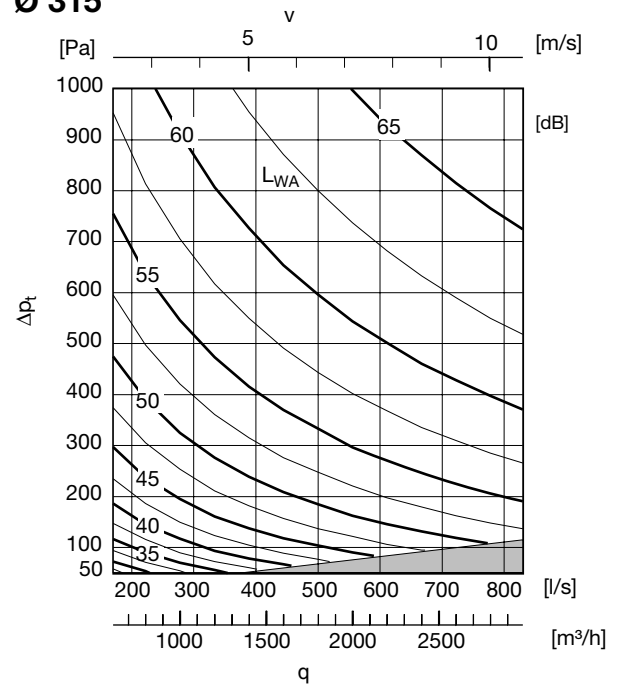

- 1
- 2
- 3
- 4
- 5
- 6
- 7
- 8
- 9
- 10
- 11
- 12
- 13
- 14
- 15
- 16
- 17
- 18