

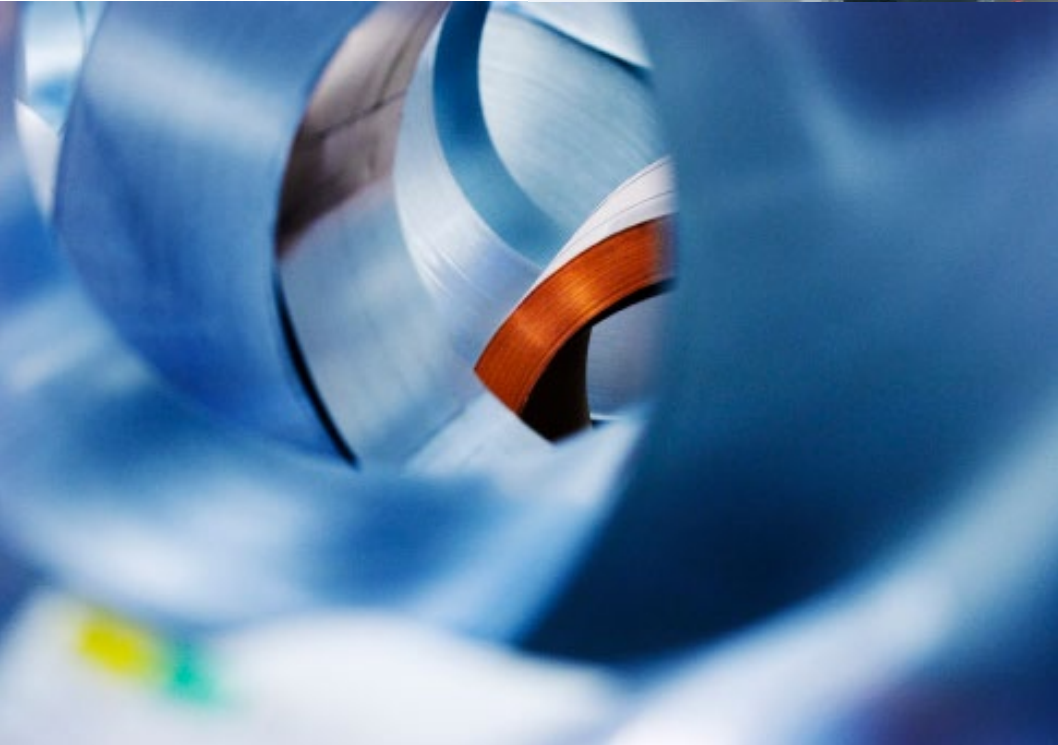

Lindab **General information and theory**



We simplify construction

At Lindab we are driven by a strong desire to continuously generate improvements and to simplify construction. We do that by developing products and systems that are easy to use and energy efficient, together with industry-leading knowledge, support, logistics and efficient availability. We want to simplify everything – from designing, ordering, delivery, goal achievement and installation to the entire way of doing business with us. By simplifying in every stage of the construction process, we also contribute to energy-efficiency.

A good thinking company

Good thinking is a deeply rooted philosophy that guides us in everything we do. We firmly believe that good thinking makes good solutions to the challenges we all face. Taking responsibility for what we do and how we do things is therefore important to us. Because good thinking is not only about making life easier and more comfortable for our customers and end users. It is also a matter of thinking in a global perspective, all the time. Knowing that we at Lindab are helping to make the world a better place.

Eurovent certification

Lindab's circular duct system with rubber gasket connections Lindab Safe and Lindab Safe Click is certified to strength and leakage in tightness class D according to the Eurovent Certified Performance program for circular metallic ducts systems (DUCT-MC). Check ongoing validity of certificate:

www.eurovent-certification.com



The purpose of Eurovent third party Certification is to create a common set of criteria to all relevant features for the rating of products in this system and ensure the

constancy of performance over time.

Through specification of **products in Lindab's certified system, Lindab Safe and Lindab Safe Click**, the engineer's tasks become easier, since there is no need to carry out detailed comparison and performance qualification testing. Consultants, specifiers and users can select products with the assurance that the catalogue data are accurate to a certain level.

Lindab products that are Eurovent certified have the Eurovent logotype in the footer of the technical documentation.

Note: Most Lindab Safe and Lindab Safe Click and the most commonly used product in a ventilation system are essentially better than class D, however some products are according to EN 15727 not class D as a single product. These products are stated in the documentation as Class C and can be used in D class systems to a limited extension.

lindQST – Lindab Quick Selection Tool

lindQST is an advanced web tool that makes the selection of our solutions quick and simple.

With lindQST all documentation is made available directly on the web. That means consultants, installers and architects always have access to the latest documentation, installation instructions and product images etc. lindQST is a unique online tool where you can simulate your room in the Indoor Climate Designer, keep track of your projects

and share it with your business partners etc. lindQST provides a simple shortcut to Lindab's material and is a tool that speeds up and simplifies the daily work.



Content

Dimensions.....	5
Designations and examples.....	5
Length	6
Angle	6
Fittings.....	6
Weight	6
Sheet metal thickness.....	6
Ducts.....	6
Materials.....	7
Corrosivity classes according to	
ISO 12944-2 with environmental examples	7
Sheet metal quality	7
Sheet metal thicknesses.....	8
Galvanic corrosion	8
Temperature limits for our materials	9
Resistance of the Safe system to various substances	10
The SI system.....	15
Units	15
Some basic units.....	15
Some derived units	15
For pressure	15
Some additional units	15
Some multiple prefixes	15
Conversion factors.....	16
Pressure	20
Total pressure = dynamic pressure + static pressure	20
Pressure drop.....	21
Pressure drop calculation	22
Prerequisites	23
Designations used	23
Sound.....	24
About silencers	24
Method of measurement.....	24
Attenuation material and cleaning of the silencers.....	24
Ventilation does not have to be noisy!	25
Choosing silencers	32

Dimensions

The dimension range, measures, colours and ways of how to build the products shown in this catalogue are general and the most frequent ones. Please be aware of that local variations may occur.

Designations and examples

These designations and dimensions of ducts and fittings are adapted to CEN standards.

Lengths are given in mm.

Angles are given in degrees.

Fittings with $\varnothing d_1 - \varnothing d_4$ fit inside ducts and fittings with $\varnothing d$.

Duct and female dimension..... $\varnothing d$

Connector dimension..... $\varnothing d_1, \varnothing d_2, \varnothing d_3, \varnothing d_4$

Sheet metal thickness t

Installation length..... l, l_1, l_2, l_3

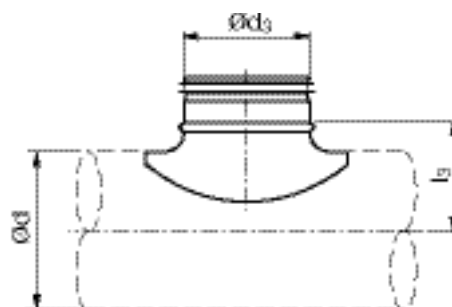
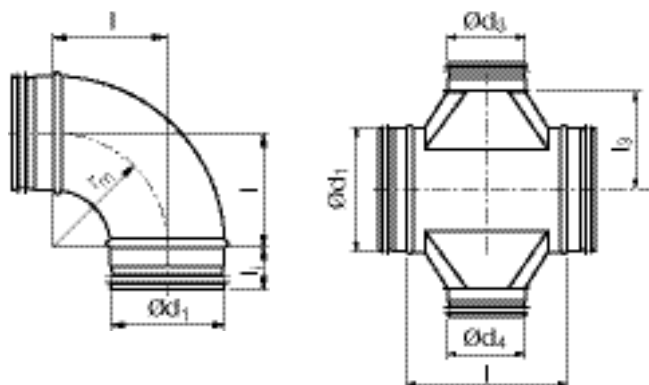
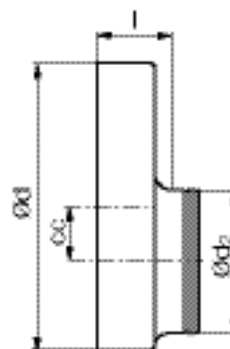
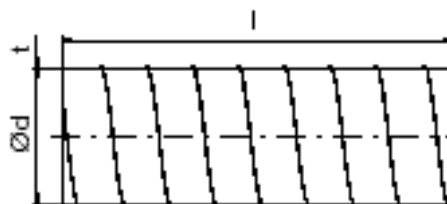

Bend radius..... r_m

Insertion length l_i

Eccentricity cc

Component length L

Circumference..... O

Cross-sectional area..... A_C

Mass..... m

Linear mass..... m_l

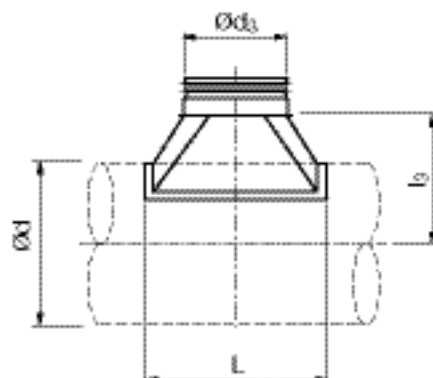

Tolerances

The measures on this page are principally applicable to our "old" range of products mainly manufactured of sheet metal. The measures cannot unreflectingly be regarded as valid for "any" product e.g. flexible ducts.

Bold face denotes standard dimensions.

Standard face denotes intermediate dimensions.

Ducts

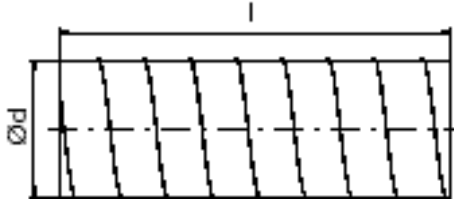

According to EN1506

Ød nom	Tolerance range	
63	63,0	- 63,5
80	80,0	- 80,5
100	100,0	- 100,5
112	112,0	- 112,5
125	125,0	- 125,5
140	140,0	- 140,6
150	150,0	- 150,6
160	160,0	- 160,6
180	180,0	- 180,7
200	200,0	- 200,7
224	224,0	- 224,8
250	250,0	- 250,8
280	280,0	- 280,9
300	300,0	- 300,9
315	315,0	- 315,9
355	355,0	- 356,0
400	400,0	- 401,0
450	450,0	- 451,1
500	500,0	- 501,1
560	560,0	- 561,2
600	600,0	- 601,2
630	630,0	- 631,2
710	710,0	- 711,5
800	800,0	- 801,6
900	900,0	- 902,0
1000	1000,0	- 1002,0
1120	1120,0	- 1122,5
1250	1250,0	- 1252,5
1400	1400,0	- 1402,8
1500	1500,0	- 1502,9
1600	1600,0	- 1603,1

Fittings

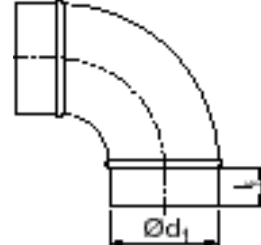

According to EN1506

Ød ₁ , d ₂ , d ₃ , d ₄ nom	Tolerance range		l _i nom
63	61,8	- 62,3	40
80	78,8	- 79,3	40
100	98,8	- 99,3	40
112	110,8	- 111,3	40
125	123,8	- 124,3	40
140	138,7	- 139,3	40
150	148,7	- 149,3	40
160	158,7	- 159,3	40
180	178,6	- 179,3	40
200	198,6	- 199,3	40
224	222,5	- 223,3	40
250	248,5	- 249,3	60
280	278,4	- 279,3	60
300	298,4	- 299,3	60
315	313,4	- 314,3	60
355	353,3	- 354,3	60
400	398,3	- 399,3	80
450	448,2	- 449,3	80
500	498,2	- 499,3	80
560	558,1	- 559,3	80
600	598,1	- 599,3	80
630	628,1	- 629,3	80
710	708,0	- 709,3	100
800	798,0	- 799,3	100
900	897,9	- 899,3	100
1000	997,9	- 999,3	120
1120	1117,8	- 1119,3	120
1250	1247,8	- 1249,3	120
1400	1397,3	- 1398,8	150
1500	1496,9	- 1498,5	150
1600	1596,5	- 1598,2	150

Length

l, l ₁ , l ₃ , etc	Tolerance
0-15	+0 -2
16-100	+0 -5
101-	+0 -10
L	±5

Angle

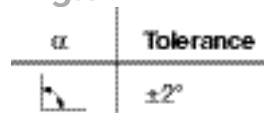

Weight

±10%

Sheet metal thickness

As in sheet metal standard EN 10143

Materials

Corrosivity categories according to ISO 12944-2 with environmental examples

Corrosivity category	Corrosivity	Examples of typical environments (informative only)	
		Exterior	Interior
C1	Very low	-	Heated buildings with clean atmosphere, e.g. offices, shops, schools, hotels.
C2	Low	Atmospheres with low level of pollution: mostly rural areas.	Unheated buildings where condensation can occur, e.g. depots, sports halls.
C3	Medium	Urban and industrial atmospheres, moderate sulfur dioxide pollution; coastal areas with low salinity.	Production rooms with high humidity and some air pollution, e.g. food-processing plants, laundries, breweries, dairies.
C4	High	Industrial areas and coastal areas with moderate salinity.	Chemical plants, swimming pools, coastal ship and boatyards.
C5	Very high	Industrial areas with high humidity and aggressive atmosphere and coastal areas with high salinity.	Buildings or areas with almost permanent condensation and with high pollution.
CX	Extreme	Offshore areas with high salinity and industrial areas with extreme humidity and aggressive atmosphere and subtropical and tropical atmospheres.	Industrial areas with extreme humidity and aggressive atmosphere.

Sheet metal quality

Galvanized

Fittings and ducts from Lindab Ventilations standard programme are manufactured from zinc coated sheet metal. This means that the base material shall be hot dipped zinc galvanized steel sheet metal with a yield point of approx. 200 N/mm², and that the galvanization shall be minimum as class Z 275. This surface treatment corresponds to the corrosivity category C3.

The following material is used in the standard range:

Ducts and hand made fittings are made with material to EN 10346 – DX51D M-A-C.

Pressed fittings are made with material to EN 10346 – DX54D M-B-C.

Galvanized steel - recycled (>75%)

Lindab ventilation offers galvanized duct systems with a large proportion of recycled steel. The performance of the steel is the same as the standard program according to EN 10346 – DX51D M-A-C.

Fittings made from galvanized recycled steel are normally handmade.

Stainless steel

Is divided into two grades.

The lowest grad is according to EN 1.4301 (AISI 304) and complies with the requirements for corrosivity class C4.

The higher grad is according to EN 1.4404 (AISI 316L) and complies with the requirements for corrosivity class C5.

Some fitting which are normally pressed are handmade and folded together.

Zinc-Magnesium

With surface treatment to ZM 310 means 310 g zincmagnesium/m² double sided, which complies with the requirements of corrosivity category C5. Normally pressed fittings are handmade and folded together.

Aluminium-Zinc

With surface treatment to AZ 185 means 185 g aluminium-zinc/m² double sided, which complies with the requirements of corrosivity category C4. The sheet metal is treated with Anti-fingerprint, which protects against fingerprints during production and assembly. Normally pressed fittings are handmade and folded together.

Aluminium

To ISO/DIS 209-1. Complies with the requirements of corrosivity category C4 without surface coating. Normally pressed fittings are handmade and folded together.

Painted

Products are made, as standard, from hot dip galvanized steel sheet and then powder coated internally and externally with a mixed powder consisting of epoxy and polyester (PE) to a thickness of 80 µm. Standard painted

Materials

products comply with the requirements of corrosivity category C4.

Standard colors are:

NCS S0502-y, gloss 30 which is equivalent to RAL 9010

NCS S1002-G, gloss 30 which is equivalent to RAL 9003

The gloss is defined by the Gardner 60° scale. Other colors can be made on request.

NOTE! For ducts of Ø 100 the maximum length is 1,5 m for internal coating.

Products can be coated on the inside only, for hygienic or liquid tightness reasons, or on the outside for aesthetic reasons. The standard outside coated color for aesthetic reasons is NCS S1002-G, gloss 30 which is equivalent to RAL 9003. These products are available as stock items for a limited circular duct assortment, called EVIT.

Powder coating can be optionally obtained in thicknesses of up to 200 µm. Products painted with mix powder, epoxy and polyester, can after some time of exposure to UV radiation receive changes in color. Hence storage in sunlight ought to be avoided.

Thickness of the surface

A surface treatment to class Z 275 is defined in EN 10346 and means 275 g zinc/m² double sided. Z 275 thus tells the total amount of zinc on both sides of a 1 m² sheet metal plate. The thickness can thus be calculated as:

$$\text{Zinc thickness} = \frac{\text{zinc weight}}{\text{number of sides} \cdot \text{zinc density}} = \frac{0,275}{2 \cdot 7140} \cdot 10^6 = 19 \mu\text{m}$$

Sheet metal thicknesses

The sheet metal thickness tolerances is defined in EN 10143. The thickness of each product is chosen by Lindab to withstand normal use in ventilation, handling on trucks, building places and during mounting of the system. If there is special requirement for thicker material the inner diameter of the ducts will be smaller and special arrangements can be needed.

Galvanic corrosion

The starting point for galvanic corrosion is that you always need 4 components:

- An anode, i.e. the less noble material
- A cathode, i.e. the more noble material
- A galvanic connection, i.e. an electrolyte, basically water with (some) salts
- Electrical contact between the anode and cathode

If any of these 4 are missing, you will not have galvanic corrosion. Often the easiest way is to take away the electrical contact between anode and cathode.

We make a difference between the material with the large surface area (the panel example ducts), and the material with the small surface area (example: flanges, hangers, screws).

Our general recommendation can be found in the table below. The table should be a tool for choosing materials that in most cases can be assembled together, but there are many parameters that must collaborate, which makes it difficult to be sure that it works in all situations.

Galvanic corrosion table

		Material with a small surface					
		Galvanized	Aluminium-Zinc (AZ)	Zinc-Magnesium (ZM)	Stainless	Aluminium	Painted (Galv + powder coated)
Material with a large surface	Galvanized	+	+	+	+	+	+
	Aluminium-Zinc (AZ)	-	+	-	+	+	+
	Zinc-Magnesium (ZM)	+	-	+	+	-	+
	Stainless	-	-	-	+	-	+
	Aluminium	+	-	-	+	+	+
	Painted (Galv + powder coated)	+	+	+	+	+	+

+ No known problems with the combination

- Avoid

Materials

Temperature limits for our materials

The shaded cells mark standard design.

The measures on this page are principally applicable to our "old" range of products mainly manufactured of sheet metal.

The measures cannot unreflectingly be regarded as valid for "any" product e.g. flexible ducts.

Product	Material/type	Operation			
		Continuous		Intermittent	
		Temperature limit			
		min °C	max °C	min °C	max °C
Pressed and seam welded	Galvanized steel sheet metal		200 ¹		250 ²
	Aluminium sheet metal		200 ³		300
	Stainless steel sheet metal		500		700
	Zinc-Magnesium sheet metal		100		150
	PE/EP coated products		80		100
	Aluzink sheet metal		315		
Swaged, spot welded and/or blind interlocked joint	Acrylic mastic	-40	70		
	Silicone mastic		150		200
Safe gasket and damper blade seals	EPDM rubber	-30	100	-50	120
	Silicone rubber	-70	150	-90	200
Foam rubber seal	EPDM rubber	-30	100	-50	120
Foam plastic gasket	Polyester	-40	70		
Measuring nozzle	Plastic		70		
Damper shaft bearings	Polyamide	-30	150	-50	200
	Brass		300		
Damper actuator	Electric	-30	50		
	Pneumatic	-5	60		
Duct filter	Polyester		100		
Drain hose	Ethylene vinyl acetate and polyethylene	-45	65		
Insulation	Glass wool		200		
	Rock wool		700		
	Rock wool, paper lined		80		
Silencer	Polyester		130		180

1. Discoloration occurs at about 200 °C in galvanized steel. This is mostly an appearance problem and does not mean impair corrosion protection in a normal environment.
2. If the temperature rises to about 300 °C, the adhesion of the zinc is impaired, which means poorer corrosion protection.
3. Aluminium sheet will soften after a couple of years at 200 °C.

Materials

Resistance of the Safe system to various substances

The table gives a rough guide to how some of the materials used in the Safe system resist various substances.

Affection	Recommendation	Code
Scarcely affected	Recommended	4
Lightly affected	Normally usable	3
Strongly affected	Only usable in certain cases	2
Badly affected	Unsuitable	1
Information missing		–

Substance	details	Materials			Substance	details	Materials		
		EPDM rubber	Silicone rubber	Galvanized sheet metal			EPDM rubber	Silicone rubber	Galvanized sheet metal
A Acetaldehyde		4	4	4	Barium sulfide		4	–	–
Acetamide		4	–	–	Beer		4	4	4
Acetic	anhydride	3	2	4	Beet sugar liquors		4	–	–
Acetic acid	30 %	4	3	4	Benzaldehyde		4	–	–
Acetic acid	10 %, 50 °C	2	–	–	Benzene, benzole		1	1	4
Acetic acid	25 %, 100 °C	1	–	–	Benzenesulfonic acid		–	–	–
Acetic acid	50 %, 50 °C	1	–	–	Benzoic acid		–	–	–
Acetic acid	crystalline acetic acid	4	3	4	Benzyl alcohol		3	–	–
Acetone		4	3	4	Benzyl benzoate		3	–	–
Acetonitrile		4	–	–	Benzyl chloride		–	–	–
Acetophenone		4	–	–	Black liquor		1	–	–
Acetyl chloride		–	–	–	Black water, waste water		4	3	4
Acetylene		4	3	4	Blast furnace gas		–	–	–
Acrylonitrile		1	–	–	Bleach solutions		4	–	–
Adipic acid		–	–	–	Borax		4	3	4
Air	70 °C	4	–	–	Bordeaux mixture		4	–	–
Air	100 °C	4	–	–	Boric acid		4	4	2
Air	150 °C	3	–	–	Boron fuels		–	–	–
Air	200 °C	2	–	–	Brake fluid	vegetable, 50 °C	4	–	–
Alkazene		1	–	–	Brine		4	–	–
Alum		4	4	4	Bromic acid		4	1	1
Aluminium acetate		4	–	–	Bromide	liquid	–	1	1
Aluminium chloride		4	–	–	Bromine	anhydrous	–	–	–
Aluminium fluoride		4	–	–	Bromine trifluoride		1	–	–
Aluminium nitrate		4	4	2	Bromine water		–	–	–
Aluminium phosphate		4	–	–	Bromobenzene		1	–	–
Aluminium sulfate		4	–	–	Butadiene		2	–	–
Ammonia	liquid, anhydrous	4	–	–	Butane		1	4	4
Ammonia gas	cold	4	4	3	Butanol, butyl alcohol	50 °C	4	3	4
Ammonia gas	hot	3	3	3	Butanol, butyl alcohol	100 °C	–	–	–
Ammonium carbonate		4	–	–	Butter		4	–	–
Ammonium chloride		4	–	–	Butter	water free, 100 °C	2	–	–
Ammonium hydroxide		4	3	3	Butyl acetate		3	1	4
Ammonium nitrate		4	3	3	Butyl acetyl ricinoleate		4	–	–
Ammonium persulfate		4	–	–	Butyl acrylate		1	–	–
Ammonium phosphate		4	–	–	Butyl alcohol		3	–	–
Ammonium sulfate		4	–	–	Butyl amine		1	–	–
Amyl acetate		4	1	4	Butyl benzoate		4	–	–
Amyl alcohol, pentanol		4	–	–	Butyl carbitol		4	–	–
Amyl borate		1	–	–	Butyl cellosolve		4	–	–
Amyl chloronaphtalene		1	–	–	Butyl oleate		3	–	–
Amyl naphtalene		1	–	–	Butyl stearate		3	–	–
Aniline		3	–	4	Butylaldehyde		3	–	–
Aniline dye		3	–	4	Butylene		1	–	–
Aniline hydrochloride		3	–	–	C Calcium acetate		4	–	–
Animal fats		3	3	4	Calcium bisulfite		1	–	–
Ansul ether		2	–	–	Calcium chloride		4	–	–
Aqua regia		2	–	–	Calcium hydroxide		4	–	–
Arochlor		2	–	–	Calcium hypochlorite		4	–	–
Arsenic acid		4	4	3	Calcium nitrate		4	3	3
Arsenic trichloride		–	–	–	Calcium sulfide		4	–	–
Asphalt		1	1	1	Cane sugar liquors		4	–	–
Astm oil	No 1	1	–	–	Carbamate		3	–	–
Astm oil	No 2	1	–	–	Carbitol		3	–	–
Astm oil	No 3	1	–	–	Carbolic acid, phenol		3	–	–
B Barium chloride		4	–	–	Carbon acid		4	–	–
Barium hydroxide		4	–	–	Carbon bisulfide		1	–	–
Barium sulfate		4	4	3	Carbon dioxide		3	–	–

Materials

Substance	details	Materials			Substance	details	Materials		
		EPDM rubber	Silicone rubber	Galvanized sheet metal			EPDM rubber	Silicone rubber	Galvanized sheet metal
Carbon monoxide		4	-	-	Diisopropyl ketone		4	-	-
Carbon tetrachloride		1	-	-	Dilutin, white spirit		1	1	4
Castor oil		3	-	-	Dimethyl aniline		3	-	-
Cellosolve acetate		3	-	4	Dimethyl formamide, DMF		3	-	-
Cellosolve, ethylene glycol		3	-	4	Dimethyl phtalate		3	-	-
Chlorine	dry	2	-	1	Dinitrotoluene		1	-	-
Chlorine	wet	2	-	1	Diocetyl phtalate		3	-	-
Chlorine dioxide		2	-	-	Diocetyl sebacate		3	-	-
Chlorine trifluoride		1	-	-	Dioxalane		3	-	-
Chloro 1-nitroethane		1	-	-	Dioxane		3	-	-
Chloroacetic acid		3	-	-	Dipentene		1	-	-
Chloroacetone		4	-	-	Diphenyl oxides		4	-	-
Chloroacetone acid		3	-	-	Diphenyl, biphenyl		1	-	-
Chlorobenzene		1	-	-	Dry cleaning fluids		1	-	-
Chlorobromomethane		3	-	-	E Epichlorohydrin		3	-	-
Chlorobutadiene		1	-	-	Ethane		1	-	4
Chlorododecane		1	-	-	Ethanolamine		3	-	-
Chloroform		1	-	-	Ethyl acetate		3	2	4
Chloronaphthalene		1	-	-	Ethyl acetoacetate		3	-	-
Chloroprene		1	-	-	Ethyl acrylate		3	-	-
Chlorosulfonic acid		1	1	1	Ethyl alcohol		4	4	4
Chlorotoluene		1	-	-	Ethyl benzene		1	-	-
Chrome plating solutions		1	-	-	Ethyl benzoate		3	-	-
Chromic acid		2	2	1	Ethyl cellosolve		3	-	-
Chromic acid	10 %, 50 °C	1	-	-	Ethyl cellulose		3	-	-
Citric acid		4	4	3	Ethyl chloride		4	1	-
Cobalt chloride		4	-	-	Ethyl chlorocarbonate		-	-	-
Cocoonut oil		4	-	-	Ethyl chloroformate		-	-	-
Cod liver oil		4	-	-	Ethyl ether		2	-	4
Coke oven gas		1	-	-	Ethyl formate		3	-	-
Copper acetate		4	-	-	Ethyl glycol, cellosolve		3	-	4
Copper chloride		4	4	1	Ethyl mercaptan		1	-	-
Copper cyanide		4	-	-	Ethyl oxalate		4	-	-
Copper sulfate		4	-	-	Ethyl pentochlorobenzene		1	-	-
Corn oil		2	-	-	Ethyl silicate		4	-	-
Cottonseed oil		4	-	-	Ethylene		-	-	-
Creosote		1	-	-	Ethylene chloride		2	-	-
Cresol		1	-	-	Ethylene chlorohydrin		-	-	-
Cresylic acid		1	-	-	Ethylene diamine		4	-	-
Cumene		-	-	-	Ethylene dichloride		2	-	-
Cyclohexane		1	-	-	Ethylene glycol		4	3	4
Cyclohexanol		1	-	-	Ethylene oxide		2	-	-
Cyclohexanone		3	-	-	Ethylene trichloride		2	-	-
D Decalin		-	-	-	F Fatty acids		1	-	-
Decane		-	-	-	Ferric chloride		4	-	-
Denatured alcohol		4	-	-	Ferric nitrate		4	-	-
Detergent solutions		4	4	3	Ferric sulfate		4	-	-
Developing fluids		3	-	4	Fish oil		-	-	-
Diacetone		4	-	-	Fluoric silicate		4	2	2
Diacetone alcohol		4	-	-	Fluorinated cyclic ethers		4	-	-
Dibenzyl ether		3	-	-	Fluorine	liquid	2	-	-
Dibenzyl sebacate		3	-	-	Fluorobenzene		1	-	-
Dibutyl amine		1	-	-	Fluoroboric acid		4	-	-
Dibutyl ether		2	-	-	Fluorocarbon oils		4	-	-
Dibutyl phtalate		4	-	-	Fluorochloroethylene		-	-	-
Dibutyl sebacate		3	-	-	Fluorosilic acid		-	-	-
Dichloro isopropyl ether		2	-	-	Formaldehyde, formalin	40 %	4	-	4
Dichlorobenzene		1	-	-	Formaldehyde, formalin	40 %, 70 °C	-	-	-
Dicyclohexylamine		1	-	-	Formic acid		4	2	-
Diesel oil		1	2	4	Formic acid	70 °C	3	-	3
Diester oil, fluid 101		-	-	-	Freon	11	1	1	4
Diethyl benzene		1	-	-	Freon	12	3	1	4
Diethyl ether		1	-	-	Freon	13	4	-	4
Diethylamine		3	-	-	Freon	13 B 1	4	-	-
Diethylbenzene		1	-	-	Freon	21	1	-	4
Diethylene glycol		4	-	-	Freon	22	4	1	4
Diethylsebacate		3	-	-	Freon	31	4	-	4
Diisobutylene		-	-	-	Freon	32	4	-	4
Diisopropyl benzene		1	-	-	Freon	112	1	-	4
Diisopropyl ether		1	-	-	Freon	113	1	1	4

Materials

Substance	details	Materials			Substance	details	Materials		
		EPDM rubber	Silicone rubber	Galvanized sheet metal			EPDM rubber	Silicone rubber	Galvanized sheet metal
Freon	114	4	1	4	Iodine pentafluoride		1	-	-
Freon	114 B 2	1	-	-	Iodoform		4	-	-
Freon	115	4	-	4	Iron salts	non-oxidizing	4	3	3
Freon	142 b	4	-	-	Isoamyl alcohol		4	-	-
Freon	152 a	4	-	-	Isobutyl alcohol		4	-	-
Freon	218	4	-	-	Isoforon		4	-	-
Freon	502	-	-	-	Isooctane, fuel A		1	-	-
Freon	BF	-	-	-	Isooctane/toulene, fuel B and C		-	-	-
Freon	C 316	4	-	-	Isopropyl acetate		4	-	-
Freon	C 318	4	-	-	Isopropyl alcohol		4	-	-
Freon	MF	-	-	-	Isopropyl chloride		1	-	-
Freon	TA	4	-	-	Isopropyl ether		1	-	-
Freon	TC	3	-	-	Isopropyl nitrate		3	-	-
Freon	TF	1	-	-	K Kerosene		1	-	-
Freon	TMC	3	-	-	L Lacquer solvents		1	-	-
Freon	T-P35	4	-	-	Lacquers		1	-	-
Freon	T-WD 602	3	-	-	Lactic acid		4	4	4
Fuel B	70 % isooctane, 30 % toulene	1	-	-	Lard		1	-	-
Fuel C	50 % isooctane, 50 % toulene	1	-	-	Lavender oil		1	-	-
Fuel oil, bunker oil, diesel oil		1	-	-	Lead acetate		4	-	-
Fuel oil, bunker oil, diesel oil	70 °C	1	-	-	Lead nitrate		4	2	2
Fumaric acid		-	-	-	Lead sulfamate		4	-	-
Furan, furfuran		2	-	4	Lime bleach		4	-	-
Furfural		3	-	4	Lime sulfur		4	-	-
G Gallic acid		3	-	-	Linoleic acid		1	-	-
Gasohol	50 % toulene, 30 % isooctane, 20 % methanol	1	-	-	Linseed oil		3	4	4
Gasoline		1	-	-	Liquid manure		4	3	3
Gelatine		4	-	-	Lubricating oils (Petroleum)		1	1	4
Glaubers salt		3	-	-	Lye		4	-	-
Glucose		4	4	4	M Magnesium chloride		4	4	3
Glycerin		4	4	4	Magnesium hydroxide		4	-	-
Glycerol, glycerine		4	-	-	Magnesium sulfate		4	-	-
Glycolmonoethylether, cellosolve		3	-	-	Maleic acid		2	-	-
Glycolmonoethyletheracetate, cellosolveacetate		4	-	-	Maleic anhydride		2	-	-
Glycolmonoethyletherbutyl, butylcellosolve		4	-	-	Malic acid		1	-	-
Glycols		4	-	-	Manganese salts	non-oxidizing	4	4	3
Green liquor		4	3	2	Mercuric chloride		4	-	-
H Halowax oil		1	-	-	Mercury		4	4	4
Heating oil		1	2	4	Mercury salts	non-oxidizing	4	4	3
Heptane		1	-	-	Mesityl oxide		3	-	-
Hexachlorobutadiene		1	-	-	Methacrylacidmethylester	125 °C	3	-	-
Hexaldehyde		4	-	-	Methane		1	-	-
Hexane		1	-	-	Methyl acetate		3	-	-
Hexyl alcohol, hexanol		2	-	-	Methyl acrylate		3	-	-
Hydraulic oil	mineral oil based	1	3	4	Methyl alcohol, methanol, wood alcohol		4	4	4
Hydraulic oil	phosphate ester based	4	4	4	Methyl bromide		-	-	-
Hydrazine		4	-	-	Methyl butyl keton		4	-	-
Hydrochloric acid	dilute	4	1	-	Methyl cellosolve		3	-	-
Hydrochloric acid	37 %	4	1	2	Methyl chloride		2	1	4
Hydrochloric acid	37 %, 70 °C	2	1	-	Methyl cyclopentane		1	-	-
Hydrochloric acid	10 %, 100 °C	1	-	-	Methyl ethyl ketone, MEK		4	-	4
Hydrocyanic acid		4	-	-	Methyl formate		3	-	-
Hydrofluoric acid	anhydrous	2	-	-	Methyl glycol acetate	50 °C	-	-	-
Hydrofluoric acid	concentrated, cold	3	1	2	Methyl isobutyl ketone		3	2	4
Hydrofluoric acid	concentrated, hot	1	1	1	Methyl isopropyl ketone		3	2	4
Hydrofluorosilic acid		4	1	2	Methyl methacrylate		1	-	-
Hydrogen gas		4	4	4	Methyl oleate		3	-	-
Hydrogen peroxide	3 %	4	4	4	Methyl salicylate		3	-	-
Hydrogen peroxide	30 %, 20 °C	4	4	4	Methylacrylic acid		3	-	-
Hydrogen peroxide	90 %, 20 °C	2	4	4	Methylene chloride		1	1	4
Hydrogen sulphide	dry	4	4	3	Methylene dichloride		2	-	-
Hydrogen sulphide	damp	4	2	-	Milk		4	4	4
Hydrogen sulphide	damp, hot	3	1	-	Mineral oil		1	-	-
Hydroquinone		-	-	-	Monobromobenzene		-	-	-
Hypochlorous acid		3	-	-	Monochlorobenzene		1	-	-
I Iodine		-	-	3	Monoethanolamine		3	-	-
					Monomethyl aniline		-	-	-
					Monomethylether		4	-	-
					Monovinyl acetylene		4	-	-
					Mustard gas		4	-	-

Materials

Substance	details	Materials			Substance	details	Materials		
		EPDM rubber	Silicone rubber	Galvanized sheet metal			EPDM rubber	Silicone rubber	Galvanized sheet metal
N Naphta		1	-	-	Potassium hydroxide		4	3	2
Naphtalene		1	-	-	Potassium hypochlorite pH 7, below 10 g/l		4	1	4
Naphtenic acid		1	-	-	Potassium hypochlorite over 10 g/l		3	1	4
Natural gas		1	4	4	Potassium nitrate		4	-	-
Nickel acetate		4	-	-	Potassium permanganate 25 %, 70 °C		1	-	-
Nickel chloride		4	-	-	Potassium sulfate		4	3	4
Nickel sulfate		4	-	-	Producer gas		1	-	-
Nitric acid	20 %	4	-	2	Propane/butane, LPG		1	1	4
Nitric acid	20 %, 50 °C	3	1	-	Propyl acetate		3	-	-
Nitric acid	40 %, 50 °C	3	1	-	Propyl alcohol, propanol		4	4	4
Nitric acid	50 %, 50 °C	2	1	-	Propyl amine		2	-	-
Nitric acid	60 %	2	1	-	Propyl nitrate, isopropyl nitrate		3	-	-
Nitric acid	70 %	1	1	-	Propylene oxide		3	-	-
Nitric acid	red fuming	1	1	-	Propylene, propene		1	-	-
Nitrobenzene		3	1	4	Pydraul F-9, phosphate ester 80 °C		3	-	-
Nitrobenzine		2	-	-	Pyridine		3	-	-
Nitroethane		3	-	-	Pyroligneuos acid		3	-	-
Nitrogen		4	4	4	Pyrrole		2	-	-
Nitrogen		4	-	-	R Radiation		3	2	4
Nitrogentetroxide		2	-	-	Rapeseed oil, canola oil		4	4	4
Nitrogentetroxide		2	-	-	Rapeseed oil, canola oil 100 °C		3	-	-
Nitromethane		3	-	-	Rosin oil		1	1	4
Nitropropane		4	-	-	S Sal ammoniac		4	-	-
Nitrous gases		2	2	4	Salicylic acid		4	4	4
O Octachlorotoluene		1	-	-	Salt water		4	-	-
Octadecane		1	-	-	Salts (inorganic) and salt solutions saturated, 70 °C		4	-	-
Octane		1	-	-	Sewage		3	-	-
Octanol		4	-	-	Silicate esters		1	-	-
Octyl alcohol		4	-	-	Silicone greases		4	-	-
Oleic acid		3	-	4	Silicone oils		4	-	-
Oleum spirits		-	-	-	Silver nitrate		4	-	-
Olive oil		3	3	4	Skydrol 500		4	-	-
Oxalic acid		4	3	1	Skydrol 7000		4	-	-
Oxidizing salt solution (KMnO4)25 %, 70 °C		1	-	-	Soap solutions		4	-	-
Oxygen	cold	4	4	4	Soda ash		4	-	-
Oxygen	90-200 °C	1	-	-	Sodium acetale		4	-	-
Ozone		4	4	2	Sodium bicarbonate		4	-	-
P Palmitic acid		3	-	4	Sodium bisulfite		4	-	-
Paraffine, kerosine		1	1	4	Sodium borate		4	-	-
p-Cymene		1	-	-	Sodium carbonate 20 %, 100 °C		4	-	-
Peanut oil		2	-	-	Sodium chloride		4	-	-
Pentanol, amyl alcohol		4	-	-	Sodium cyanide		4	-	-
Perchloric acid		3	1	1	Sodium hydroxide, sodium hydrate, caustic soda		4	2	1
Perchloroethylene		1	3	4	Sodium hypochlorite max 10 g/l free Cl		4	-	4
Petroleum oils		1	1	4	Sodium hypochlorite over 10 g/l free Cl		3	-	4
Petroleum, petrol		1	1	4	Sodium metaphosphate		4	-	-
Phelyn hydrazine		2	-	-	Sodium nitrate		4	4	3
Phenol		3	2	2	Sodium perborate		4	-	-
Phenyl ethyl ether		1	-	-	Sodium peroxide		4	-	-
Phenyl hydrazine		3	-	-	Sodium phosphate		4	-	-
Phenylbenzene		1	-	-	Sodium silicate		4	-	-
Phorone		3	-	-	Sodium sulfate		4	-	-
Phosphoric acid	20 %	4	-	-	Sodium thiosulfate		4	-	-
Phosphoric acid	45 %	3	1	2	Soybean oil		2	-	-
Phosphoric acid	85 %	4	1	1	Stannicous chloride		3	-	-
Phosphoric acid	60 %, 50 °C	4	-	-	Steam	under 150 °C	4	-	-
Phosphorus trichloride		4	-	-	Steam	over 150 °C	3	-	-
Picric acid		3	-	-	Stearic acid		3	-	-
Pine oil		1	-	-	Styrene		1	1	4
Pinene		1	-	-	Sucrose solution		4	4	4
Piperidine		1	-	-	Sulfite liquors		3	-	-
Plating solution	chrome	4	-	-	Sulfur		4	4	4
Plating solution	others	4	3	-	Sulfur chloride		1	-	2
Polyvinylacetate emulsion		4	-	-	Sulfur dichloride		-	-	-
Potassium acetate		4	-	-	Sulfur dioxide		4	3	3
Potassium carbonate		3	-	-	Sulfur hexafluoride		4	-	-
Potassium chloride		4	-	-	Sulfur trioxide		3	2	2
Potassium cupro cyanide		4	-	-	Sulfuric acid	10 %, 100 °C	4	-	-
Potassium cyanide		4	-	-					
Potassium dicromate		4	-	-					

Materials

Substance	details	Materials		
		EPDM rubber	Silicone rubber	Galvanized sheet metal
Sulfurous acid		3	1	3
Sulphuric acid	60 %	4	1	2
Sulphuric acid	60 %, 50 °C	4	1	–
Sulphuric acid	60–75 %, 50 °C	3	1	–
Sulphuric acid	75–80 %, 50 °C	2	1	–
Sulphuric acid	85–96 %, 50 °C	1	1	–
Sulphuric acid	fuming, Oleum	1	1	–
T Tannic acid		4	1	4
Tar	bituminous	1	2	1
Tartaric acid		3	–	–
Terpineol		2	–	–
Tertiary butyl alcohol		3	–	–
Tertiary butyl catechol		3	–	–
Tertiary butyl mercaptan		1	–	–
Tetrabromomethane		1	–	–
Tetrabutyl titanate		4	–	–
Tetrachloroethane		–	–	–
Tetrachloroethylene		1	–	–
Tetraethyl lead		1	–	–
Tetrahydrofuran, THF		3	–	–
Tetralin		1	–	–
Thinner		1	–	–
Thionyl chloride		1	–	–
Titanium tetrachloride		1	–	–
Toluene diisocyanate		4	–	–
Toluene, toluol		1	1	4
Transformer oil	chlorated hydrocarbon	1	1	4
Transformer oil	mineral oil based	1	3	4
Transmission fluid type a		1	–	–
Triacetin		4	–	–
Triaryl phosphate		4	–	–
Tributoxy ethyl phosphate		4	–	–
Tributyl mercaptan		1	–	–
Tributyl phosphate		4	–	–
Trichlorethane, thinner		1	2	4
Trichloroacetic acid		3	–	–
Trichloroethylene		1	–	–
Tricresyl phosphate		4	–	–
Triethanol amine		3	–	–
Triethyl amine		1	–	–
Triethyl borane	70 °C	2	–	–
Trinitrotoluene		1	–	–
Trioctyl phosphate		4	–	–
Tung oil		1	–	–
Turbine oil		1	–	–
Turpentine		1	1	4
V Vegetable oils		3	4	4
Vinyl chloride		3	–	–
W Water	distilled	4	4	4
Water	fresh	4	4	4
Water	fresh and distilled, 100 °C	4	2	4
Water	salt	4	4	2
White liquor		4	3	–
White spirit, dilutin		1	1	4
Wine		4	4	4
X Xylene, xylol		1	1	4
Z Zinc salts	non-oxidizing	4	4	4

The SI system

Units

The SI system (Système International d'Unités) is used in this catalogue, in accordance with international practice. Units may be given in the "technical system" in diagrams and tables, in parallel with the SI system.

Some basic units

For length	metre	m
For mass	kilogramme	kg
For time	second	s
For electric current	ampere	A
For temperature	kelvin	K

Some derived units

For frequency	hertz	Hz	1 Hz	= 1/s
For force	newton	N	1 N	= 1 kg · m/s ²

For pressure

Mechanical stress	pascal	Pa	1 Pa	= 1 N/m ²
For energy, work	joule	J	1 J	= 1 N · m
For power	watt	W	1 W	= 1 J/s
For electric potential, electric tension	volt	V	1 V	= 1 W/A

Some additional units

For time	minute	min	1 min	= 60 s
	hour	h	1 h	= 3 600 s = 60 min
For flat angles	degree	°	1°	= 1/360 of a circle
For volume	litre	l	1 l	= 1 000 cm ³ = 1 dm ³

Some multiple prefixes

Index	Designation	Des.	Example	
10 ¹²	tera	T	1 terajoule	1 TJ
10 ⁹	giga	G	1 gigawatt	1 GW
10 ⁶	mega	M	1 megavolt	1 MV
10 ³	kilo	k	1 kilometre	1 km
10 ²	hecto	h	1 hectogramme	1 hg
10 ¹	deca	da	1 decalumen	1 dalm
10 ⁻¹	deci	d	1 decimetre	1 dm
10 ⁻²	centi	c	1 centimetre	1 cm
10 ⁻³	milli	m	1 milligramme	1 mg
10 ⁻⁶	micro	μ	1 micrometre	1 μm
10 ⁻⁹	nano	n	1 nanohenry	1 nH
10 ⁻¹²	pico	p	1 picofarad	1 pF

The SI system

Conversion factors

Tables for conversion to other dimensions are given for some of the units commonly used in the industry.

Pressure, p

Pa pascal N/m ²	mm wc mm Aq mm H ₂ O	mm Hg (at 20 °C)	in wg " wg in wc	psi(g) ibf/in ²	bar
1	0,102	0,007 53	0,004 02	0,000 145	0,000 010 0
9,79	1	0,073 7	0,039 4	0,001 42	0,000 097 9
133	13,6	1	0,534	0,019 3	0,001 33
249	25,4	1,87	1	0,036 1	0,002 49
6 895	704	51,9	27,7	1	0,068 9
100 000	10 215	753	402	14,5	1

Length, l

in inch	ft foot	yd yard	m metre	mile
1	0,083 3	0,027 8	0,025 4	0,000 015 8
12,0	1	0,333	0,305	0,000 189
36,0	3,00	1	0,914	0,000 568
39,4	3,28	1,09	1	0,000 621
63 360	5 280	1 760	1 609	1

Area, A

in ² sq in	ft ² sq ft	yd ² sq yd	m ² sq metre	ar	ha hectare
1	0,006 94	0,000 772	0,000 645	0,000 006 45	0,000 000 064 5
144	1	0,111	0,092 9	0,000 929	0,000 009 29
1 296	9,00	1	0,836	0,008 36	0,000 083 6
1 550	10,8	1,20	1	0,010 0	0,000 100
155 000	1 076	120	100	1	0,010 0
15 500 031	107 639	11 960	10 000	100	1

Volume, V

in ³ cu in	l litre	US gal gallon	UK gal gallon	ft ³ cu ft	yd ³ cu yd	m ³ cubic metre
1	0,016 4	0,004 33	0,003 60	0,000 579	0,000 021 4	0,000 016 4
61,0	1	0,264	0,220	0,035 3	0,001 31	0,001 00
231	3,79	1	0,833	0,134	0,004 95	0,003 79
277	4,55	1,20	1	0,161	0,005 95	0,004 55
1 728	28,3	7,48	6,23	1	0,037 0	0,028 3
46 656	765	202	168	27,0	1	0,765
61 024	1 000	264	220	35,3	1,31	1

Velocity, v

The SI system

ft/min fpm	km/h Bz	ft/s	mile/h mph	knot kn	m/s
1	0,018 3	0,016 7	0,011 4	0,009 87	0,005 08
54,7	1	0,911	0,621	0,540	0,278
60,0	1,10	1	0,682	0,592	0,305
88,0	1,61	1,47	1	0,869	0,447
101	1,85	1,69	1,15	1	0,514
197	3,60	3,28	2,24	1,94	1

Volume flow, q_v

ft ³ /h cfh	l/min	m ³ /h	ft ³ /min cfm	l/s	m ³ /s
1	0,472	0,028 3	0,016 7	0,007 87	0,000 007 87
2,12	1	0,060 0	0,035 3	0,016 7	0,000 016 7
35,3	16,7	1	0,589	0,278	0,000 278
60,0	28,3	1,70	1	0,472	0,000 472
127	60,0	3,60	2,12	1	0,001 00
127 133	60 000	3 600	2 119	1 000	1

Mass, m

oz ounce	lb pound	kg kilogramme
1	0,062 5	0,028 3
16,0	1	0,454
35,3	2,20	1

Mass flow, q_m

lb/min	kg/s
1	0,007 56
132	1

Density, ρ

kg/m ³	lb/ft ³	g/cm ³	lb/in ³
1	0,062 4	0,001 00	0,000 036 1
16,0	1	0,016 0	0,000 579
1 000	62,4	1	0,036 1
27 680	1 728	27,7	1

Force, F

N newton	lbf pound-force	kp kilopond
1	0,225	0,102
4,45	1	0,454
9,81	2,20	1

Torque, M

lbf · in	Nm	lbf · ft	kpm
1	0,113	0,083 3	0,011 5

The SI system

lbf · in	Nm	lbf · ft	kpm
8,85	1	0,738	0,102
12,0	1,36	1	0,138
86,8	9,81	7,23	1

Energy, work, E

J joule Nm, Ws	Btu British thermal unit	kcal kilocalorie	kWh
1	0,000 948	0,000 239	0,000 000 278
1 055	1	0,252	0,000 293
4 187	3,97	1	0,001 16
3 600 000	3 412	860	1

Power, P

Btu/h	W watt Nm/s, J/s	kcal/h	hk metric horsepower	hp UK, US horsepower
1	0,293	0,252	0,000 398	0,000 393
3,41	1	0,860	0,001 36	0,001 34
3,97	1,16	1	0,001 58	0,001 56
2 510	735	632	1	0,986
2 544	746	641	1,01	1

Temperature difference, temperature change, ΔT for K; $\Delta\theta$ for °C

K kelvin	°F degree Fahrenheit	°C degree Celsius
1	1,80	1,00
0,556	1	0,556
1,00	1,80	1

Associated temperatures

K	°F	°C	Physical state
0,00	-460	-273	Absolute zero
255	0,00	-17,8	Mixture of sal ammoniac and snow
273	32,0	0,00	Melting point of ice
293	68,0	20,0	Standard atmospheric temperature
311	100	37,8	Normal temperature of human body
373	212	100	Boiling point of water

Conversion between temperatures

$$^{\circ}\text{C} = (^{\circ}\text{F} - 32) \times 5/9 \quad ^{\circ}\text{C} = \text{K} - 273,15$$

$$^{\circ}\text{F} = ^{\circ}\text{C} \times 9/5 + 32 \quad \text{K} = ^{\circ}\text{C} + 273,15$$

Greek letters

Greek letters are used in technical and scientific texts to denote physical units. Minor variations in the shapes of the letters can be tolerated, on condition that this does not cause any risk of confusion.

The SI system

Name	Lower case	Upper case
alfa	α	A
beta	β	B
gamma	γ	Γ
delta	δ	Δ
epsilon	ϵ	E
zeta	ζ	Z
eta	η	H
teta	ϑ	Θ
jota	ι	I
kappa	κ	K
lambda	λ	Λ
my	μ	M
ny	ν	N
ksi	ξ	Ξ
omikron	\omicron	O
pi	π	Π
ro	ρ	P
sigma	σ	Σ
tau	τ	T
ypsilon	υ	Y
fi	φ	Φ
ki	χ	X
psi	ψ	Ψ
omega	ω	Ω

Pressure

Total pressure = dynamic pressure + static pressure

The static pressure in the atmosphere varies with the weather - high pressure or low pressure - and with the height above sea level. The standard pressure, atmospheric pressure at sea level is:

101,3 kPa = 1,013 bar = 1013 mbar

(= 1 atm = 760 mm Hg)

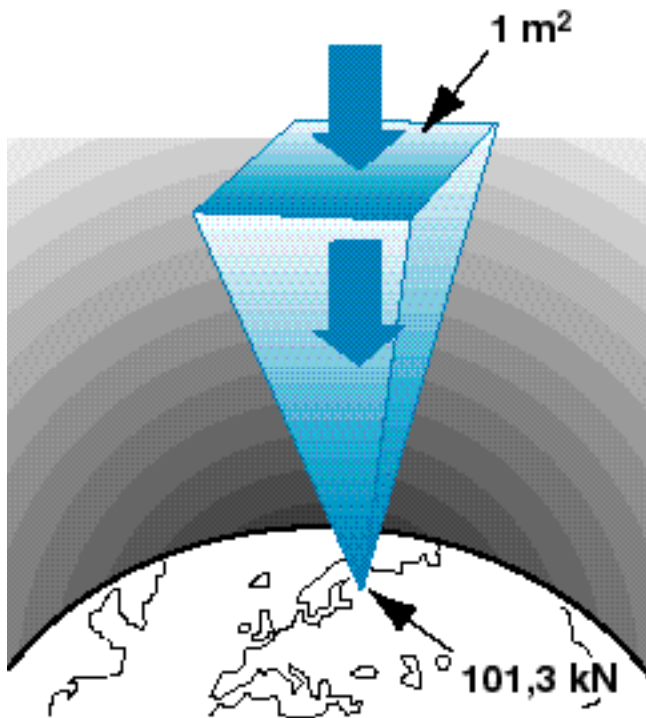

At one particular point, such as in a ventilation duct, the static pressure comes from all sides.

In a ventilation system, the static pressure is related to the ambient atmospheric pressure outside the duct system; the static pressure can thus be positive - higher than ambient atmospheric, or negative - lower than ambient atmospheric pressure.

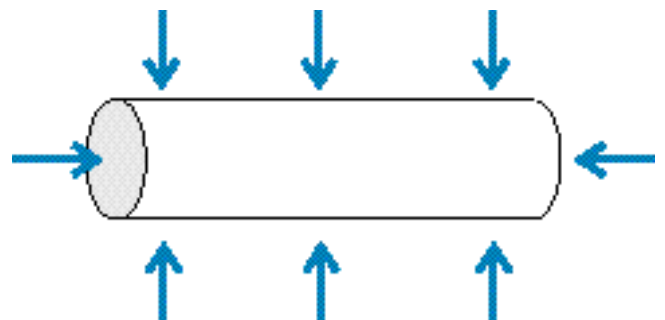
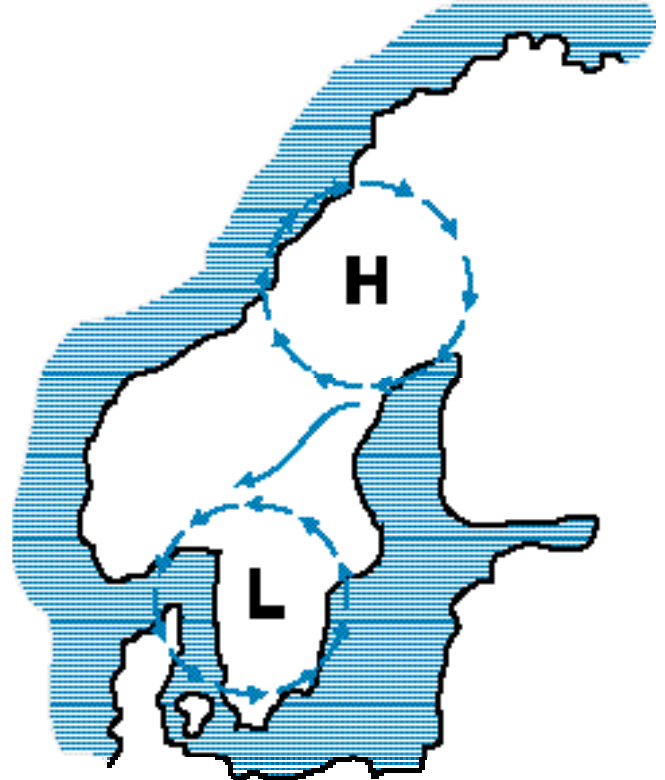

Pressure

Pressure drop

If you produce a static pressure difference in an open duct system, you can get the air to flow from a point of higher pressure to a point of lower pressure - from the atmosphere via the inlet grating to the suction side of the fan, and from the supply side of the fan via the supply terminals back to the atmosphere. The pressure difference is converted into kinetic energy.

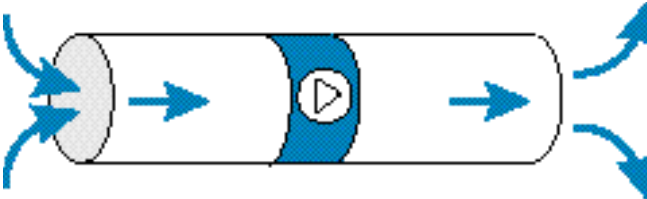

Dynamic pressure is a measure of the kinetic energy of the moving air. The connection between pressure and energy is easy to see if you use SI system units

$\text{Pa} = \text{N/m}^2 = \text{Nm/m}^3 = \text{J/m}^3$ i.e. energy (in J) per unit volume (in m^3) of the flowing air.

The dynamic pressure depends on

$$P_d = \rho \cdot \frac{\bar{v}^2}{2} \text{ with the units}$$

$$\frac{\text{kg}}{\text{m}^3} \cdot \left(\frac{\text{m}}{\text{s}}\right)^2 = \frac{\text{kg}}{\text{m}^3} \cdot \frac{\text{m}^2}{\text{s}^2} = \frac{\text{kgm}}{\text{s}^2} \cdot \frac{\text{m}}{\text{m}^3} = \text{N} \cdot \frac{1}{\text{m}^2} = \frac{\text{N}}{\text{m}^2} = \text{Pa}$$

Flow in a duct system is normally not free of loss. Friction losses occur and the air is forced to change direction. It requires pressure (i.e. energy) to manage both dynamic and static pressure - the sum of these two is referred to as total pressure.

$$P_t = P_s + P_d$$

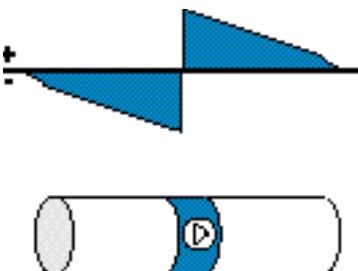

Since p_s will be negative in relation to atmospheric pressure (on the suction side of the fan), this means that p_t will also be negative if the total of p_s and p_d is negative.

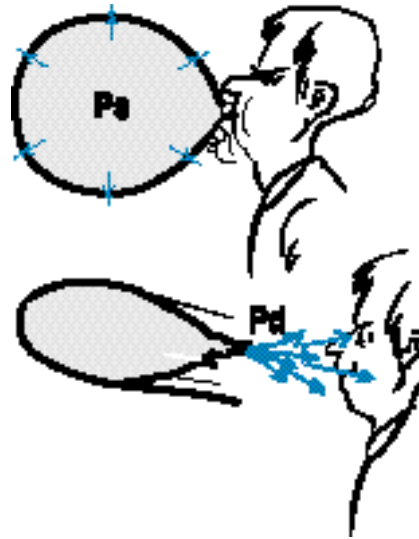

Pressure drop and flow losses

In a ventilation system, you want to get air moving! Clean air is to be supplied to the occupancy zone and polluted air must leave the room, process or machine. Energy is needed to move the air, which is added via the fan, which gets the air moving.

In order to flow through a duct system, air has to overcome two types of flow resistances or pressure drops:

- **friction loss** between the flowing air and the duct walls.
- **single loss** when the air changes direction or speed.

Friction loss (also known as the R value) is expressed in the unit Pa/m

$$\Delta p_f = \frac{\lambda}{d_h} \cdot \rho \cdot \frac{\bar{v}^2}{2}$$

where

Δp_f = friction loss per metre (Pa/m).

λ = friction factor related to duct material and surface roughness.

d_h = hydraulic diameter of the duct, the diameter of a circular duct which gives the same friction pressure drop at the same flow velocity as a rectangular duct.

$$d_h = \frac{2 \cdot a \cdot b}{a + b}$$

where a and b are duct sides.

For a circular duct, $d_h = d$

ρ = air density (kg/m^3)

\bar{v} = average velocity of the air (m/s)

Pressure

Pressure drop calculation

Fan pressure capacity required

Let us do a pressure drop calculation for a simple duct system!

-
-
-

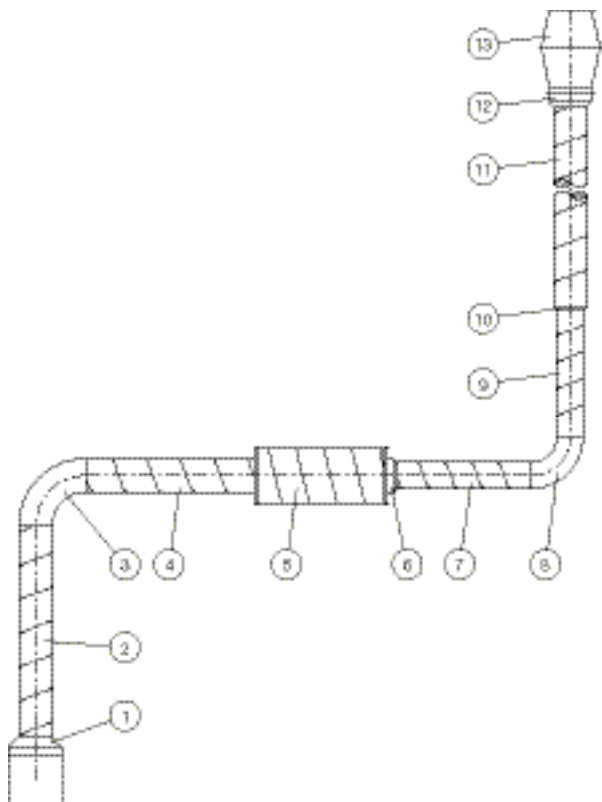

No	Flow l/s	Component Denom.	Dimension Ø mm	Length m	Pressure drop Pa/m	Pressure drop Pa
①	400	RCU	315-250	-	-	8,2
②	"	SR	250	2,0	3,3	6,6
③	"	BU 90°	250	-	-	11,0
④	"	SR	250	1,6	3,3	5,3
⑤	"	SLU 100	250/1200	1,2	5,0	6,0
⑥	"	RCFU	250-200	-	-	22,0
⑦	"	SR	200	1,5	8,0	12,0
⑧	"	BU 90°	200	-	-	24,0
⑨	"	SR	200	1,2	8,0	9,6
⑩	"	RCU	250-200	-	-	15,0
⑪	"	SR	250	3,5	3,3	11,6
⑫	"	RCFU	400-250	-	-	16,0
⑬	"	HF	400	-	-	14,0
<i>Total pressure drop (sum of rows 1 – 13) = 161,3</i>						

Add up the pressure drops on the far right of the table.

Then select a suitable fan which gives the required flow $q = 400$ l/s and a total pressure rise of $p_{t} = 161$ Pa.

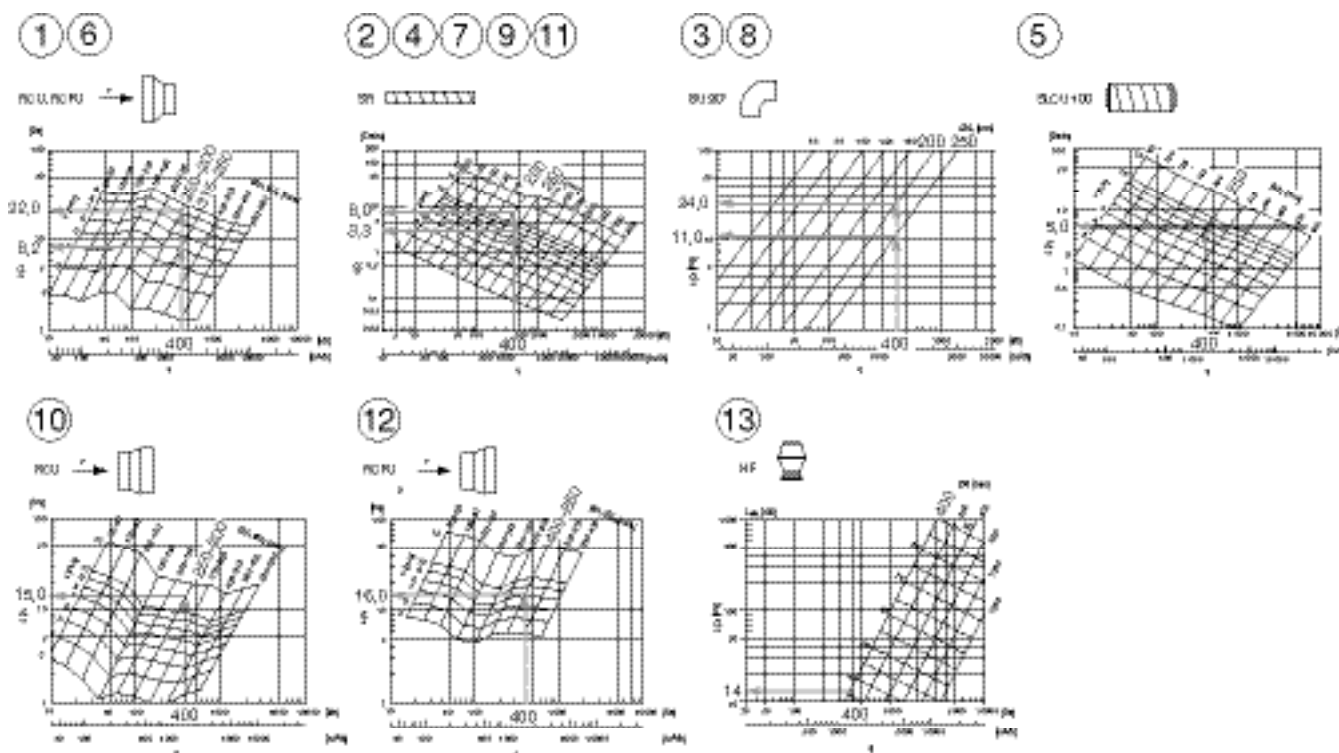

Pressure

Prerequisites

In order to correctly dimension a duct system you need information about the total pressure drops of the fittings.

The total pressure drop Δp_t (Pa) between two sections, 1 and 2, in a duct system is defined by

$$P_t = P_{t1} - P_{t2} = (P_{s1} + P_{d1}) - (P_{s2} + P_{d2})$$

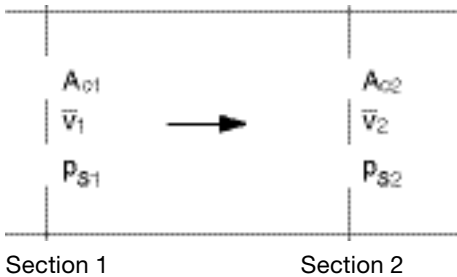

where $p_d = \frac{\rho \cdot \bar{v}^2}{2}$ and $\bar{v}^2 = \frac{q}{a_c}$

It is assumed in pressure drop calculation of ventilation ducts that:

- incompressible flow, i.e. air density does not change.
- isothermal relationship, i.e. no exchange of heat between the duct and its surroundings occurs.
- no changes in potential energy, i.e. height differences between the various sections of the duct system are neglected.

Designations used

l	= length	m (mm)
a	= long side	m (mm)
b	= short side	m (mm)
r	= radius	m (mm)
d	= diameter	m (mm)
d _h	= hydraulic diameter	m (mm)
A _c	= cross sectional area	m ²
p _A	= atmospheric pressure	mbar
p _s	= static pressure	Pa
p _d	= dynamic pressure	Pa
p _t	= total pressure	Pa
Δp	= pressure drop	Pa
Δp _t	= total pressure drop	Pa
θ	= temperature	°C
\bar{v}	= air velocity (average)	m/s
q	= air flow	m ³ /s
ρ	= density	kg/m ³
α	= angle	°
φ	= relative humidity	%
λ	= friction number	
R	= coefficient of friction	Pa/m
ζ	= resistance number	
v	= kinematic viscosity	m ² /s

The total pressure drops for the most common fittings are shown in graphs, as a function of air flow (or velocity in some cases).

The basic data for the graphs comes from measurements and calculations done at our laboratories. Some graphs are taken from literature.

The graphs apply to air under standard conditions.

v	= 15,1 · 10 ⁻⁶ m ² /s
θ	= 20 °C
ρ	= 1,2 kg/m ³
φ	= 65 %
p _A	= 1013,2 mbar

For air of other density (ρ_{other}) the flow (q_{other_density}) is obtained from the formula.

$$q_{\text{other_density}} = q_{\text{graph}} \cdot \sqrt{\frac{1,2}{\rho_{\text{other}}}}$$

Sound

About silencers

The Lindab silencers are of the absorption silencer type. The damping ability of absorption silencers is affected by the geometric design of the silencer and the type of damping material chosen. Silencer comprises several such variants, with different properties. The graph below summarises the attenuation of some types of silencers.

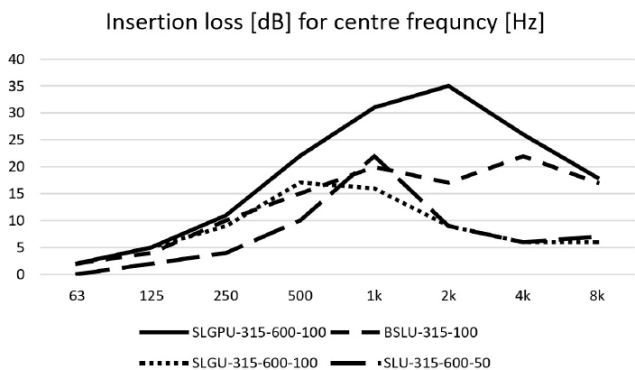

Attenuation material and cleaning of the silencers

Lindab uses different attenuation materials depending on the needed property of attenuation and cleanability.

Mineral wools: stone or glass wool are always covered by a surface textile to prevent the fibres from coming out of the acoustic media. All the silencers can be cleaned with a rotating nylon brush or a vacuum cleaner.

The silencers made from Lindtec wool or Acutec® polyester attenuation material can also be cleaned with a damp cloth. In the case that mechanical cleaning is needed it is also possible to cover the attenuation material with perforated plate.

Most of the silencers with a round connection are made with perforated plate or stretch metal mesh to protect the attenuation material.

Method of measurement

The silencers are tested in accordance with ISO 7235 "Acoustics - Measurement procedures for ducted silencers - Insertion loss, flow noise and total pressure loss".

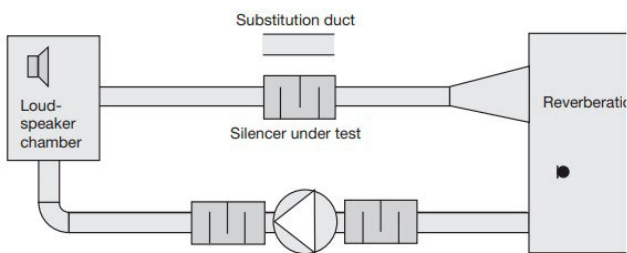

Sound

Ventilation does not have to be noisy!

If you use your common sense, and construct your air treatment system with consideration and good components, you can often avoid problems and complaints.

Fans make noise, this is something you can not do a lot about. But you can prevent the noise from getting into the areas connected to the fan system - you can absorb and damp the noise on the way.

This description does not claim to teach you how to calculate and attenuate noise in a ventilation system - there are books available on this.

Source

Waves on water

We throw a stone onto completely calm water.

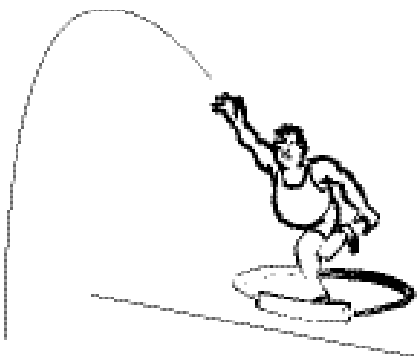

Waves in air

We fire a starter's gun.



This description only aims at providing information about a few simple rules and hints, which together with common sense can be enough for simple installations.

You must have some basic knowledge about how and where noise is generated, transmitted and attenuated in the system, to be able to choose the correct principle and correct components. To take a simple analogy: noise transmission consists of waves in a medium, i.e. air, which we can not see. This is very similar to the way waves spread on water.

Let us examine the analogy, to make the comparison clearer:

Distribution

Waves on water

Waves on water spread out in increasing concentric circles from the centre, where the stone hit the water.



Waves in air

Sound waves spread out in the air, in all directions, in an increasing ball from the centre, i.e. the gun.



Sound

Energy transport

Waves on water

Kinetic energy is transmitted from molecule to molecule in the water. They bounce against each other. Molecules move back and forwards. Energy spreads from the source.

Waves in air

Kinetic energy is transmitted from molecule to molecule in the air. They bounce against each other, and move back and forwards. Energy spreads from the source.

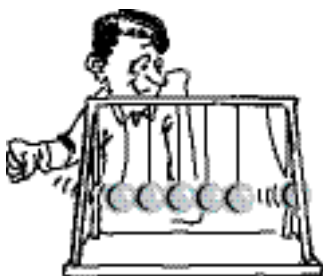

Distance

Waves on water

When waves depart from the centre, where the stone hit, the wave height becomes lower and lower, until they are invisible. The water is calm again.

Waves in air

When sound waves depart from the source, the starter's gun, wave movement drops off and the sound becomes weaker and weaker until it can no longer be heard.



Intensity

Waves on water

The energy which started the wave propagation, or the power needed to keep it going, is distributed across an increasing area as the distance, the radius, increases.

Waves in air

The energy which started the wave propagation, or the power needed to keep it going, is distributed across an increasing volume as the distance, the radius, increases.



Obstruction in the way

Waves on water

If waves in water encounter the side of a boat or jetty, they will be reflected at the same angle as they met the obstruction.

Waves in air

If waves in air encounter a wall, they will be reflected at the same angle as they met the obstruction.

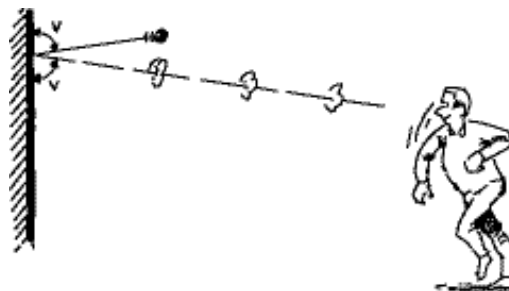

In the same way as when you bounce a ball on the wall.

Energy loss

Waves on water

The reflected wave height is lower than the incident wave. Some of the kinetic energy is absorbed in the collision with the jetty side (and is converted into heat).

Waves in air

The reflected wave movement is lower than the incident wave. Some of the kinetic energy is absorbed in the collision with the wall (and is converted into heat).



The ball moves more slowly when it bounces back than when it hits the wall.

Sound

Sound can be absorbed

When sound waves meet a soft, porous wall (mineral wool etc.), the vibrating molecules penetrate the surface layer, and are then braked by friction against the material fibres.

The part of the energy which is thus absorbed is converted to heat in the material, and the rest is reflected back into the room. This type of damping, where the sound is braked by the soft surface layer, is referred to as porous absorption.

The sound absorption ability of different materials varies. This property is expressed as the sound absorption factor α of the material.

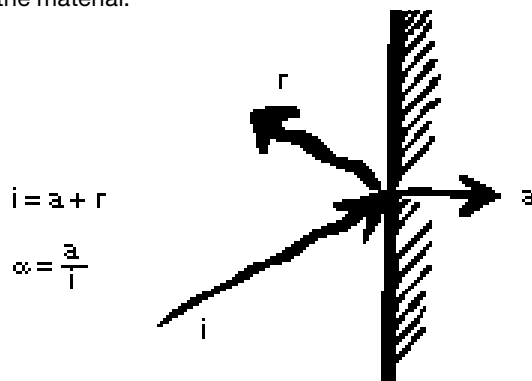

If nothing is absorbed, everything is reflected, then $a = 0$ which makes $\alpha = 0$:

$$i = 0 + r\alpha = \frac{0}{i} = 0$$

If nothing is reflected, everything is absorbed, then $r = 0$ which makes $\alpha = 1$:

$$i = a + 0\alpha = \frac{a}{a} = 1$$

An open window can be said to have $\alpha = 1$, all sound from the room which arrives at the window disappears out!

In hard materials, such as concrete or marble surfaces, virtually no sound energy is absorbed, everything is reflected and the α value is near to zero. In rooms with hard surfaces, the sound bounces for a long time before it dies out. The room has a long reverberation time and we get a strong, unpleasant echo. The sound level caused by normal sound sources becomes high.

In soft materials, such as thick mineral wool boards, the opposite happens. The α value is close to 1. Sometimes, excessively damped, soft rooms are unsuitable "You can't hear what you say". Avoid extremes - the reverberation time in a room should be chosen to suit the activities there.

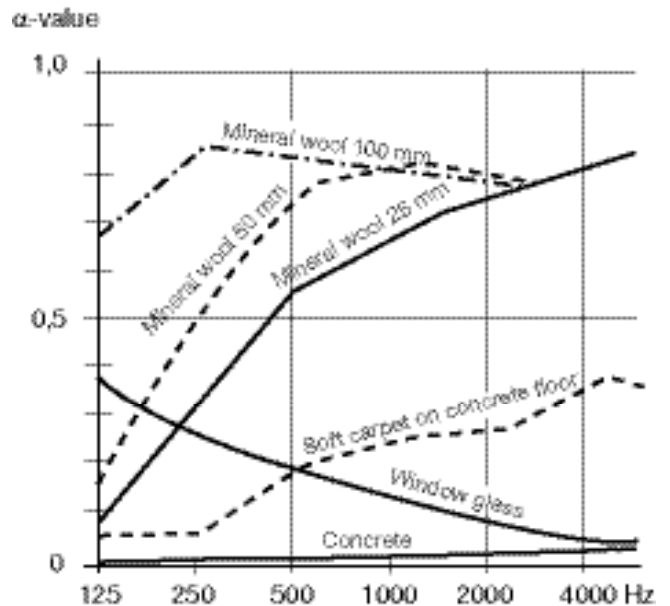

Sound, in a ventilation system, moves just as easily with or against the direction of flow.

Sound which moves through a duct system will be damped in several ways. Let us start off with bare metal duct walls.

Metal walls also absorb - but not much

When the metal duct walls are hit by the sound wave, they will start to vibrate at the same frequency as the sound.

The movements are normally very small, and hardly visible to the naked eye (it is often easier to feel the vibration, with your fingertips on the sheet metal).

What happens is the same as when a window vibrates when a heavy truck passes by on the street.

The duct panels and the window will then function as **membrane dampers** – boards which are made to vibrate by the incident sound energy. But this movement is not without friction, since it is braked by both the bending strength of the sheet, and (mostly) by the connection around the edges of the sheet. As previously, with the porous damper, some of the energy is converted into heat - the sound which remains has become weaker and has been damped.

Given the same free duct area, a circular, spiral seamed duct is stiffer than a rectangular one and will thus provide less damping.

As shown in the illustration on the next page, damping in un-lined ducts is relatively modest. For this reason, it is normally ignored when the noise in the installation is calculated, it is instead used as the margin of safety.

Attenuation in straight sheet metal ducts (1 mm sheet metal thickness)

Sound

Attenuation in straight sheet metal ducts (1 mm sheet metal thickness)

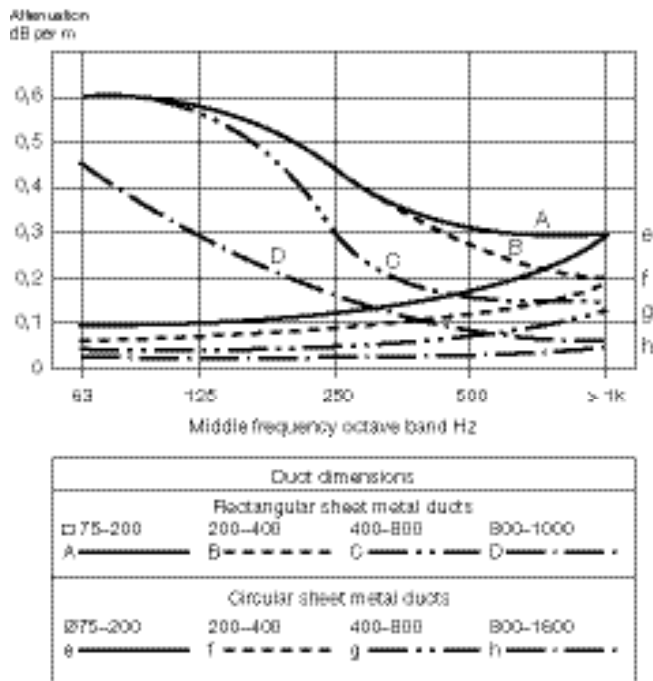

Absorption is more effective

The damping becomes more effective if we put absorbent material into the duct system. The way that sound is damped was described above, part of the sound energy is absorbed by the absorption material which is hit by the sound.

If the sound waves bounce enough times against porous surfaces, the remaining sound energy, the kinetic energy which makes your eardrums vibrate, will be so low that it does not cause annoyance!

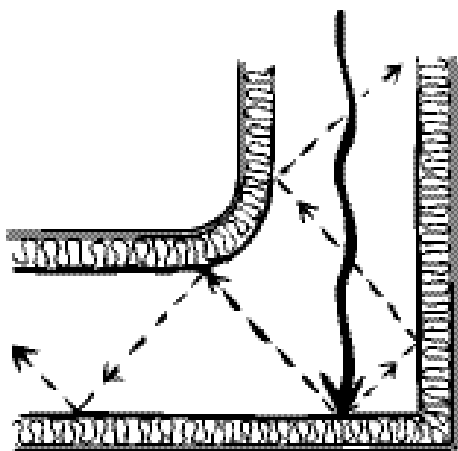

Where should you put the absorption material in the ducts?

The answer is obvious - where the material comes into contact with the greatest number of sound waves. Noise which travels along a long, unlined, straight duct will be directed by reflection against the duct walls. Absorption material here is of less use than if it is put in a bend, a suction or pressure plenum chamber or in a straight duct just after a fan, or anywhere where we have "turbulent sound flow". The more times sound bounces against the soft sides, the more useful the material becomes.



Why the curved silencer BSLU is so effective!

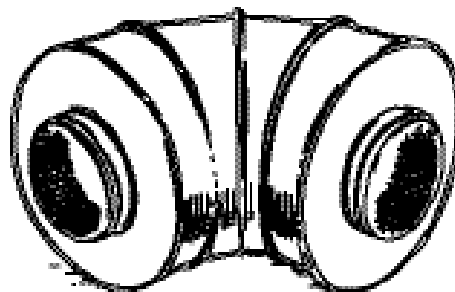

Straight silencers concentrate the absorption material

There is a complement to the description of sound waves above. When the sound waves travel along a porous surface, they will be deflected towards the duct walls. This deflection is called, "diffraction".

This, and the way that sound propagation is disturbed by turbulence, gives that straight silencers can have high attenuation.

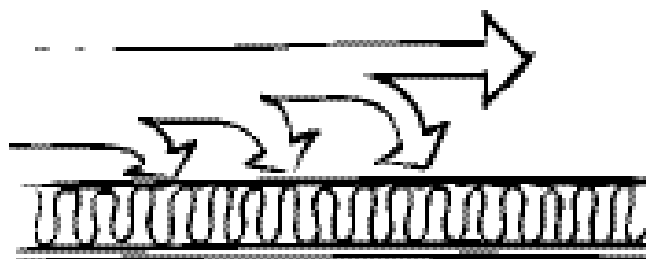

Sound

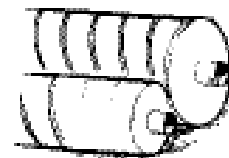

As we can see from the values for SLU 50 and SLU 100, damping varies with a few simple rules:

To attenuate low frequencies (< 500 Hz) thicker absorption material is needed. SLU 100 is more efficient than SLU 50.

SLU 50

Ød ₁ nom	l mm	Insertion loss [dB] for centre frequency [Hz]							
		63	125	250	500	1k	2k	4k	8k
315	600	0	2	4	10	22	9	6	7
315	900	2	3	7	16	31	13	8	9
315	1200	2	3	8	20	39	16	9	10

SLU 100

Ød ₁ nom	l mm	Insertion loss [dB] for centre frequency [Hz]							
		63	125	250	500	1k	2k	4k	8k
315	600	2	5	9	14	12	6	4	5
315	900	3	6	13	20	19	10	6	7
315	1200	4	8	16	27	25	15	9	10

To attenuate high frequencies (> 500 Hz), thinner absorption material is sufficient. SLU 50 is just as effective as SLU 100.

SLU 50

Ød ₁ nom	l mm	Insertion loss [dB] for centre frequency [Hz]							
		63	125	250	500	1k	2k	4k	8k
315	600	0	2	4	10	22	9	6	7
315	900	2	3	7	16	31	13	8	9
315	1200	2	3	8	20	39	16	9	10

SLU 100

Ød ₁ nom	l mm	Insertion loss [dB] for centre frequency [Hz]							
		63	125	250	500	1k	2k	4k	8k
315	600	2	5	9	14	12	6	4	5
315	900	3	6	13	20	19	10	6	7
315	1200	4	8	16	27	25	15	9	10

The longer way the sound has to pass over the absorption surface the higher the attenuation. Long silencers have higher attenuation than short ones. SLU with l = 600 attenuates more than SLU with l = 300.

SLU 50

Ød ₁ nom	l mm	Insertion loss [dB] for centre frequency [Hz]							
		63	125	250	500	1k	2k	4k	8k
315	600	0	2	4	10	22	9	6	7
315	900	2	3	7	16	31	13	8	9
315	1200	2	3	8	20	39	16	9	10

NOTE!

The attenuation is not directly proportional to the length. The reason for this is that you get an extra attenuation at cross section area changes, and all silencers have two of them irrespective of their length.

The shorter distance between the absorbing surfaces the higher the attenuation. Silencers with small diameter attenuates more than big ones. SLU Ø 200 attenuates more than SLU Ø 315.

SLU 50

Ød ₁ nom	l mm	Insertion loss [dB] for centre frequency [Hz]							
		63	125	250	500	1k	2k	4k	8k
200	600	1	3	8	15	28	19	12	8
200	900	2	4	11	21	37	28	16	10
200	1200	2	5	14	27	46	36	21	13
315	600	0	2	4	10	22	9	6	7
315	900	2	3	7	16	31	13	8	9
315	1200	2	3	8	20	39	16	9	10

For the same reason, an extra pod gives higher attenuation than a silencer of the same diameter, but without a pod. SLGPU 100 attenuates more than SLU 100.

SLU 100

Ød ₁ nom	l mm	Insertion loss [dB] for centre frequency [Hz]							
		63	125	250	500	1k	2k	4k	8k
315	600	2	5	9	14	12	6	4	5
315	900	3	6	13	20	19	10	6	7
315	1200	4	8	16	27	25	15	9	10

SLGPU 100

Ød ₁ nom	l mm	Insertion loss [dB] for centre frequency [Hz]							
		63	125	250	500	1k	2k	4k	8k
315	600	2	5	11	22	31	35	26	18
315	900	3	7	15	29	40	44	34	23
315	1200	3	8	19	36	46	50	39	26

Noise frequency influences the choice of silencer

As we see in the tables above, the damping ability varies with the frequency of sound. Before we look at the choice of silencers, it could be a good idea to describe the concept of frequency in greater detail.

A sound source influences the surrounding air, and makes it vibrate. The character of the sound depends on the variations in pressure which occur in the air.

Let us assume that the sound source is a vibrating plate - the changes in pressure, or the sound will then have the same frequency as the vibrations in the plate. The strength of the sound will depend on the amount that the plate vibrates, i.e. the amplitude of the movement. Let us start off with that:

If there is only one note, of a single frequency, the pressure will vary sinusoidally, so a pure note is referred to as a sine wave.

Sound

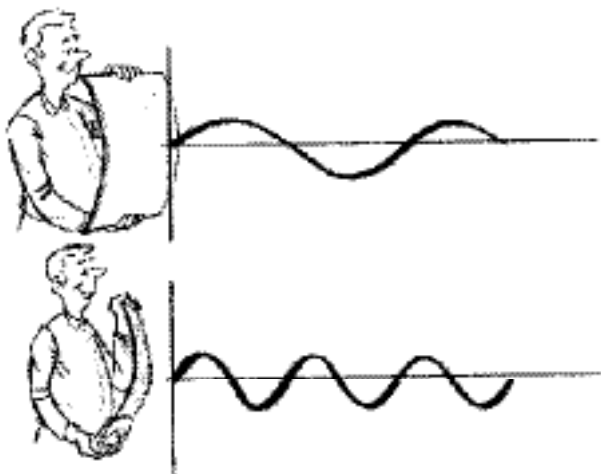

The characteristics of sound propagation are:

- frequency (f),
which is measured in hertz, **Hz**, (s^{-1}), (and specifies the number of times a second that a new sound wave arrives).
- wave length (λ , "lambda"),
which is measured in metres, **m**, (and specifies the distance between two similar points on the curve).

and

- speed of sound (c)
which is measured in **m/s**, (and specifies the speed of movement of the sound wave).

These three variables have the following relationship:

$$c = f \cdot \lambda$$

The speed of sound in air is also a function of pressure and temperature.

At normal air pressure and + 20 °C is $c \approx 340$ m/s.

A young person with normal hearing can hear sounds at frequencies from 20-20 000 Hz, i.e. (in air) at wavelengths ranging from 17 m (at 20 Hz) to app. 17 mm (at 20 kHz).

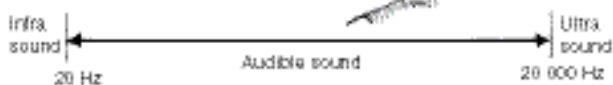

We perceive changes in sound frequency on a logarithmic scale, i.e. it is the relative frequency and not the difference in Hz which determines how a change in note is perceived. A doubling of frequency is perceived as being the same, irrespective of whether it is a change from 100 to 200 Hz, 1000 to 2000 Hz or 10 to 20 kHz.

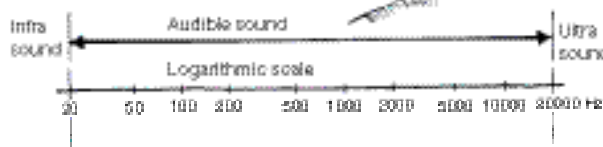

The logarithmic scale is usually sub-divided into octaves, i.e. in scales where the top note is twice the frequency of the bottom note. This has been customary in music for a long time.

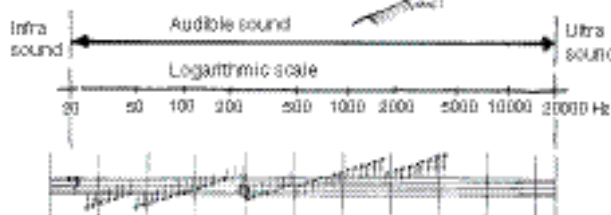

And in engineering.

Sound

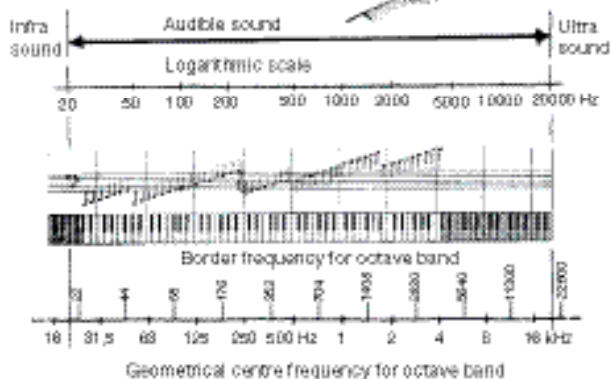

The concept of decibel

The stronger the sound is, the harder the particles of air will bump into each other.

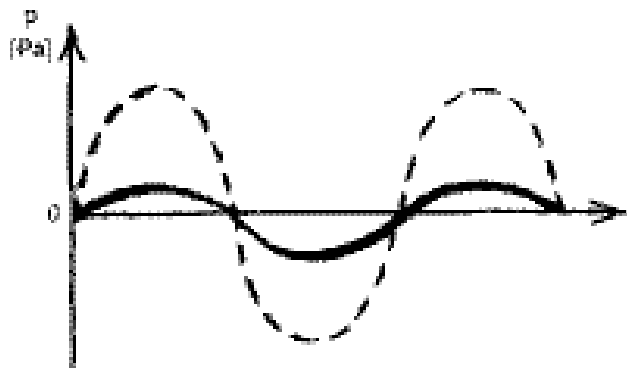

Sound pressure changes in the audible area can vary within very wide limits. Some sounds are so weak that we can not hear them. The so-called **audible limit** varies with frequency and is 20 mPa at about 1000 Hz .

Other sounds are so loud that we risk hearing damage. The **pain limit**, the sound pressure which causes pain in your ears also varies with frequency, but is about 20 Pa at 1000 Hz. This means that it is a million times louder than the weakest sound we can perceive.

We also perceive changes in sound pressure on a logarithmic scale. A **sound level concept** using the **decibel (dB)** as the unit, has been created to express comparable values.

The **dB** unit, which is used in many different applications,

is generally defined as: $10 \cdot \log (X/X_0)$, where X is the unit measured, i.e. the sound pressure, and X_0 is a reference level expressed in the same units. The relationship of X/X_0 is thus dimensionless. The reference level from which the dB unit is specified, is given instead. This means that you generally express the level in **dB (above X_0)**.

Our perception of sound

We react differently to two sounds which have the same sound pressure level and different frequencies.



Curves which describe how people normally perceive sounds of varying strength and frequency have been constructed through experiments on large numbers of volunteers. These so-called **hearing level curves** are designated by the sound pressure level for each curve at a frequency of 1 kHz. The unit used for the curves is the **phon**.

Hearing level curves

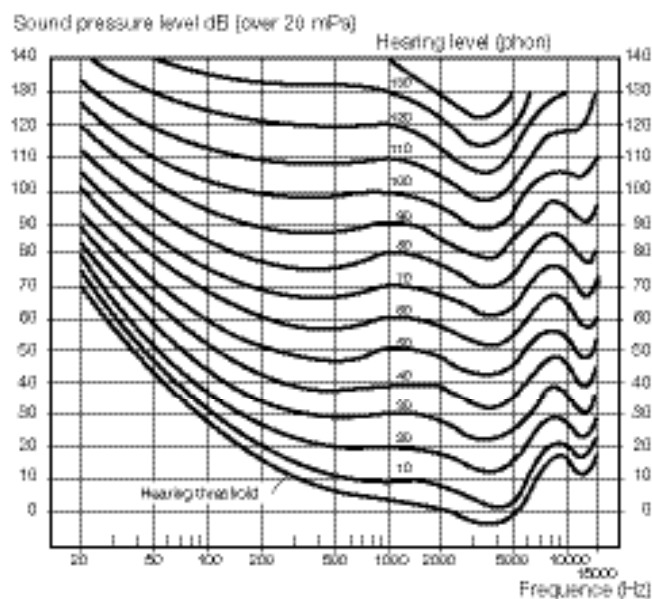

Example:

The sound pressure level 70 dB at 50 Hz is normally perceived as being as loud as 50 dB at 1000 Hz.

Sound

Sound levels

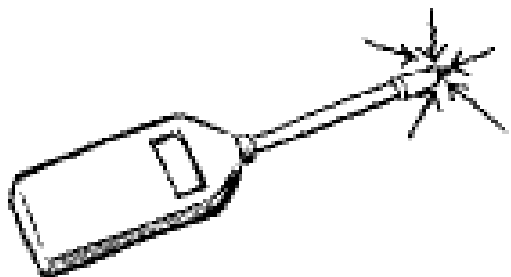

Several methods are used to compare the disturbance caused by two different sounds, and where the perception of the ear to noise has been modelled.

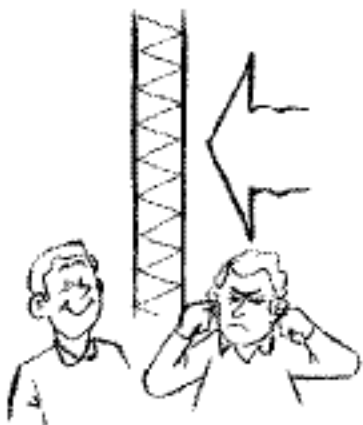

The simplest way is to compare their “weighted” sound levels. The incoming sound is filtered in an electronic filter to reduce the components, mostly the low-frequency components, where the ear is not so sensitive, and amplify the components between 1 and 4 kHz, where we are most sensitive.

Sound meters usually have three electronic filters, A-, B- and C-filter. The A-filter is mostly used these days, where the result, the “weighted” **sound level**, is expressed in **dB (A)**

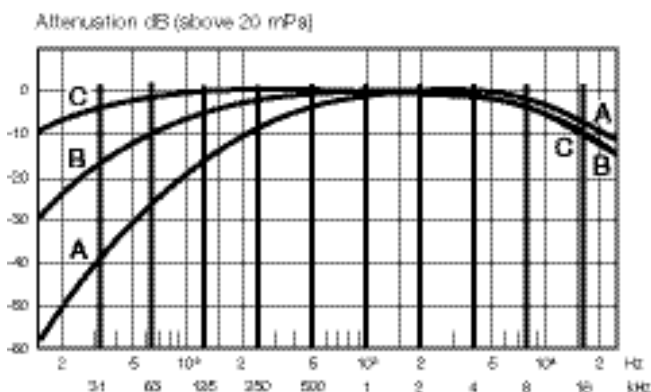

Choosing silencers

The fan is the primary sound source in a ventilation system, but intrusive noise can also be caused by an unsuitable choice of duct components and terminal units:

$$L_W = 40 + 10 \cdot \log q + 20 \cdot \log p_t \text{ dB (above 1 pW)}$$

q = air flow (in m³/s) through the fan

p_t = total pressure rise (in Pa) in the fan

40 = “specific noise power level” which considers the efficiency of the fan at its point of operation, and the SI units for q and p_t .

The noise generated in the fan must be attenuated in the duct system, at some point before the room terminal unit. Some of the attenuation is “natural”, examples are given above. This attenuation is often not enough, and additional silencers can be put in the duct system - in the main channel near the fan to damp the fan noise to all the duct branches or in the branch ducts only to damp particularly sensitive rooms.

Low air speeds should be selected in the ducts, to avoid disturbing noise in the rooms.

- At a given air speed, a doubling of that speed corresponds to a 12 dB increase in noise levels.

Low air speeds also cut operating costs.

- At a given air speed, the fan power required increases as the square of the air speed.

In this example, calculation has shown that the existing attenuation in the duct system is not enough. The table shows that more attenuation is needed. What to choose?

Example

Duct Ø315

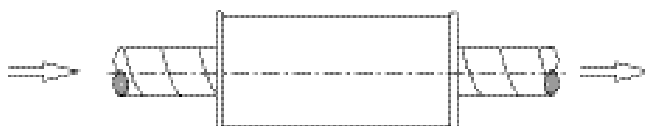

	63	125	250	500	1k	2k	4k	8k	
Before	X	X	X	X	X	X	X	X	dB
After	X	X	X	X	X	X	X	X	dB
Difference	2	4	9	19	21	12	7	7	dB

Lindab has a large range of silencers with varying characteristics and dimensions. Let's see what might fit!

Sound

SLU-50	63	125	250	500	1k	2k	4k	8k
Required	2	4	9	19	21	12	7	7
600	0	2	4	10	22	9	6	7
900	2	3	7	16	31	13	8	9
1200	2	3	8	20	39	16	9	10

This is the narrowest silencer, so the longest one, 1200 mm, should be selected to meet the requirements. The deviations at the 125 and 250 Hz band, 1 dB, are small and will not be noticeable. This is one of the possible alternatives

SLU-100	63	125	250	500	1k	2k	4k	8k
Required	2	4	9	19	21	12	7	7
600	2	5	9	14	12	6	4	5
900	3	6	13	20	19	10	6	7
1200	4	8	16	27	25	15	9	10

This silencer has a thicker layer of absorbing material (100 mm instead of 50 mm) and thus has better low frequency insertion loss, but also has a larger external diameter than SLU-50. To meet the requirements, you should choose the longer one, 900 mm. The deviations at the 1k - 8k frequencies are small and will not be noticeable. This is another of the possible alternatives.

SLGPU	63	125	250	500	1k	2k	4k	8k
Required	2	4	9	19	21	14	7	7
600	2	5	11	22	31	35	26	18
900	3	7	15	29	40	44	34	23
1200	3	8	19	36	46	50	39	26

This silencer has the same thickness of absorbing material as SLU 100 (100 mm) but also has a 100 mm thick baffle which increases damping (but also the pressure drop across the silencer). You only have to choose the shortest one, 600 mm, to meet the requirements at all frequencies by a wide margin. This is still another possible alternative.

The final choice of alternatives is determined by other considerations:

- **SLU-50 1200**

if there is space lengthways, (but perhaps tight at the sides).

- **SLU-100 900**

shorter, but needs more room at the sides.

- **SLGPU 600**

If the lengthways space is limited and if the slight increase in total pressure drop is not important - e.g. in a branch duct where part of the available pressure has to be restricted anyway when the air flows are adjusted.

Decide how safe the values in the sound calculation are, and choose a silencer with the corresponding margin of safety. It is always more expensive and more difficult to add attenuation afterwards, if it was not installed from the beginning. If the users ever become dissatisfied with the noise, it is difficult to get them to change their views.



Most of us spend the majority of our time indoors. Indoor climate is crucial to how we feel, how productive we are and if we stay healthy.

We at Lindab have therefore made it our most important objective to contribute to an indoor climate that improves people's lives. We do this by developing energy-efficient ventilation solutions and durable building products. We also aim to contribute to a better climate for our planet by working in a way that is sustainable for both people and the environment.

[Lindab | For a better climate](#)