



Lindab **Stainless Duct System**

Technical information

Innehåll

Stainless duct system	3
Products	3
The circular duct system	3
The rectangular duct system	3
Description	3
Methods of use	3
The raw material	3
Corrosivity classes according to ISO 12944-2 with environmental examples	4
Eurovent certification	4
Product Overview	5
Ducts	5
Bends	6
Cleaning bends	14
Reducers	15
T-pieces	23
X-pieces	27
Take-offs	29
Couplings	32
End caps	34
Access doors	35
Dampers	37
UltraLink	39
Duct suspension and support system	40
Rectangular duct system	43
Fasteners	46
Other circular products	47

Stainless duct system

Products

The purpose of this brochure is to present which of Lindab's duct system products that are available in stainless steel. For more detailed information about the system and the products see our brochure "General information and theory" or each product's web page.

Products made of stainless steel are normally handmade instead of pressed and can therefore differ from the standard galvanized assortment in sizing and weight. Circular bends, 45° and 90°, in dimensions Ø100, Ø125 and Ø160 are exempted as they are pressed in both stainless and galvanized steel.

The circular duct system

The circular system is part of the Lindab Safe range of products and is manufactured as standard with a double seal gasket made of EPDM rubber. Standard dimensions adapted to EN 1506 are manufactured with a turned-over edge, which provides very good structural stability and increased durability against damage caused through handling.

For substances that cannot be tolerated by gaskets made of EPDM rubber – see the table about how various substances affect the gasket on Lindab's web page on air duct systems under the section "Safe" – gaskets made of silicon rubber can be used instead. If this additional option is not possible, fittings without gaskets can be manufactured.

The rectangular duct system

The rectangular system, which is part of the Lindab Rectangular range of products, consists of rectangular ducts and fittings with dimensions adapted to EN 1505 unless otherwise specified. The system is stable, homogeneous and torsional rigid thanks to reinforcement profiles and trapezoidal corrugated duct walls.

Description

Stainless steel does not readily corrode, rust or stain with water as ordinary steel does. However, it is not fully stain-proof in low-oxygen, high-salinity, or poor air-circulation environments. There are different grades and surface finishes of stainless steel to suit the environment the alloy must endure. Stainless steel is used where both the properties of steel and corrosion resistance are required.

Methods of use

Stainless steel is divided into two grades.

- The lowest grade is according to EN 1.4301 (AISI 304) and complies with the requirements for corrosivity class C4. EN 1.4301, which is the most common grade of stainless steel with a range of uses including kitchen equipment, domestic appliances, other purposes for indoor use and for slightly corrosive outdoor atmospheres, consists of approximately 9% nickel, 18% chromium and the rest steel.
- The higher grade is according to EN 1.4404 (AISI 316L) and complies with the requirements for corrosivity class C5-I and C5-M. EN 1.4404, which is recommended for use in coastal areas and in polluted city or industrial atmospheres, consists of approximately 11% nickel, 17% chromium, 2.7% molybdenum and the rest steel. It is through the amalgamation with molybdenum that the improved corrosion properties are obtained.

Despite the fact that a lot of energy is consumed in the production of stainless steel, these materials are worthwhile from an environmental and cost perspective. The reason for this is that a large proportion of scrap is retrieved for amalgamation, that in many cases surface treatment is not necessary and that the need for maintenance decreases as the service life of the constructions increases.

The raw material

Ducts and fittings are manufactured as standard from bright annealed (BA) stainless steel sheets according to EN 1.4301 (EN 1.4501, AISI 304) and EN 1.4404 (AISI 316L). These grades have a very bright and even surface with a finish that is aesthetically pleasing.

Stainless duct system

Corrosivity classes according to ISO 12944-2 with environmental examples

Corrosivity category	Corrosivity	Examples of typical environments (informative only)	
		Exterior	Interior
C1	Very low	-	Heated buildings with clean atmosphere, e.g. offices, shops, schools, hotels.
C2	Low	Atmospheres with low level of pollution: mostly rural areas.	Unheated buildings where condensation can occur, e.g. depots, sports halls.
C3	Medium	Urban and industrial atmospheres, moderate sulfur dioxide pollution; coastal areas with low salinity.	Production rooms with high humidity and some air pollution, e.g. food-processing plants, laundries, breweries, dairies.
C4	High	Industrial areas and coastal areas with moderate salinity.	Chemical plants, swimming pools, coastal ship and boatyards.
C5	Very high	Industrial areas with high humidity and aggressive atmosphere and coastal areas with high salinity.	Buildings or areas with almost permanent condensation and with high pollution.
CX	Extreme	Offshore areas with high salinity and industrial areas with extreme humidity and aggressive atmosphere and subtropical and tropical atmospheres.	Industrial areas with extreme humidity and aggressive atmosphere.

Eurovent certification

Lindab's circular duct system with rubber gasket connections Lindab Safe and Lindab Safe Click is certified to strength and leakage in tightness class D according to the Eurovent Certified Performance program for circular metallic ducts systems (DUCT-MC). Check ongoing validity of certificate:



www.eurovent-certification.com

The purpose of Eurovent third party Certification is to create a common set of criteria to all relevant features for the rating of products in this system and ensure the constancy of performance over time.

Through specification of products in Lindab's certified system, Lindab Safe and Lindab Safe Click, the engineer's tasks become easier, since there is no need to carry out detailed comparison and performance qualification testing. Consultants, specifiers and users can select products with the assurance that the catalogue data are accurate to a certain level.

Lindab products that are Eurovent certified have the Eurovent logotype in the footer of the technical documentation.

Note: Most Lindab Safe and Lindab Safe Click and the most commonly used product in a ventilation system are essentially better than class D, however some products are according to EN 15727 not class D as a single product. These products are stated in the documentation as Class C and can be used in D class systems to a limited extension.

Product Overview

Circular duct system

Ducts

SR, circular duct

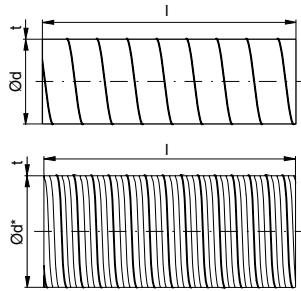

Ød nom	t mm	m kg/m	Comment
63	0,5	0,89	
80	0,5	1,01	
100	0,5	1,27	
112	0,5	1,42	
125	0,5	1,57	
140	0,5	1,76	
150	0,5	1,89	
160	0,5	2,02	
180	0,5	2,26	
200	0,5	2,56	
224	0,5	2,87	
250	0,5	3,18	
280	0,5	3,56	
300	0,5	3,82	
315	0,5	4,01	
355	0,5	4,51	
400	0,5	5,46	
450	0,6	7,37	
500	0,6	8,18	
560	0,6	9,20	
600	0,6	9,80	
630	0,6	10,3	
710	0,8	15,5	
800	0,8	17,4	
900	0,8	19,3	
1000	0,8	21,4	
1120	0,8	24,0	
1250	0,8	26,8	

For more detailed information about technical data and measures see datasheet for [SR](#)



Circular duct system

Bends

BU 90°, pressed bend

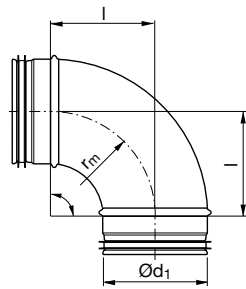

Ød, nom	Comment
100	For more detailed information about technical data and measures see datasheet for BU 90°
125	
160	

Are only available in EN 1.4404.

BU 45°, pressed bend

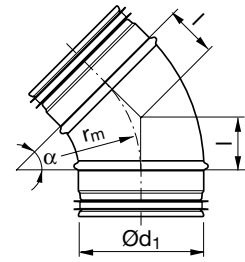

Ød, nom	Comment
100	For more detailed information about technical data and measures see datasheet for BU 45°
125	
160	

Are only available in EN 1.4404.

Circular duct system

Bends

BFU 90°, lockseamed bend

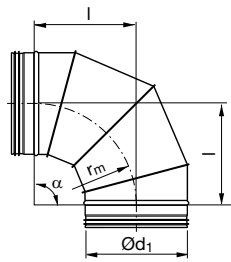

Technical data

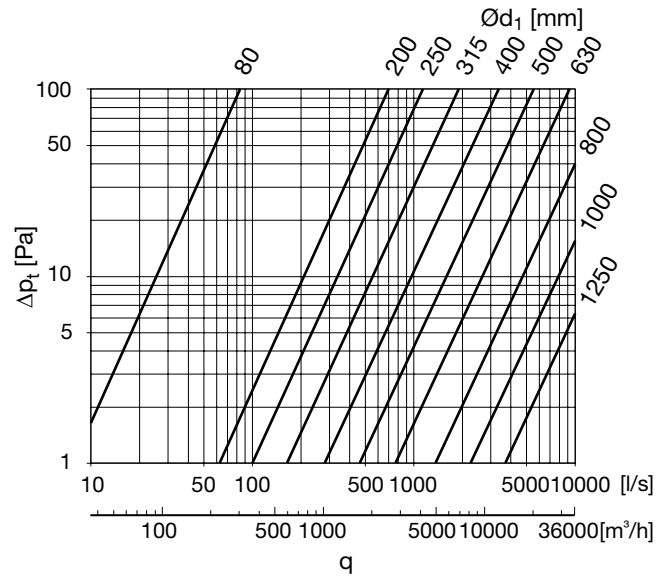

Ød, nom	l mm	m kg
80	80	0,25
140	140	0,61
150	150	0,84
180	180	1,02
200	200	1,30
224	224	1,33
250	•	•
280	•	•
300	•	•
315	•	•
355	•	•
400	•	•
450	•	•
500	•	•
560	•	•
600	•	•
630	•	•
710	•	•
800	•	•
900	•	•
1000	•	•
1120	•	•
1250	•	•

- For more detailed information about measures see datasheet for [BFU 90°](#)

Circular duct system

Bends

BFU 45°, lockseamed bend

Technical data

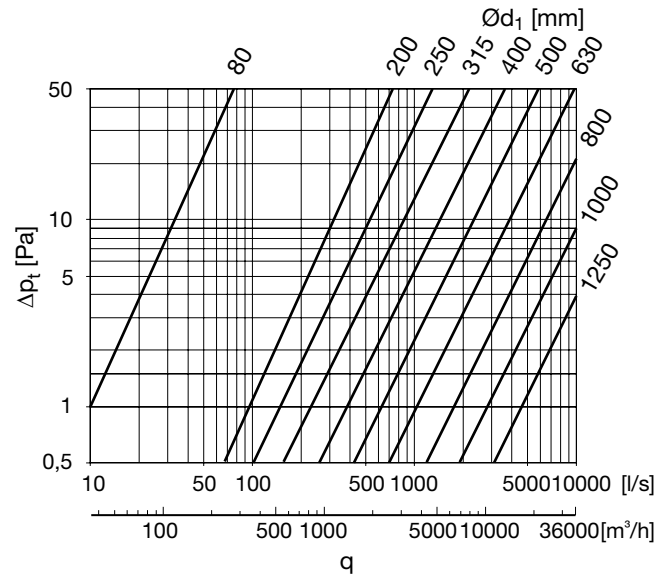
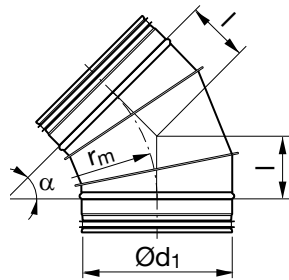

$O_{d, nom}$	l mm	m kg
80	33	0,17
140	58	0,42
150	62	0,47
180	75	0,64
200	83	0,80
224	93	0,82
250	•	•
280	•	•
300	•	•
315	•	•
355	•	•
400	•	•
450	•	•
500	•	•
560	•	•
600	•	•
630	•	•
710	•	•
800	•	•
900	•	•
1000	•	•
1120	•	•
1250	•	•

- For more detailed information about measures see datasheet for [BFU 45°](#)

Circular duct system

Bends

BFU 60°, lockseamed bend

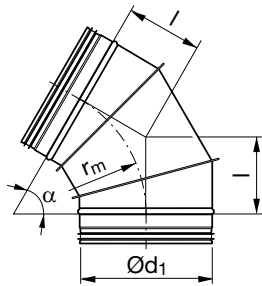

Technical data

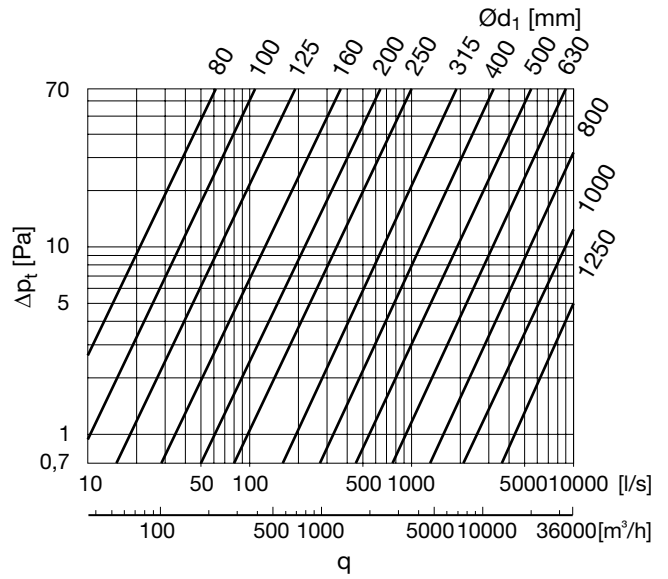

Ød, nom	l mm	m kg
80	46	0,24
100	58	0,33
125	72	0,40
140	81	0,50
150	87	0,58
160	104	0,65
180	92	0,79
200	115	0,95
224	129	0,99
250	•	•
280	•	•
300	•	•
315	•	•
355	•	•
400	•	•
450	•	•
500	•	•
560	•	•
600	•	•
630	•	•
710	•	•
800	•	•
900	•	•
1000	•	•
1120	•	•
1250	•	•

- For more detailed information about technical data and measures see datasheet for [BFU 60°](#)



Circular duct system

Bends

BFU 30°, lockseamed bend

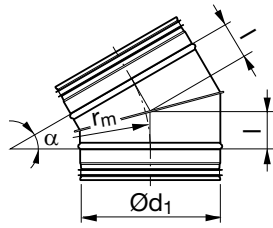

Ød ₁ nom	l mm	m kg
80	21	0,16
100	27	0,17
125	34	0,24
140	38	0,30
150	40	0,36
160	48	0,43
180	43	0,51
200	54	0,62
224	60	0,72
250	•	•
280	•	•
300	•	•
315	•	•
355	•	•
400	•	•
450	•	•
500	•	•
560	•	•
600	•	•
630	•	•
710	•	•
800	•	•
900	•	•
1000	•	•
1120	•	•
1250	•	•

Technical data

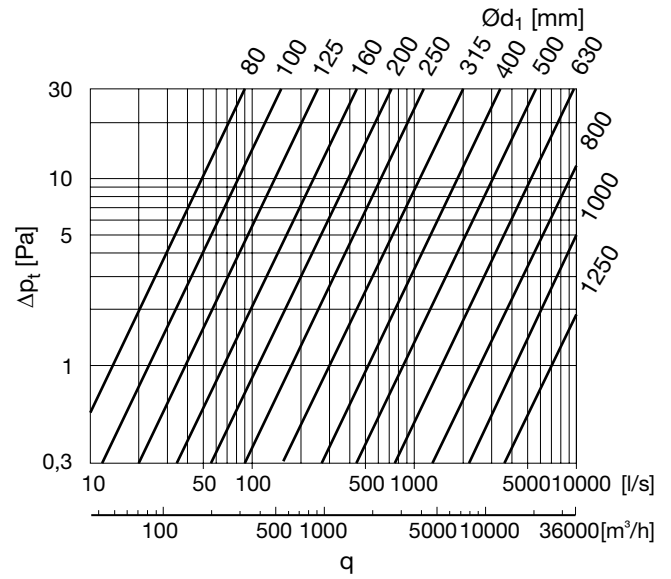

- For more detailed information about technical data and measures see datasheet for [BFU 30°](#)

Circular duct system

Bends

BFU 15°, lockseamed bend

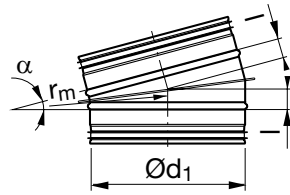

Technical data

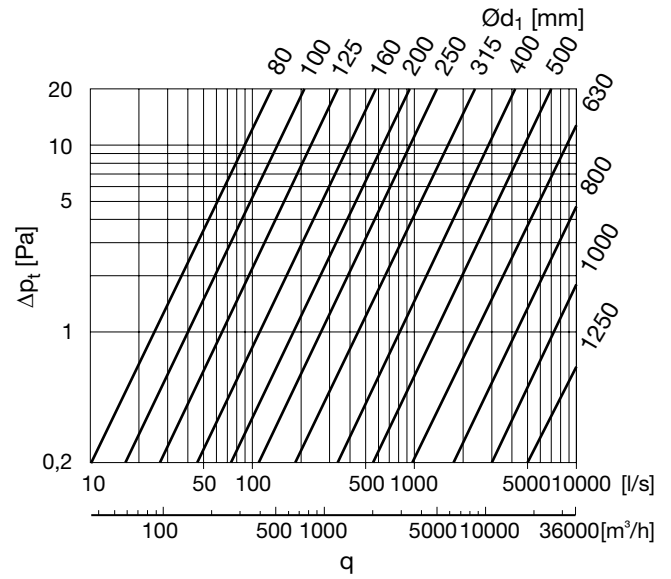

$\text{Ø}d$, nom	l mm	m kg
80	11	0,15
100	13	0,15
125	17	0,20
140	18	0,25
150	20	0,31
160	24	0,40
180	21	0,50
200	26	0,60
224	30	0,66
250	•	•
280	•	•
300	•	•
315	•	•
355	•	•
400	•	•
450	•	•
500	•	•
560	•	•
600	•	•
630	•	•
710	•	•
800	•	•
900	•	•
1000	•	•
1120	•	•
1250	•	•

- For more detailed information about technical data and measures see datasheet for [BFU 15°](#)



Circular duct system

Bends

BKU 90°, short bend

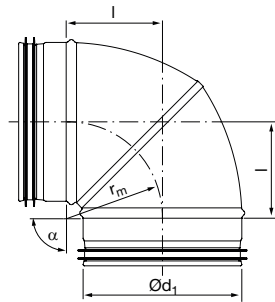

Ød, nom	l mm	m kg
80 *	55	0,14
100	62	0,24
125	79	0,36
160	94	0,53

* Elliptical design

- For more detailed information about technical data and measures see datasheet for [BKU 90°](#)

BKMU 90°, short bend with female end

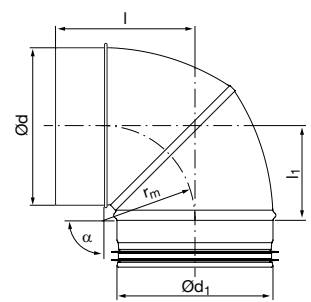

Ød, nom	l mm	l _i mm	m kg
80 *	97	55	0,13
100	105	65	0,25
125	120	79	0,48
160	137	94	0,86

* Elliptical design

- For more detailed information about technical data and measures see datasheet for [BKMU 90°](#)

BKFU 90°, short, lockseamed bend

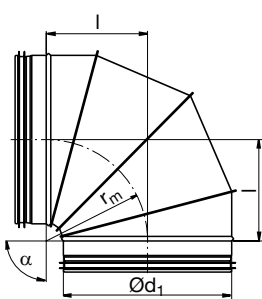

Ød, nom	Comment
200	For more detailed information about technical data and measures see datasheet for BKFU 90°
250	
315	
355	
400	
500	
630	
710	
800	
1000	
1120	
1250	

BKFMU 90°, short, segmented bend with female end

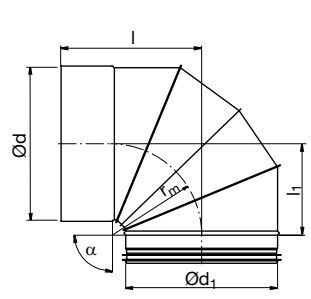

Ød, nom	Comment
200	For more detailed information about technical data and measures see datasheet for BKFMU 90°
250	
315	
400	
500	
630	
710	
800	
1000	
1120	
1250	

Circular duct system

Bends

BSFU 90°, long, lockseamed bend

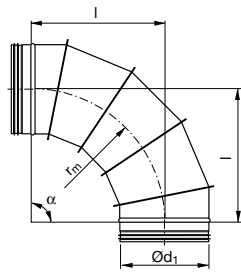

BSFU 45°, long, lockseamed bend

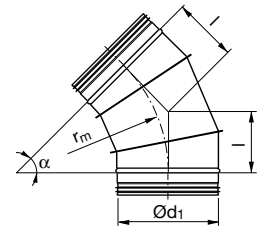

Ød, nom	Comment
250	
280	
300	
315	
355	
400	
450	
500	
560	For more detailed information about technical data and measures see datasheet for BSFU 90°
600	
630	
710	
800	
900	
1000	
1120	
1250	

Ød, nom	Comment
250	
280	
300	
315	
355	
400	
450	
500	
560	For more detailed information about technical data and measures see datasheet for BSFU 45°
600	
630	
710	
800	
900	
1000	
1120	
1250	

Circular duct system

Cleaning bends

BKCU 90°, cleaning bend

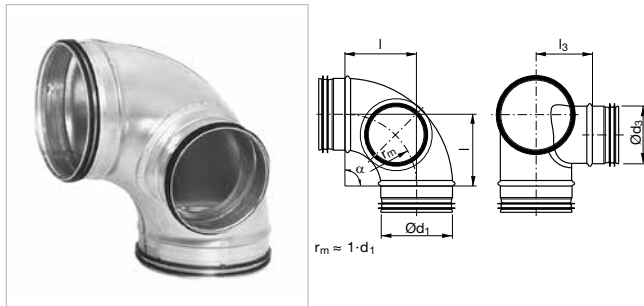

Ød ₁ nom	Ød ₃		
	100	125	160
100	•		
125	•	•	
160		•	•

Comment: For more detailed information about technical data and measures see datasheet for [BKCU 90°](#)

- Available dimensions

Are only available in EN 1.4404.

BBKCU 90°, cleaning bend

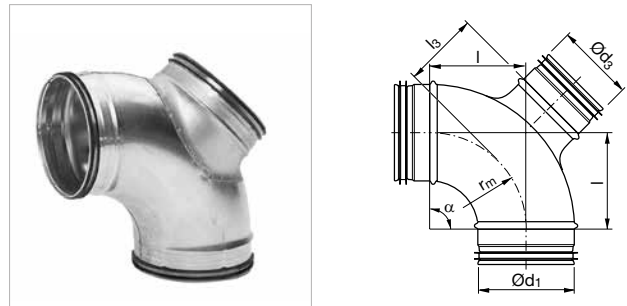

Ød ₁ nom	Ød ₃		
	100	125	160
100	•		
125	•	•	
160		•	•

Comment: For more detailed information about technical data and measures see datasheet for [BBKCU 90°](#)

- Available dimensions

Are only available in EN 1.4404.

BFKCU 90°, cleaning bend

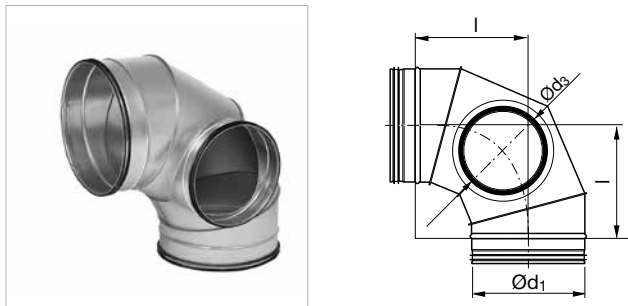

Ød ₁ nom	Ød ₃						
	100	125	160	200	250	315	400
112	•						
140		•					
150		•					
180			•				
200			•				
224				•			
250				•	•		
300					•		
315					•	•	
400						•	•

Comment: For more detailed information about technical data and measures see datasheet for [BFKCU 90°](#)

- Available dimensions

BFBKCU 90°, cleaning bend

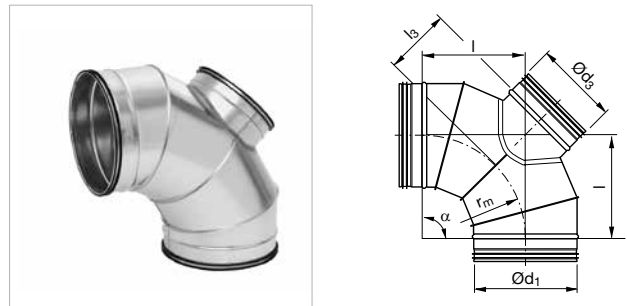

Ød ₁ nom	Ød ₃						
	100	125	160	200	250	315	400
112	•						
140		•					
150		•					
180			•				
200			•				
224				•			
250				•	•		
300					•		
315					•	•	
400						•	•

Comment: For more detailed information about technical data and measures see datasheet for [BFBKCU 90°](#)

- Available dimensions



Circular duct system

Reducers

RCU, reducer

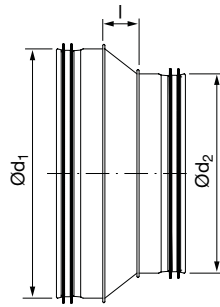

Ød ₁ nom	Ød ₂												
	63	80	100	125	150	160	180	200	224	250	315	400	500
80	•												
100	•	•											
125		•	•										
150			•	•									
160		•	•	•	•								
180			•	•	•	•							
200			•	•	•	•	•						
224					•	•	•	•					
250				•	•	•	•	•	•				
300								•		•			
315						•		•		•			
355										•	•		
400								•		•	•		
500										•	•	•	
630											•	•	•

Comment: For more detailed information about technical data and measures see datasheet for [RCU](#)

- Available dimensions

Circular duct system

Reducers

RCFU, reducer with female end

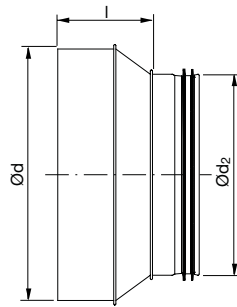

Ød nom	Ød ₂												
	63	80	100	125	150	160	180	200	224	250	315	400	500
80	•												
100	•	•											
125		•	•										
150			•	•									
160			•	•	•								
180			•	•	•	•							
200			•	•	•	•	•						
224					•	•	•	•					
250				•	•	•	•	•	•				
300								•		•			
315						•		•		•			
355										•	•		
400								•		•	•		
500										•	•	•	
630											•	•	•

Comment: For more detailed information about technical data and measures see datasheet for [RCFU](#)

- Available dimensions

Circular duct system

Reducers

RU, eccentric reducer

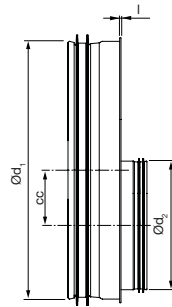

Ød ₁ nom	Ød ₂																	
	200	224	250	280	300	315	355	400	450	500	560	600	630	710	800	900	1000	1120
400	•	•	•	•	•	•	•											
450			•	•	•	•	•	•										
500			•	•	•	•	•	•	•									
560						•	•	•	•	•								
600						•	•	•	•	•	•							
630						•	•	•	•	•	•	•						
710								•	•	•	•	•	•					
800								•	•	•	•	•	•	•				
900									•	•	•	•	•	•	•			
1000										•	•	•	•	•	•	•		
1120													•	•	•	•	•	
1250													•	•	•	•	•	•

Comment: For more detailed information about technical data and measures see datasheet for [RU](#)

- Available dimensions

Circular duct system

Reducers

RFU, eccentric reducer with female end

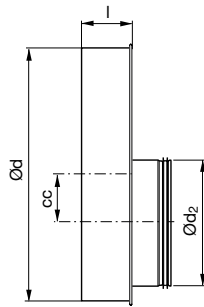

Ød nom	Ød ₂																	
	200	224	250	280	300	315	355	400	450	500	560	600	630	710	800	900	1000	1120
400	•	•	•	•	•	•	•											
450			•	•	•	•	•	•										
500			•	•	•	•	•	•	•									
560						•	•	•	•	•								
600						•	•	•	•	•	•							
630						•	•	•	•	•	•	•						
710								•	•	•	•	•	•					
800								•	•	•	•	•	•	•				
900										•	•	•	•	•	•			
1000										•	•	•	•	•	•	•		
1120													•	•	•	•	•	
1250													•	•	•	•	•	•

Comment: For more detailed information about technical data and measures see datasheet for [RFU](#)

- Available dimensions

Circular duct system

Reducers

RFLU, long, tangential reducer with female end

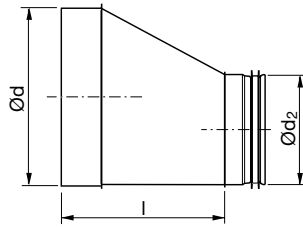

Ød nom	Ød ₂																											
	63	80	100	112	125	140	150	160	180	200	224	250	280	300	315	355	400	450	500	560	600	630	710	800	900	1000	1120	
80	•																											
100	•	•																										
112	•	•	•																									
125	•	•		•																								
140	•	•		•	•																							
150	•	•	•	•	•	•																						
160	•	•	•	•	•	•	•																					
180		•	•	•	•	•	•	•																				
200		•	•	•	•	•	•	•	•																			
224			•	•	•	•	•	•	•	•																		
250			•	•	•	•	•	•	•	•	•																	
280					•	•	•	•	•	•	•	•																
300					•	•	•	•	•	•	•	•	•															
315					•	•	•	•	•	•	•	•	•	•														
355								•	•	•	•	•	•	•	•													
400								•	•	•	•	•	•	•	•	•												
450										•	•	•	•	•	•	•	•											
500										•	•	•	•	•	•	•	•	•										
560										•	•	•	•	•	•	•	•	•	•									
600										•	•	•	•	•	•	•	•	•	•	•								
630										•	•	•	•	•	•	•	•	•	•	•	•							
710															•	•	•	•	•	•	•	•	•					
800																	•	•	•	•	•	•	•	•	•			
900																	•	•	•	•	•	•	•	•	•	•		
1000																			•	•	•	•	•	•	•	•	•	
1120																			•	•	•	•	•	•	•	•	•	
1250																				•	•	•	•	•	•	•	•	•

Comment: For more detailed information about technical data and measures see datasheet for [RFLU](#)

- Available dimensions



Circular duct system

Reducers

RCLU, long, concentric reducer

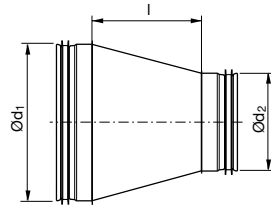

Ød ₁ nom	Ød ₂																											
	63	80	100	112	125	140	150	160	180	200	224	250	280	300	315	355	400	450	500	560	600	630	710	800	900	1000	1120	
112	•	•	•																									
125	•			•																								
140	•	•	•	•	•																							
150	•	•		•		•																						
160	•			•		•																						
180		•		•		•																						
200		•		•		•																						
224			•	•	•	•																						
250			•	•		•																						
280					•	•	•	•	•	•	•	•																
300					•	•	•	•	•	•	•		•															
315					•	•	•		•	•	•		•	•														
355								•	•	•	•	•	•	•														
400								•	•		•		•	•		•												
450										•	•	•	•	•	•	•	•											
500										•	•	•	•	•	•	•	•	•										
560												•	•	•	•	•	•	•	•	•								
600												•	•	•	•	•	•	•	•	•	•							
630												•	•	•	•	•	•	•	•	•	•	•						
710																•	•	•	•	•	•	•	•					
800																	•	•	•	•	•	•	•	•	•			
900																		•	•	•	•	•	•	•	•	•		
1000																			•	•	•	•	•	•	•	•	•	
1120																				•	•	•	•	•	•	•	•	
1250																					•	•	•	•	•	•	•	•

Comment: For more detailed information about technical data and measures see datasheet for [RCLU](#)

- Available dimensions



Circular duct system

Reducers

RCFLU, long, concentric reducer with female end

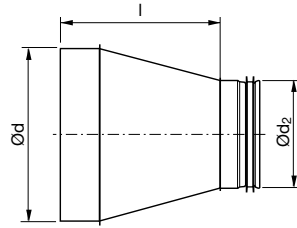

Ød nom	Ød ₂																											
	63	80	100	112	125	140	150	160	180	200	224	250	280	300	315	355	400	450	500	560	600	630	710	800	900	1000	1120	
80	•																											
100	•	•																										
112	•	•	•																									
125	•	•	•	•																								
140	•	•	•	•	•																							
150	•	•	•	•	•	•																						
160	•	•	•	•	•	•	•																					
180		•	•	•	•	•	•	•																				
200		•	•	•	•	•	•	•	•																			
224			•	•	•	•	•	•	•	•																		
250			•	•	•	•	•	•	•	•	•																	
280					•	•	•	•	•	•	•	•																
300					•	•	•	•	•	•	•	•	•															
315					•	•	•	•	•	•	•	•	•	•														
355								•	•	•	•	•	•	•	•													
400								•	•	•	•	•	•	•	•	•												
450										•	•	•	•	•	•	•	•											
500										•	•	•	•	•	•	•	•	•										
560											•	•	•	•	•	•	•	•	•									
600												•	•	•	•	•	•	•	•	•								
630												•	•	•	•	•	•	•	•	•	•							
710																•	•	•	•	•	•	•	•					
800																	•	•	•	•	•	•	•	•	•			
900																		•	•	•	•	•	•	•	•	•		
1000																			•	•	•	•	•	•	•	•	•	
1120																				•	•	•	•	•	•	•	•	
1250																						•	•	•	•	•	•	•

Comment: For more detailed information about technical data and measures see datasheet for [RCFLU](#)

- Available dimensions



Circular duct system

Reducers

RLU, long tangential reducer

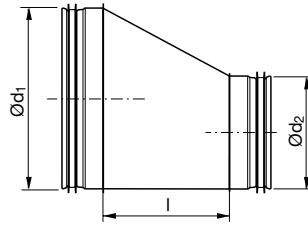

Ød ₁ nom	Ød ₂																											
	63	80	100	112	125	140	150	160	180	200	224	250	280	300	315	355	400	450	500	560	600	630	710	800	900	1000	1120	
80	•																											
100	•	•																										
112	•	•	•																									
125	•	•	•	•																								
140	•	•	•	•	•																							
150	•	•	•	•	•	•																						
160	•	•	•	•	•	•	•																					
180		•	•	•	•	•	•	•																				
200		•	•	•	•	•	•	•	•																			
224			•	•	•	•	•	•	•	•																		
250			•	•	•	•	•	•	•	•	•																	
280					•	•	•	•	•	•	•	•																
300					•	•	•	•	•	•	•	•	•															
315					•	•	•	•	•	•	•	•	•	•														
355								•	•	•	•	•	•	•	•													
400								•	•	•	•	•	•	•	•	•												
450										•	•	•	•	•	•	•	•											
500										•	•	•	•	•	•	•	•	•										
560											•	•	•	•	•	•	•	•	•									
600												•	•	•	•	•	•	•	•	•								
630												•	•	•	•	•	•	•	•	•	•							
710																•	•	•	•	•	•	•						
800																	•	•	•	•	•	•	•	•				
900																		•	•	•	•	•	•	•	•	•		
1000																			•	•	•	•	•	•	•	•	•	
1120																				•	•	•	•	•	•	•	•	•
1250																						•	•	•	•	•	•	•

Comment: For more detailed information about technical data and measures see datasheet for [RLU](#)

- Available dimensions



Circular duct system

T-pieces

TCU, centric T-piece

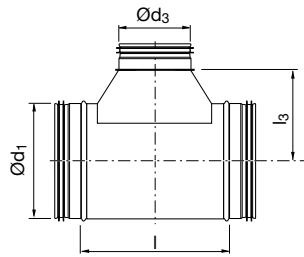

$\varnothing d_1$ nom	$\varnothing d_3$																											
	63	80	100	112	125	140	150	160	180	200	224	250	280	300	315	355	400	450	500	560	600	630	710	800	900	1000	1120	1250
63	•*	•	•																									
80	•*	•*		•	•																							
100	•*	•*	•*	•	•	•	•	•																				
112	•*	•*	•*	•	•	•	•	•	•																			
125	•*	•*	•*	•*	•*	•	•	•	•	•																		
140	•	•*	•*	•*	•	•*	•	•	•	•	•																	
150	•	•*	•*	•	•*	•*	•*	•*	•	•	•	•																
160	•	•*	•*		•*	•*	•*	•*		•	•	•																
180	•	•*	•*	•	•*	•*	•*	•*	•*	•	•	•	•															
200	•	•*	•*	•	•*	•*	•*	•*	•*	•*	•	•	•	•														
224	•	•*	•*	•	•*	•*	•*	•*	•*	•*	•*	•	•	•	•													
250	•	•*	•*	•	•*	•*	•*	•*	•*	•*	•*	•*	•	•	•	•	•											
280		•*	•*	•	•*	•*	•*	•*	•*	•*	•*	•	•	•	•	•	•	•										
300				•								•	•	•	•	•	•	•	•									
315		•*	•*	•	•*			•*		•*		•*			•*	•	•	•	•	•								
355				•								•			•	•	•	•	•	•								
400			•*	•	•*	•	•	•*	•	•*	•*	•*	•	•	•*	•	•*	•	•	•	•	•	•	•	•	•	•	•
450			•*		•*	•	•	•*	•	•*	•*	•*	•	•*	•*	•*	•*	•	•	•	•	•	•	•	•	•	•	•
500			•*		•*	•	•	•*	•	•*	•	•*	•	•*	•*	•*	•*	•	•	•	•	•	•	•	•	•	•	•
560			•*		•*			•*		•*	•	•*	•	•*	•*	•*	•*	•	•	•	•	•	•	•	•	•	•	•
600			•*		•*			•*		•*	•	•*	•	•*	•*	•*	•*	•	•	•	•	•	•	•	•	•	•	•
630			•*		•*			•*		•*	•	•*	•	•*	•*	•*	•*	•	•	•	•	•	•	•	•	•	•	•
710												•	•	•	•	•	•	•	•	•	•	•	•	•	•	•	•	•
800												•	•	•	•	•	•	•	•	•	•	•	•	•	•	•	•	•
900																												
1000																												
1120																												
1250																												

Comment: For more detailed information about technical data and measures see datasheet for [TCU](#)

- Available dimensions
- * Only available in stainless steel. When made in galvanized this dimension is pressed, see [TCPU](#)



Circular duct system

T-pieces

TU, tangential T-piece

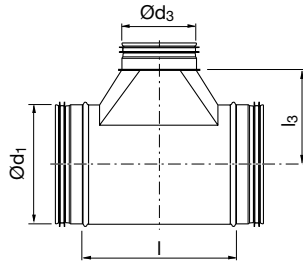

Ød ₁ nom	Ød ₃																												
	63	80	100	112	125	140	150	160	180	200	224	250	280	300	315	355	400	450	500	560	600	630	710	800	900	1000	1120	1250	
63	•	•	•																										
80	•	•	•	•	•																								
100	•	•	•	•	•	•	•	•																					
112	•	•	•	•	•	•	•	•	•																				
125	•	•	•	•	•	•	•	•	•	•																			
140	•	•	•	•	•	•	•	•	•	•	•																		
150	•	•	•	•	•	•	•	•	•	•	•	•																	
160	•	•	•	•	•	•	•	•	•	•	•	•																	
180	•	•	•	•	•	•	•	•	•	•	•	•	•																
200	•	•	•	•	•	•	•	•	•	•	•	•	•	•															
224	•	•	•	•	•	•	•	•	•	•	•	•	•	•	•														
250	•	•	•	•	•	•	•	•	•	•	•	•	•	•	•	•													
280		•	•	•	•	•	•	•	•	•	•	•	•	•	•	•	•												
300		•	•	•	•	•	•	•	•	•	•	•	•	•	•	•	•	•											
315		•	•	•	•	•	•	•	•	•	•	•	•	•	•	•	•	•	•										
355			•	•	•	•	•	•	•	•	•	•	•	•	•	•	•	•	•	•									
400			•	•	•	•	•	•	•	•	•	•	•	•	•	•	•	•	•	•	•								
450				•	•	•	•	•	•	•	•	•	•	•	•	•	•	•	•	•	•	•							
500					•	•	•	•	•	•	•	•	•	•	•	•	•	•	•	•	•	•	•						
560										•	•	•	•	•	•	•	•	•	•	•	•	•	•	•					
600										•	•	•	•	•	•	•	•	•	•	•	•	•	•	•	•				
630										•	•	•	•	•	•	•	•	•	•	•	•	•	•	•	•	•			
710											•	•	•	•	•	•	•	•	•	•	•	•	•	•	•	•	•		
800											•	•	•	•	•	•	•	•	•	•	•	•	•	•	•	•	•	•	
900												•	•	•	•	•	•	•	•	•	•	•	•	•	•	•	•	•	
1000													•	•	•	•	•	•	•	•	•	•	•	•	•	•	•	•	
1120														•	•	•	•	•	•	•	•	•	•	•	•	•	•	•	
1250															•	•	•	•	•	•	•	•	•	•	•	•	•	•	

Comment: For more detailed information about technical data and measures see datasheet for [TU](#)

- Available dimensions



Circular duct system

T-pieces

TSTCU, centric T-piece

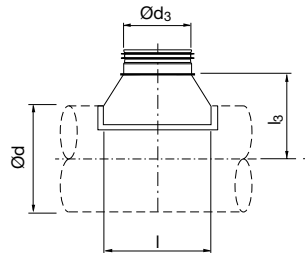

Ød nom	Ød ₃																											
	63	80	100	112	125	140	150	160	180	200	224	250	280	300	315	355	400	450	500	560	600	630	710	800	900	1000	1120	1250
63		•	•																									
80		•*	•	•	•																							
100		•*	•*	•	•	•	•	•																				
112				•	•	•	•	•	•																			
125		•*	•*	•	•*	•	•	•	•	•																		
140		•		•			•	•	•	•	•																	
150		•		•			•	•	•	•	•	•																
160	•	•*	•*	•	•*			•*	•	•	•	•																
180	•	•		•	•	•	•	•		•	•	•	•															
200	•	•*	•*	•	•*			•*		•*	•	•	•	•	•													
224	•			•								•	•	•	•	•												
250	•		•*	•	•*			•*		•*		•*	•	•	•	•	•											
280				•								•	•	•	•	•	•	•										
300				•								•	•	•	•	•	•	•										
315		•*	•*	•	•*			•*		•*		•*	•		•*	•	•	•	•	•								
355				•								•	•	•	•	•	•	•	•	•								
400			•*	•	•*	•		•*	•	•*		•*	•		•*	•	•*	•	•	•	•	•	•	•	•	•	•	•
450						•			•			•				•	•	•	•	•	•	•	•	•	•	•	•	•
500						•			•			•				•	•	•	•	•	•	•	•	•	•	•	•	•
560												•				•	•	•	•	•	•	•	•	•	•	•	•	•
600												•				•	•	•	•	•	•	•	•	•	•	•	•	•
630												•				•	•	•	•	•	•	•	•	•	•	•	•	•
710												•	•	•	•	•	•	•	•	•	•	•	•	•	•	•	•	•
800												•	•	•	•	•	•	•	•	•	•	•	•	•	•	•	•	•
900															•	•	•	•	•	•	•	•	•	•	•	•	•	•
1000															•	•	•	•	•	•	•	•	•	•	•	•	•	•
1120																			•	•	•	•	•	•	•	•	•	•
1250																			•	•	•	•	•	•	•	•	•	•

Comment: For more detailed information about technical data and measures see datasheet for [TSTCU](#)

- Available dimensions
- * Only available in stainless steel. When made in galvanized this dimension is pressed, see [TCPU](#)



Circular duct system

T-pieces

TSTU, tangential T-piece

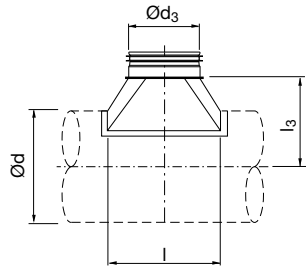

Ød nom	Ød ₃																											
	63	80	100	112	125	140	150	160	180	200	224	250	280	300	315	355	400	450	500	560	600	630	710	800	900	1000	1120	1250
63		•	•																									
80	•		•	•	•																							
100	•	•		•	•	•	•	•																				
112	•	•	•		•	•	•	•	•																			
125	•	•	•	•		•	•	•	•	•																		
140	•	•	•	•	•		•	•	•	•	•																	
150	•	•	•	•	•	•		•	•	•	•	•																
160	•	•	•	•	•	•	•		•	•	•	•																
180	•	•	•	•	•	•	•	•		•	•	•	•															
200	•	•	•	•	•	•	•	•	•		•	•	•	•														
224	•	•	•	•	•	•	•	•	•	•		•	•	•	•													
250	•	•	•	•	•	•	•	•	•	•	•		•	•	•	•												
280		•	•	•	•	•	•	•	•	•	•	•		•	•	•	•											
300		•	•	•	•	•	•	•	•	•	•	•	•		•	•	•	•										
315		•	•	•	•	•	•	•	•	•	•	•	•	•		•	•	•	•									
355			•	•	•	•	•	•	•	•	•	•	•	•	•		•	•	•	•								
400			•	•	•	•	•	•	•	•	•	•	•	•	•	•		•	•	•	•							
450					•	•	•	•	•	•	•	•	•	•	•	•	•		•	•	•	•	•					
500					•	•	•	•	•	•	•	•	•	•	•	•	•	•		•	•	•	•	•				
560										•	•	•	•	•	•	•	•	•	•		•	•	•	•	•			
600										•	•	•	•	•	•	•	•	•	•	•		•	•	•	•	•		
630										•	•	•	•	•	•	•	•	•	•	•	•		•	•	•	•	•	
710											•	•	•	•	•	•	•	•	•	•	•	•		•	•	•	•	
800											•	•	•	•	•	•	•	•	•	•	•	•	•		•	•	•	
900												•	•	•	•	•	•	•	•	•	•	•	•	•		•	•	
1000													•	•	•	•	•	•	•	•	•	•	•	•	•		•	
1120																				•	•	•	•	•	•	•	•	
1250																				•	•	•	•	•	•	•	•	

Comment: For more detailed information about technical data and measures see datasheet for [TSTU](#).

- Available dimensions



Circular duct system

X-pieces

XCU, centric X-piece

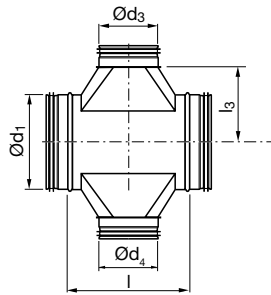

$\varnothing d_1$ nom	$\varnothing d_3 \varnothing d_4$																											
	63	80	100	112	125	140	150	160	180	200	224	250	280	300	315	355	400	450	500	560	600	630	710	800	900	1000	1120	1250
63	•																											
80	•	•																										
100	•	•	•																									
112	•	•	•	•																								
125	•	•	•	•	•																							
140	•	•	•	•	•	•																						
150	•	•	•	•	•	•	•																					
160	•	•	•	•	•	•	•	•																				
180	•	•	•	•	•	•	•	•	•																			
200	•	•	•	•	•	•	•	•	•	•																		
224	•	•	•	•	•	•	•	•	•	•	•																	
250	•	•	•	•	•	•	•	•	•	•	•	•																
280		•	•	•	•	•	•	•	•	•	•	•	•															
300		•	•	•	•	•	•	•	•	•	•	•	•	•														
315		•	•	•	•	•	•	•	•	•	•	•	•	•	•													
355			•	•	•	•	•	•	•	•	•	•	•	•	•	•												
400			•	•	•	•	•	•	•	•	•	•	•	•	•	•	•											
450				•	•	•	•	•	•	•	•	•	•	•	•	•	•	•										
500					•	•	•	•	•	•	•	•	•	•	•	•	•	•	•									
560										•	•	•	•	•	•	•	•	•	•	•								
600										•	•	•	•	•	•	•	•	•	•	•	•							
630										•	•	•	•	•	•	•	•	•	•	•	•	•						
710												•	•	•	•	•	•	•	•	•	•	•	•					
800												•	•	•	•	•	•	•	•	•	•	•	•	•				
900															•	•	•	•	•	•	•	•	•	•	•	•		
1000															•	•	•	•	•	•	•	•	•	•	•	•	•	
1120																				•	•	•	•	•	•	•	•	•
1250																				•	•	•	•	•	•	•	•	•

Comment: For more detailed information about technical data and measures see datasheet for [XCU](#).

- Available dimensions



Circular duct system

X-pieces

XU, tangential X-piece

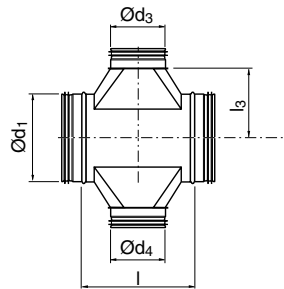

Ød ₁ nom	Ød ₃ Ød ₄																											
	63	80	100	112	125	140	150	160	180	200	224	250	280	300	315	355	400	450	500	560	600	630	710	800	900	1000	1120	
80	•																											
100	•	•																										
112	•	•	•																									
125	•	•	•	•																								
140	•	•	•	•	•																							
150	•	•	•	•	•	•																						
160	•	•	•	•	•	•	•																					
180	•	•	•	•	•	•	•	•																				
200	•	•	•	•	•	•	•	•	•																			
224	•	•	•	•	•	•	•	•	•	•																		
250	•	•	•	•	•	•	•	•	•	•	•																	
280		•	•	•	•	•	•	•	•	•	•	•																
300		•	•	•	•	•	•	•	•	•	•	•	•															
315		•	•	•	•	•	•	•	•	•	•	•	•	•														
355			•	•	•	•	•	•	•	•	•	•	•	•	•													
400			•	•	•	•	•	•	•	•	•	•	•	•	•	•												
450					•	•	•	•	•	•	•	•	•	•	•	•	•											
500					•	•	•	•	•	•	•	•	•	•	•	•	•	•										
560										•	•	•	•	•	•	•	•	•	•									
600										•	•	•	•	•	•	•	•	•	•	•								
630										•	•	•	•	•	•	•	•	•	•	•	•							
710												•	•	•	•	•	•	•	•	•	•	•						
800												•	•	•	•	•	•	•	•	•	•	•	•					
900														•	•	•	•	•	•	•	•	•	•	•				
1000															•	•	•	•	•	•	•	•	•	•	•	•		
1120																			•	•	•	•	•	•	•	•	•	
1250																				•	•	•	•	•	•	•	•	•

Comment: For more detailed information about technical data and measures see datasheet for [XU](#).

- Available dimensions



Circular duct system

Take-offs

ILU, take-off without radius

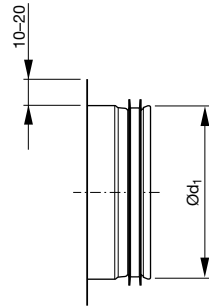

ILF, take-off without radius with female end

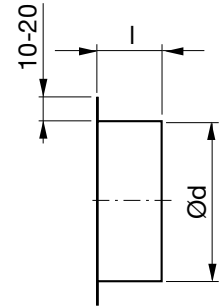

Ød, nom	Comment
63	
80	
100	
112	
125	
140	
150	
160	
180	
200	
224	
250	
280	
300	For more detailed information about technical data and measures see datasheet for ILU .
315	
355	
400	
450	
500	
560	
600	
630	
710	
800	
900	
1000	
1120	
1250	

Ød nom	Comment
63	
80	
100	
112	
125	
140	
150	
160	
180	
200	
224	
250	
280	
300	For more detailed information about technical data and measures see datasheet for ILF .
315	
355	
400	
450	
500	
560	
600	
630	
710	
800	
900	
1000	
1120	
1250	

Circular duct system

Take-offs

ESNU, take-off with mesh

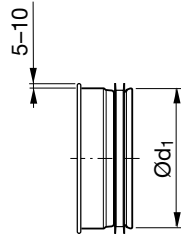

EPNF, take-off with mesh and female end

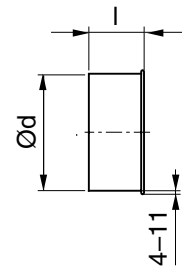

Ød, nom	Comment
63	
80	
100	
112	
125	
140	
150	
160	
180	
200	
224	
250	
280	
300	For more detailed information about technical data and measures see datasheet for ESNU .
315	
355	
400	
450	
500	
560	
600	
630	
710	
800	
900	
1000	
1120	
1250	

Ød nom	Comment
63	
80	
100	
112	
125	
140	
150	
160	
180	
200	
224	
250	
280	
300	For more detailed information about technical data and measures see datasheet for EPNF .
315	
355	
400	
450	
500	
560	
600	
630	
710	
800	
900	
1000	
1120	
1250	

Circular duct system

Take-offs

ILKNU 50, take-off with mesh and cone

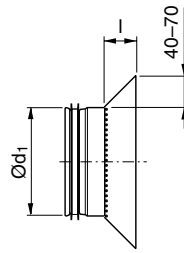

ILKNU 100, take-off with mesh and cone

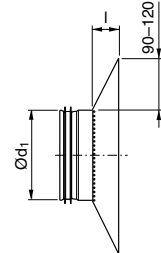

$\varnothing d, \text{nom}$	Comment
80	For more detailed information about technical data and measures see datasheet for ILKNU 50 .
100	
125	
160	
200	
250	
315	
400	
500	
630	
800	

$\varnothing d, \text{nom}$	Comment
80	For more detailed information about technical data and measures see datasheet for ILKNU 100 .
100	
125	
160	
200	
250	
315	
400	
500	
630	
800	

ILKNF 50, take-off with mesh, cone and female end

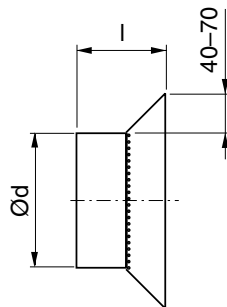

ILKNF 100, take-off with mesh, cone and female end

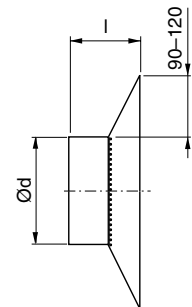

$\varnothing d, \text{nom}$	Comment
100	For more detailed information about technical data and measures see datasheet for ILKNF 50 .
125	
160	
200	
250	
315	
400	
500	
630	
800	

$\varnothing d, \text{nom}$	Comment
100	For more detailed information about technical data and measures see datasheet for ILKNF 100 .
125	
160	
200	
250	
315	
400	
500	
630	
800	

Circular duct system

Couplings

NPU, coupling

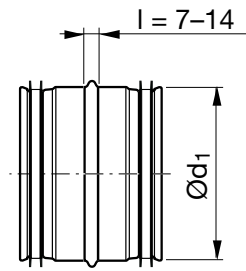

SNPU, slide-in coupling

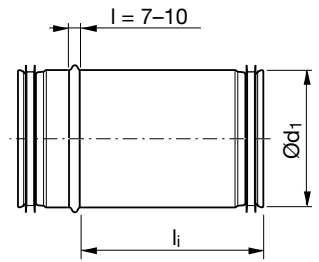

Ød, nom	Comment
63	
80	
100	
112	
125	
140	
150	
160	
180	
200	
224	
250	
280	
300	
315	
355	
400	
450	
500	
560	
600	
630	
710	
800	
900	
1000	
1120	
1250	

For more detailed information about technical data and measures see datasheet for [NPU](#).

Ød, nom	Comment
80	
100	
112	
125	
140	
150	
160	
180	
200	
224	
250	
280	
300	
315	
355	
400	
450	
500	
560	
630	
800	
1000	
1250	

All dimensions available in nominal lengths 150 mm, 300 mm and 500 mm.

For more detailed information about technical data and measures see datasheet for [SNPU](#).

Circular duct system

Couplings

MF, female coupling

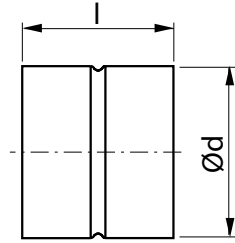

SMFU, slide-in female coupling

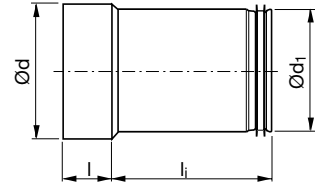

Ød nom	Comment
63	
80	
100	
112	
125	
140	
150	
160	
180	
200	
224	
250	
280	
300	For more detailed information about technical data and measures see datasheet for MF .
315	
355	
400	
450	
500	
560	
600	
630	
710	
800	
900	
1000	
1120	
1250	

Ød ₁ nom	l mm	Comment	
80			
100			
112			
125			
140			
150			
160			
180	150, 300 or 500	For more detailed information about technical data and measures see datasheet for SMFU .	
200			
224			
250			
280			
300			
315			
355			
400	300 or 500		
450			
500			
560			
630			
800	500		
1000			
1250			

Circular duct system

End caps

EPF, end cap

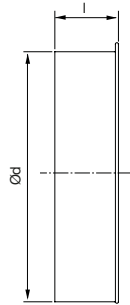

ESU, end cap

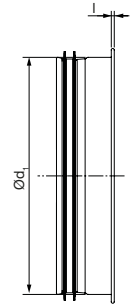

Ød nom	Comment
63	
80	
100	
112	
125	
140	
150	
160	
180	
200	
224	
250	
280	
300	For more detailed information about technical data and measures see datasheet for EPF .
315	
355	
400	
450	
500	
560	
600	
630	
710	
800	
900	
1000	
1120	
1250	

Ød, nom	Comment
63	
80	
100	
112	
125	
140	
150	
160	
180	
200	
224	
250	
280	
300	For more detailed information about technical data and measures see datasheet for ESU .
315	
355	
400	
450	
500	
560	
600	
630	
710	
800	
900	
1000	
1120	
1250	

Circular duct system

Access doors

EPFH, access door

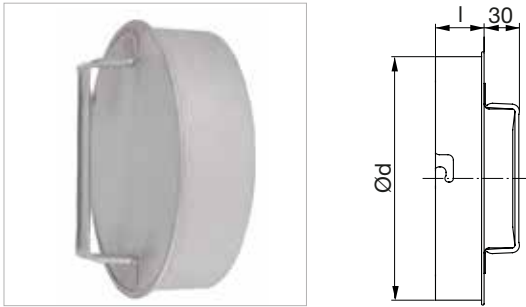

Ød nom	Comment
80	
100	
112	
125	
140	
150	
160	
180	
200	
224	
250	
280	
300	
315	
355	
400	
450	
500	
630	

For more detailed information about technical data and measures see datasheet for [EPFH](#).

ESHU, access door



Ød, nom	Comment
100	
112	
125	
140	
150	
160	
180	
200	
224	
250	
280	
300	
315	
355	
400	
450	
500	
630	

For more detailed information about technical data and measures see datasheet for [ESHU](#).

Circular duct system

Access doors

KCU, insulated access door

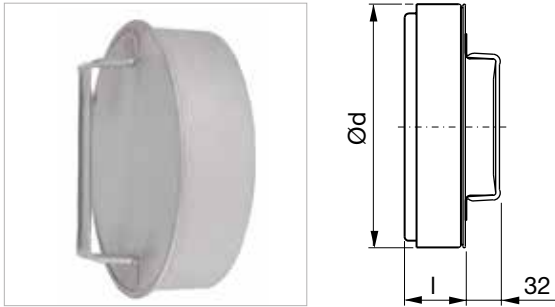

Ød nom	l	Insulation thickness	Comment
100	58	50	For more detailed information about technical data and measures see datasheet for KCU .
125	58	50	
160	58	50	
200	58	50	
250	58	50	
315	58	50	
400	94	50	
500	94	50	
630	94	50	

Circular duct system

Dampers

DRU, regulating damper

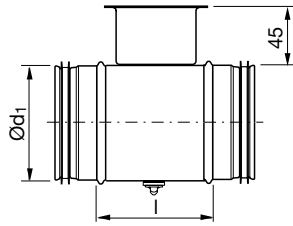

DSU, shut-off damper

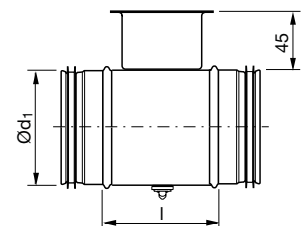

Ød, nom	Comment
80	
100	
112	
125	
140	
150	
160	
180	
200	
224	
250	
280	
300	
315	
355	
400	
450	
500	
560	
600	
630	

For more detailed information about technical data and measures see datasheet for [DRU](#).

Ød, nom	Comment
63	
80	
100	
112	
125	
140	
150	
160	
180	
200	
224	
250	
280	
300	
315	
355	
400	
450	
500	
560	
600	
630	

For more detailed information about technical data and measures see datasheet for [DSU](#).

Circular duct system

Dampers

DTU, shut-off damper

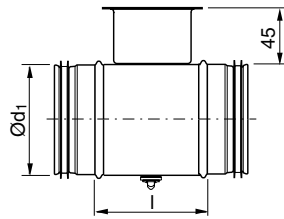

DTHU, shut-off damper with motor shelf

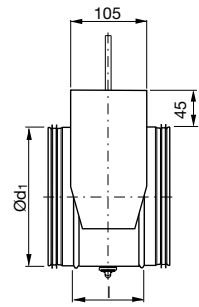

Ød, nom	Comment
80	
100	
112	
125	
140	
150	
160	
180	
200	
224	
250	For more detailed information about technical data and measures see datasheet for DTU .
280	
300	
315	
355	
400	
450	
500	
560	
600	
630	

Ød, nom	Comment
80	
100	
112	
125	
140	
150	
160	
180	
200	
224	
250	For more detailed information about technical data and measures see datasheet for DTHU .
280	
300	
315	
355	
400	
450	
500	
560	
600	
630	
800	
1000	

Circular duct system

UltraLink

FTCU, UltraLink Controller

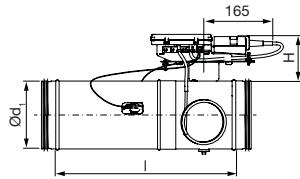

FTMU, UltraLink Monitor

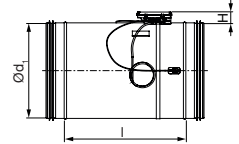

Ød, nom	Comment
100	For more detailed information about technical data and measures see datasheet for FTCU .
125	
160	
200	
250	
315	

Ød, nom	Comment
100	For more detailed information about technical data and measures see datasheet for FTMU .
125	
160	
200	
250	
315	
400	
500	
630	

Duct suspension and support system

MDH, duct holder

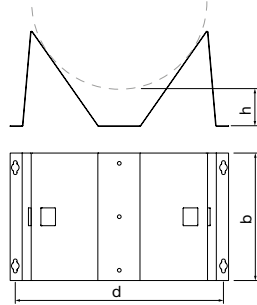

Ød nom	Comment
100	
112	
125	
140	
150	
160	
180	
200	
224	
250	
280	
300	
315	
355	
400	
450	
500	
560	
600	
630	
710	
800	
900	
1000	
1120	
1250	

For more detailed information about technical data and measures see datasheet for [MDH](#).

DH, duct holder

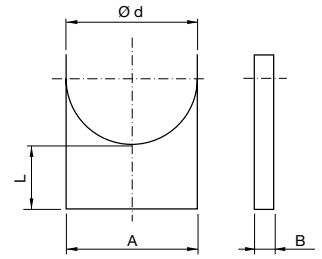

Ød nom	Comment
63	
80	
100	
125	
160	
200	
250	
315	
400	
500	
630	

For more detailed information about technical data and measures see datasheet for [DH](#).

FB 30, suspension band

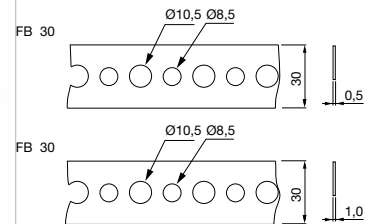

Width mm	Thickness mm	Length m	Comment
30	0,5	25	
30	1,0	25	

For more detailed information about technical data and measures see datasheet for [FB 30](#)

Are only available in EN 1.4301.

Duct suspension and support system

UV30, suspension rings

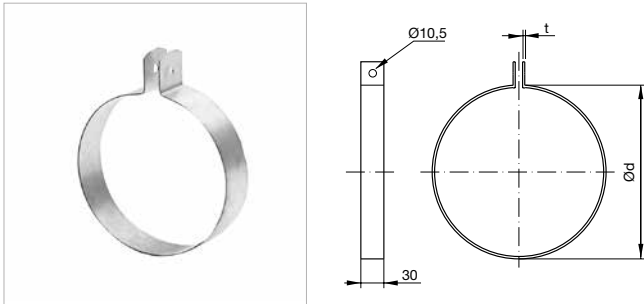

UV25, suspension rings

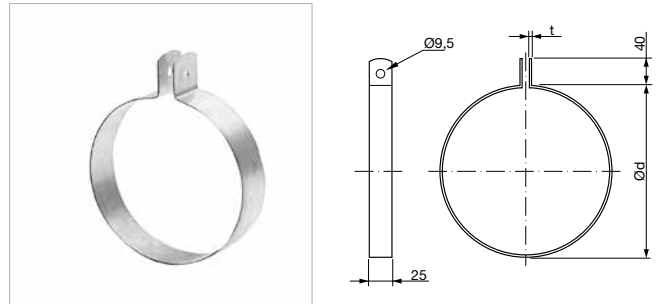

Ød nom	Comment
80	
100	
112	
125	
140	
150	
160	
175	
180	
200	
224	
250	
260	
280	
300	
315	
350	
355	
400	
415	
450	
500	
560	
600	
630	
710	
800	
850	
900	
1000	
1120	
1250	

For more detailed information about technical data and measures see datasheet for [UV30](#).

Ød nom	Comment
80	
100	
112	
125	
140	
150	
160	
175	
180	
200	
224	
250	
260	
280	
300	
315	
350	
355	
400	
415	
450	
500	
560	
600	
630	
710	
800	
850	
900	
1000	
1120	
1250	

For more detailed information about technical data and measures see datasheet for [UV25](#).

Are only available in EN 1.4404.

Are only available in EN 1.4404.

Duct suspension and support system

UVH30, suspension rings

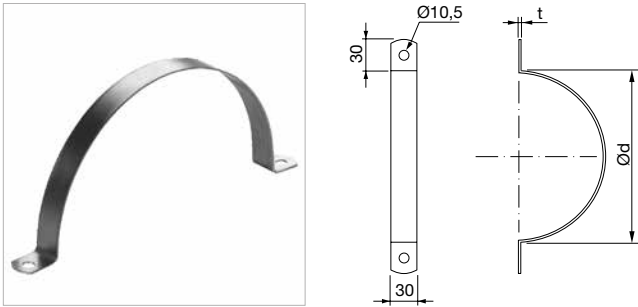

Ød nom	Comment
80	
100	
112	
125	
140	
150	
160	
175	
180	
200	
224	
250	
260	
280	
300	
315	
350	
355	
400	
415	
450	
500	
560	
600	
630	
710	
800	
850	
900	
1000	
1120	
1250	
1400	
1500	
1600	

For more detailed information about technical data and measures see datasheet for [UVH30](#).

Are only available in EN 1.4404.

Rectangular duct system

LKR, duct

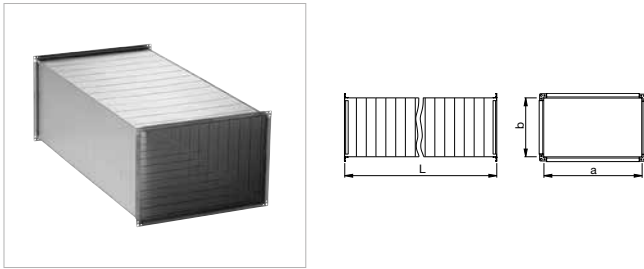

Comment

For more detailed information about technical data and measures see datasheet for [LKR](#).

LBR, bend (90° and 45°)

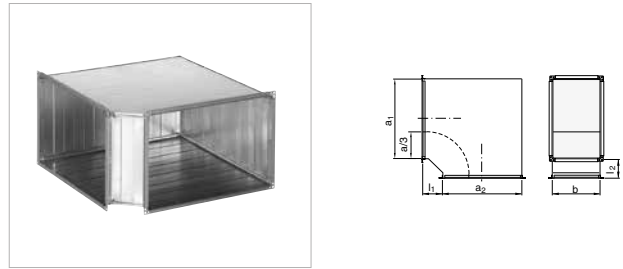

Comment

For more detailed information about technical data and measures see datasheet for [LBR](#).

LBXR, bend (90° and 45°)

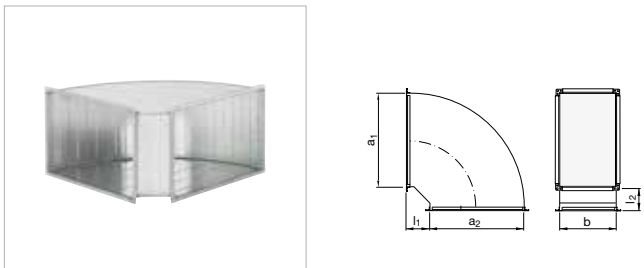

Comment

For more detailed information about technical data and measures see datasheet for [LBXR](#).

LBSR, s-bend

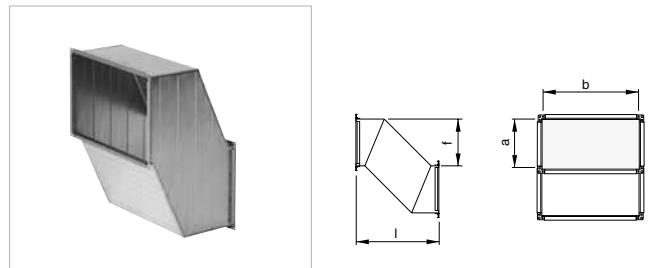

Comment

For more detailed information about technical data and measures see datasheet for [LBSR](#).

LDR, taper

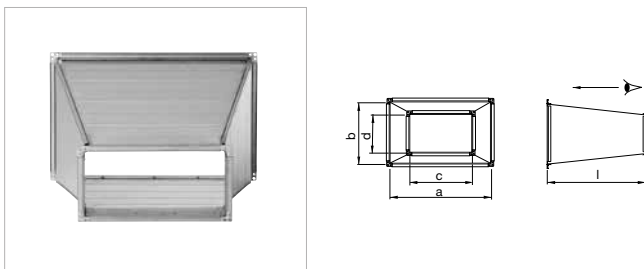

Comment

For more detailed information about technical data and measures see datasheet for [LDR](#).

LORU, rect-to-round transition

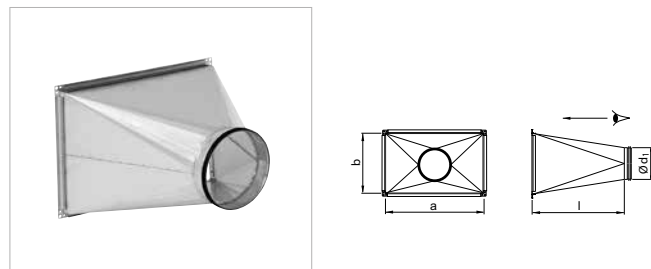

Comment

For more detailed information about technical data and measures see datasheet for [LORU](#).

Rectangular duct system

LAR, collar

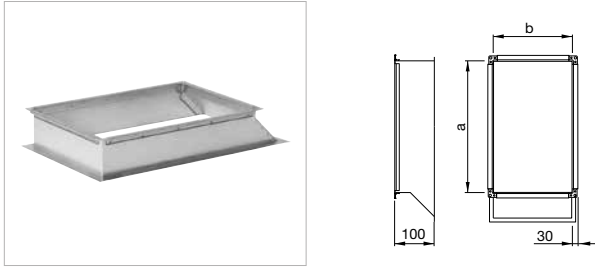

Comment

For more detailed information about technical data and measures see datasheet for [LAR](#).

LTTR, T-piece

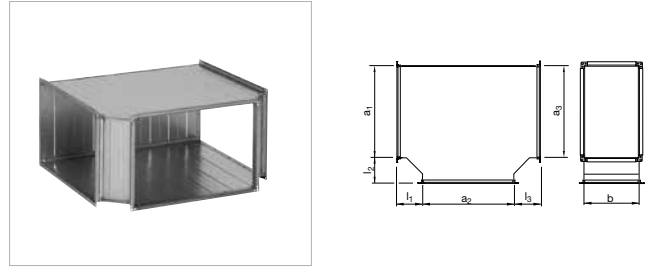

Comment

For more detailed information about technical data and measures see datasheet for [LTTR](#).

LEPR, end cover

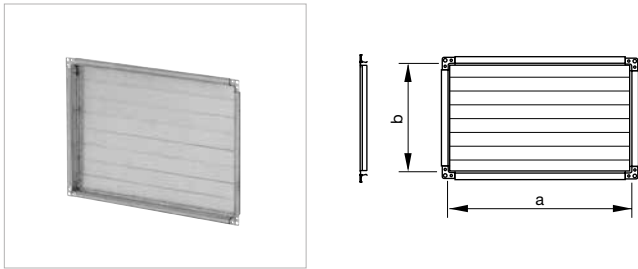

Comment

For more detailed information about technical data and measures see datasheet for [LEPR](#).

LPSR, collar on circular duct

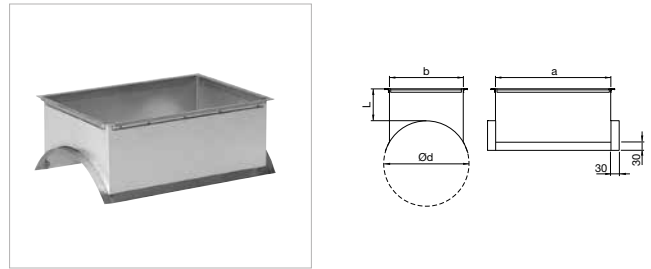

Comment

For more detailed information about technical data and measures see datasheet for [LPSR](#).

RJFP, flange profiles



Dim

20

40

Comment

For more detailed information about technical data and measures see datasheet for [RJFP3C](#).

RJBC, rectangular joint bolt clamp



Comment

For more detailed information about technical data and measures see datasheet for [RJBC](#).

Are only available in EN 1.4404.

Are only available in EN 1.4404.

Rectangular duct system

RJCL, corner



Dim	Comment
20	For more detailed information about technical data and measures see datasheet for RJCL .
40	

Are only available in EN 1.4404.

RJSP, rectangular joint slide profile



Comment
For more detailed information about technical data and measures see datasheet for RJSP .

Are only available in EN 1.4404.

Fasteners

Drill screw, hexagon head



Type	Comment
TG10	For more detailed information about technical data and measures see technical information for TG
TG12	

Drill screw, convex head



Type	Comment
SH11	For more detailed information about technical data and measures see technical information for SH
SH12	

Blind rivet, pressure-tight

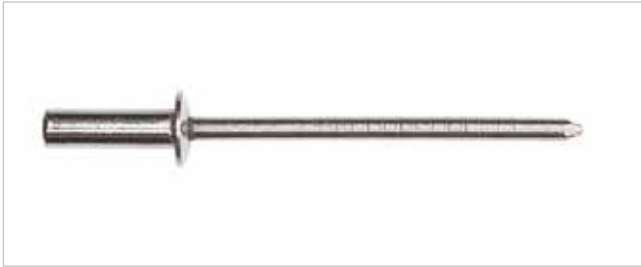

Type	Comment
RH13	For more detailed information about technical data and measures see technical information for RH
RH22	
RH31	
RH33	

Blind rivet, open



Type	Comment
RE12	For more detailed information about technical data and measures see technical information for RE
RE13	
RE14	
RE22	
RE24	

Other circular products

FL 4404, Flange



Ød nom	Comment
100	
125	
140	
150	
160	
180	
200	
224	
250	
280	
300	
315	
355	
400	
450	
500	
560	
600	
630	
710	
800	
900	
1000	
1120	
1250	

For more detailed information about technical data and measures see datasheet for [FL 4404](#).



Most of us spend the majority of our time indoors. Indoor climate is crucial to how we feel, how productive we are and if we stay healthy.

We at Lindab have therefore made it our most important objective to contribute to an indoor climate that improves people's lives. We do this by developing energy-efficient ventilation solutions and durable building products. We also aim to contribute to a better climate for our planet by working in a way that is sustainable for both people and the environment.

[Lindab | For a better climate](#)