

Lindab **Atrium Loggia** / -H / -C

Heating and cooling panels



Heating and cooling panels Atrium Loggia/-H/-C

Delivery control

Control the delivery!



Example of delivery code:

Atrium H & C/Loggia - 60 - 10 - 1 - 4.8 m.

Width, cm

Water connection, mm

Pipe connection type

Length, m.

Way of mounting	Included mounting details
Free mounted	4-6 adjustable pendulums (alternative chains) 4-6 angle brackets panel
Direct to ceiling	4-6 angle brackets outer

There are also included support sleeves that must be used in every connection pipe (when compression fittings are used, please refer to the suppliers installation instruction).

Lindab recommends 4 pieces of hangers for panels < 4.0 m and 6 pieces ≥ 4.0 m panels length.

View

Atrium H/C and Loggia could be mounted either direct to the concrete or hanging in pendulums. Atrium C and Loggia could also be integrated into false ceilings.

Direct to concrete



Free hanging

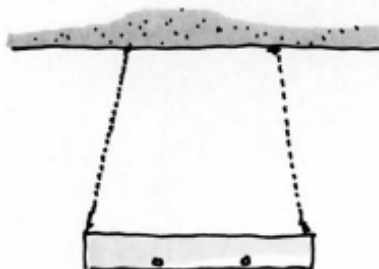

Integrated into false ceilings

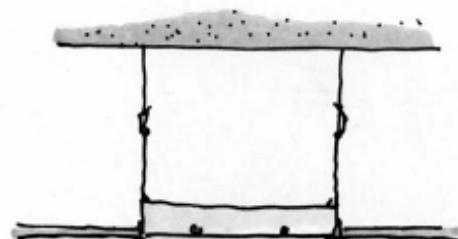

Heating and cooling panels Atrium Loggia/-H/-C

Mounting with adjustable pendulums

1.- Measure and drill into the ceiling for the strips/panels brackets. 4 pieces for lengths up to 4.0 m, 6 pieces for longer units.

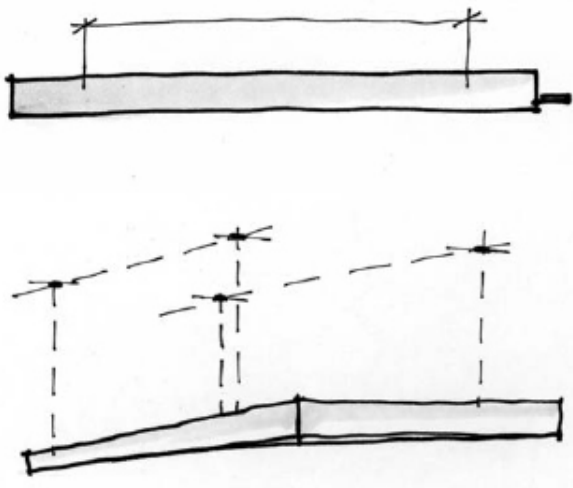

- 2.- Screw up the brackets into the ceiling
- 3.- Hang up the pendulums into these brackets.
- 4.- Hang up the strips/panel with the Atrium panel hook into the edge of the panel and connect the pendulums into these.

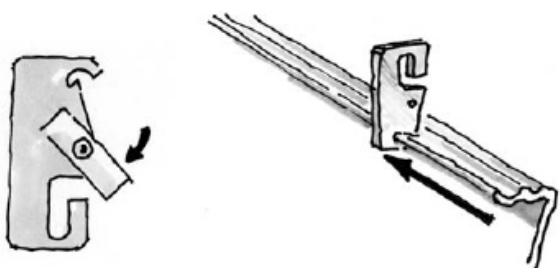

5.- Adjust the length of the pendulums. Also adjust after the false ceiling height if it's mounted into this.

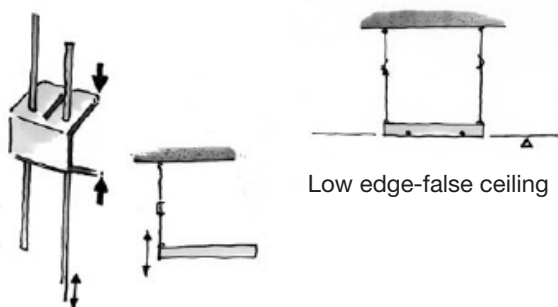

Mounting in chains

1.- Measure and drill into the ceiling for the strips/panels brackets. 4 pieces for lengths up to 4.0 m, 6 pieces for longer units. Observe that the chains must be angled inwards so the angle brackets will be secured.

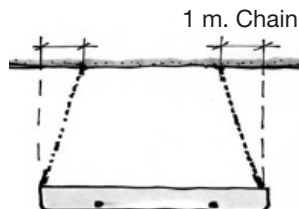

2.- Screw up the brackets for the chains into the ceiling.

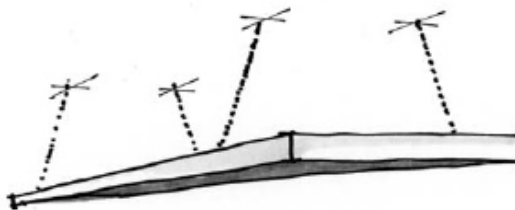

3.- Hang up the strips/panel with the Atrium panel hook into the edge of the panel.

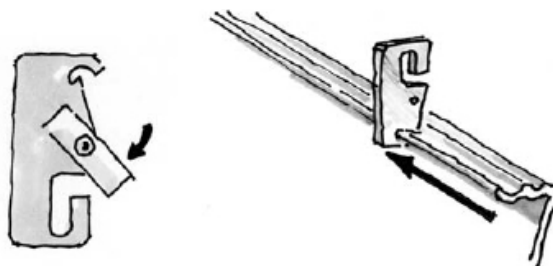

4.- Adjust the length of the chains as you see of the drawing.

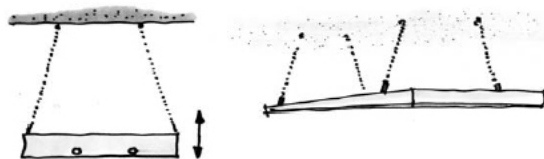

Mounting direct to concrete

1.- Measure and drill into the concrete for Atrium mounting brackets. Use 6 pieces with lengths above 4.0 m.

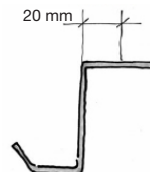

2.- Screw up the strips/panel against the concrete. Mounting with Atrium hanger for Sports hall

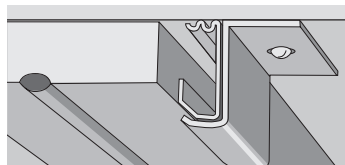

Heating and cooling panels Atrium Loggia/-H/-C

Water connection

Connection alternatives

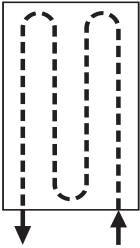
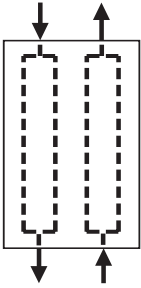
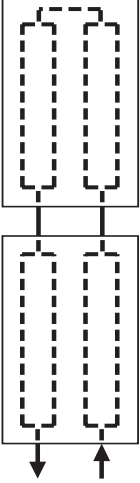
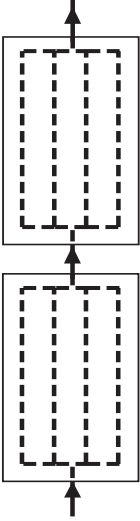
			
<p style="text-align: center;">1 (1 connected)</p> <p>The supply and return for this model are located in the same end-piece.</p> <p>This coupling is only available with one pipe dimension per panel width.</p> <p>Width 33: Ø10 mm Width 60: Ø10 + Ø12 mm Width 87: Ø10 + Ø15 mm</p>	<p style="text-align: center;">13 (double circuit)</p> <p>This model has the supply in one end-piece and the return in the other one.</p> <p>This coupling is only available with one pipe dimension per panel width.</p> <p>Width 33: Ø10 mm Width 60: Ø12 mm Width 87: Ø15 mm</p>	<p style="text-align: center;">1+13 (1 connected + double circuit)</p> <p>This model is a combination of 1 connected panel + 1 double circuit.</p> <p>This coupling is available with only one pipe dimension per panel width.</p> <p>Width 33: Ø10 mm Width 60: Ø12 mm Width 87: Ø15 mm</p>	<p style="text-align: center;">13+13 (straight through)</p> <p>This model has the supply in one end-piece and the return in the other one.</p> <p>This coupling is only available with one pipe dimension per panel width.</p> <p>Width 33: Ø12 mm Width 60: Ø15 mm Width 87: Ø22 mm</p>



Connect water with compression coupling or similar. Use the support sleeves. Do not solder !

Heating and cooling panels Atrium Loggia/-H/-C

False ceiling adaptation (Atrium H/C)

It is best if the false ceiling installer mount some head profiles before the beams will be mounted. This is to make it easier for the beam installer. If the head profiles already are mounted is it very important that you use a line/wire to have the beams in the right position.

1. Fix the head profiles against the panel with pop rivets or screws.



2. Mount the secondary profiles around the panel. Cut of the steering pins and fix with pop rivets.

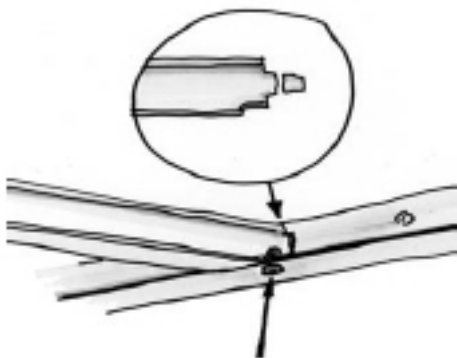

3. One of false ceiling plates and one secondary profile must be cut out, to make room for pipe connections (only with horizontal connection pipes.)

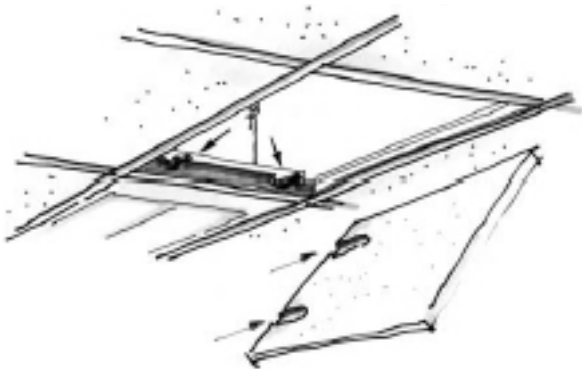

Mounting wire spring

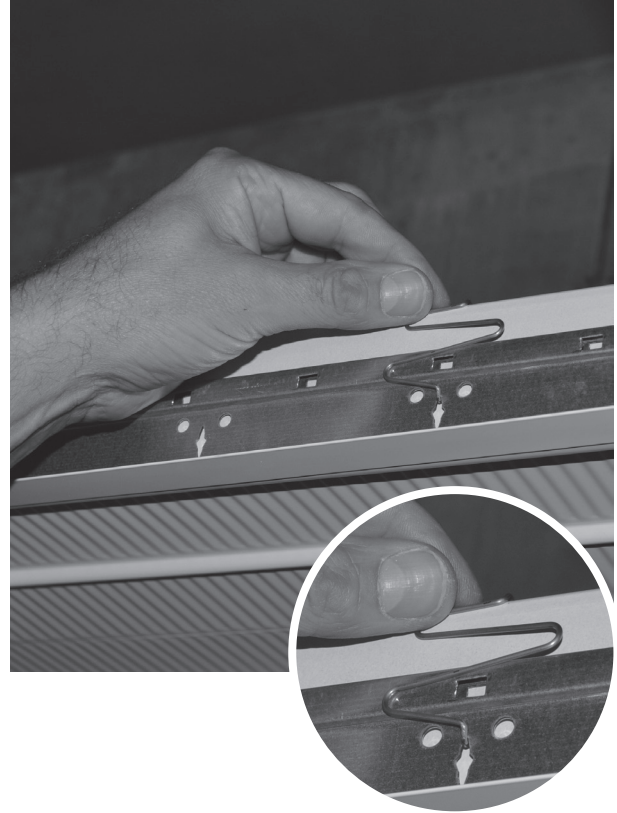

- 1.- Attach the ceiling clip into the ceiling grid.
- 2.- Press it over the top of the panel.
- 3.- Secure that the ceiling clip is attached between the ceiling grid and the heating panel.

Insulation of heating panels

The top of the Atrium H- and the Loggia panels are insulated with extruded polystyrene foam and should not be placed in direct sunshine or underneath other heating- or ignition sources. Sparks and smoke must be avoided. Keep places dry and ventilated and take precautions against static electricity.

The foamed plastic is manufactured without the addition of CFC or HCFC gas, i.e. Freons.

For full technical data sheet please contact Lindab.



Most of us spend the majority of our time indoors. Indoor climate is crucial to how we feel, how productive we are and if we stay healthy.

We at Lindab have therefore made it our most important objective to contribute to an indoor climate that improves people's lives. We do this by developing energy-efficient ventilation solutions and durable building products. We also aim to contribute to a better climate for our planet by working in a way that is sustainable for both people and the environment.

[Lindab](#) | For a better climate