

Regula Combi Installation

Mounting

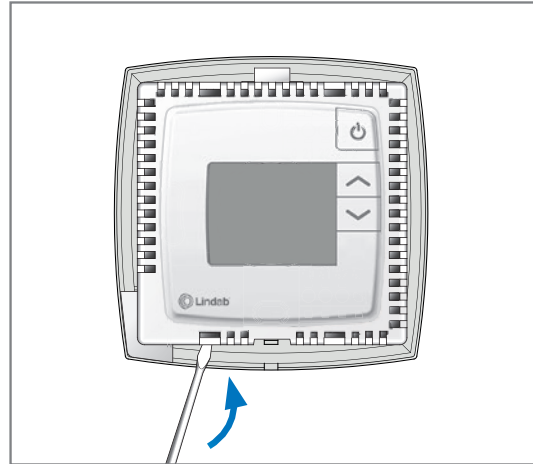

1. Demount the face plate.



2. Remove the front including the circuit board.

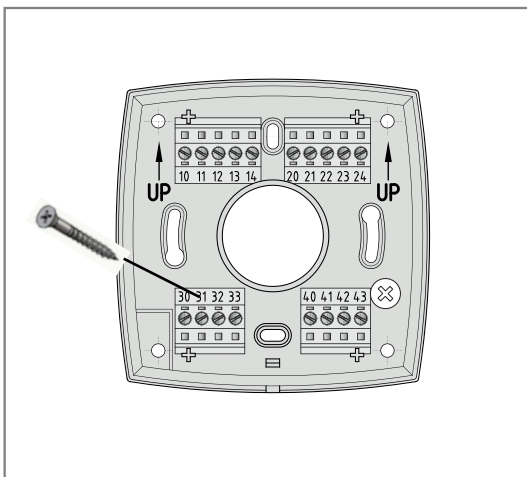

3. Mount the bottom plate on electrical box or directly on the wall.

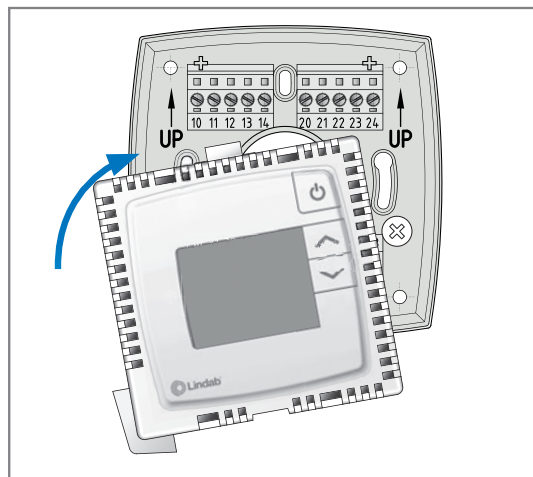

4. Remount in inverse arrangement when the plinths are connected. Notice that the front and bottom plate only can be fitted to each other in one way. See mark "UP".

How to connect the cables

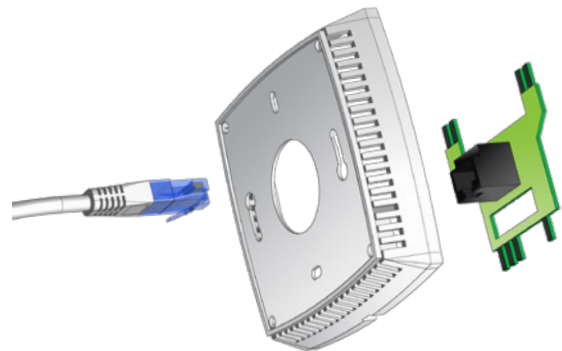
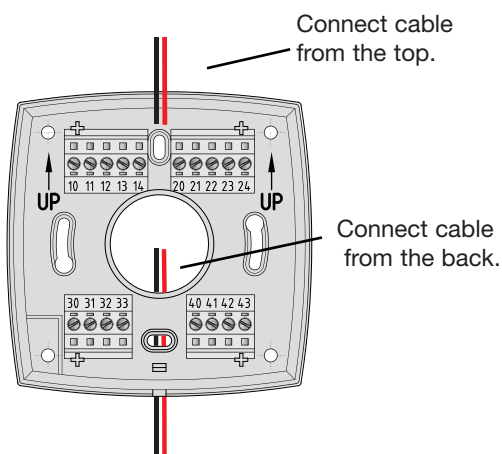

Connect net cable from the back.



Maintenance

Regula Combi is maintenance free. Use a damp cloth for cleaning the unit.

NB! Water should not come into the Regula Combi.

Regula Combi Installation

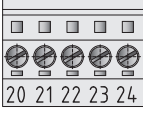
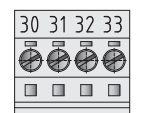
Electrical connections

Regula Combi connection terminals overview	
	<p>10 G+ Supply voltage 24 V A</p> <p>11 G0- Supply voltage 0 V</p> <p>12-14 No function.</p>
	<p>20 GDO 24 V AC out common for DO. Internally connected to terminal 10, G+.</p> <p>21 G0- 0 V common for UO. Internally connected to terminal 11, G0-.</p> <p>22 UO3 Control output forcing (cooling). For a 0-10 V DC actuator, max 5 mA. The actuator's 0-10 V control signal terminal is connected to terminal 22 and its supply terminals to terminals 20 and 21. Make sure that the reference pole G0- is connected to the correct terminal on the actuator. Alternatively for a 24 V AC thermal actuator, max 2.0 A. The thermal actuator is connected between terminals 22 and 20, GDO.</p> <p>23 UO1 Control output heating. For a 0-10 V DC actuator, max 5 mA. The actuator's 0-10 V control signal terminal is connected to terminal 23 and its supply terminals to terminals 20 and 21. Make sure that the reference pole G0 is connected to the correct terminal on the actuator. Alternatively for a 24 V AC thermal actuator, max 2.0 A. The thermal actuator is connected between terminals 23 and 20, GDO.</p> <p>24 UO2 Control output cooling. For a 0-10 V DC actuator, max 5 mA. The actuator's 0-10 V control signal terminal is connected to terminal 24 and its supply terminals to terminals 20 and 21. Make sure that the reference pole G0- is connected to the correct terminal on the actuator. Alternatively for a 24 V AC thermal actuator, max 2.0 A. The thermal actuator is connected between terminals 24 and 20, GDO.</p>
	<p>30 AI1 For temperature sensor, PT1000. Measuring range 0-50°C. The sensor is connected between terminals 30 and 41, AGnd.</p> <p>31 AI2 For a 0-10 V CO₂ sensor. Alternatively for a 0-10 V Damper position.</p> <p>32 DI1 Presence sensor. A potential-free contact is connected between terminals 32 and 40, +C. Alternatively for a Window contact.</p> <p>33 DI2/CI Condensation detector. The sensor is connected between terminals 33 and 41, AGnd. Alternatively for a Change Over indicator, CO₂ Relay sensor or CO₂ Pulse sensor.</p>
	<p>40 +C 24 V DC out common for DI</p> <p>41 AGnd Analogue ground, reference for AI</p> <p>42 A RS485-communication</p> <p>43 B RS485-communication B</p>

Connecting actuators

The maximum number of actuators that can be connected to the digital output (ON/OFF) is 10 for cooling and heating, respectively. When more than 4 on/off actuators for cooling or heating are connected, terminal blocks 10 and 20 must be connected with a cable because the Regula Combi print card can not handle the output power for more than 4 on/off actuators.

Set program on Regula Combi

To enter the parameter menu and change program the following steps should be followed:

1. Simultaneously hold the INCREASE and DECREASE buttons depressed for about 5 seconds
2. The Service indication will be displayed.
3. Then press the INCREASE button twice.
4. The display will now show the parameter number 0 (which chooses program).
5. Press the Occupancy button to select the desired parameter.
6. The parameter number will be replaced by the parameter value.

7. The value can be changed using the INCREASE and DECREASE buttons.
8. To retrieve the original value, i.e. the value before change, press the INCREASE and DECREASE buttons at the same time. The original value is shown on the display.
9. To acknowledge and store a set parameter value, press the Occupancy button again, the display then returns to showing the parameter number.

After a certain time, about 1 minute, or when the INCREASE and DECREASE buttons are pressed at the same time while in the menu, the display returns to the normal view. Exit is shown on the display after the last parameter. The parameter menu is exited by pressing the Occupancy button while in Exit.

Display handling

