

Lindab **FRU**

Installation instruction - UK
Asennusohje - FI
Montageanleitung - DE
Istruzioni di montaggio - IT
Instructions de montage - FR



Installation instruction

FRU

Product
Tuote
Produkt
Prodotto
Produit



Dimensions
Mitat
Maße
Dimensioni
Dimensions

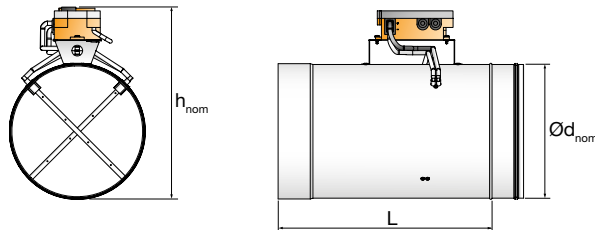

Dimension table

Ød_{nom}	L	h_{nom}	Weight
100	300	205	1.6
125	300	230	1.8
160	300	265	2.1
200	300	305	2.4
250	400	355	3.7
315	400	420	4.5
400	400	507	6.6
500	510	607	9.3
630	560	737	12.4

Regulator type table

Type	Regulator
FRU-D	VRU-D3-BAC
FRU-M	VRU-M1-BAC

Installation instruction

FRU

FRU in details
 FRU yksityiskohtaisesti
 FRU im Detail
 FRU nei dettagli
 FRU en détails

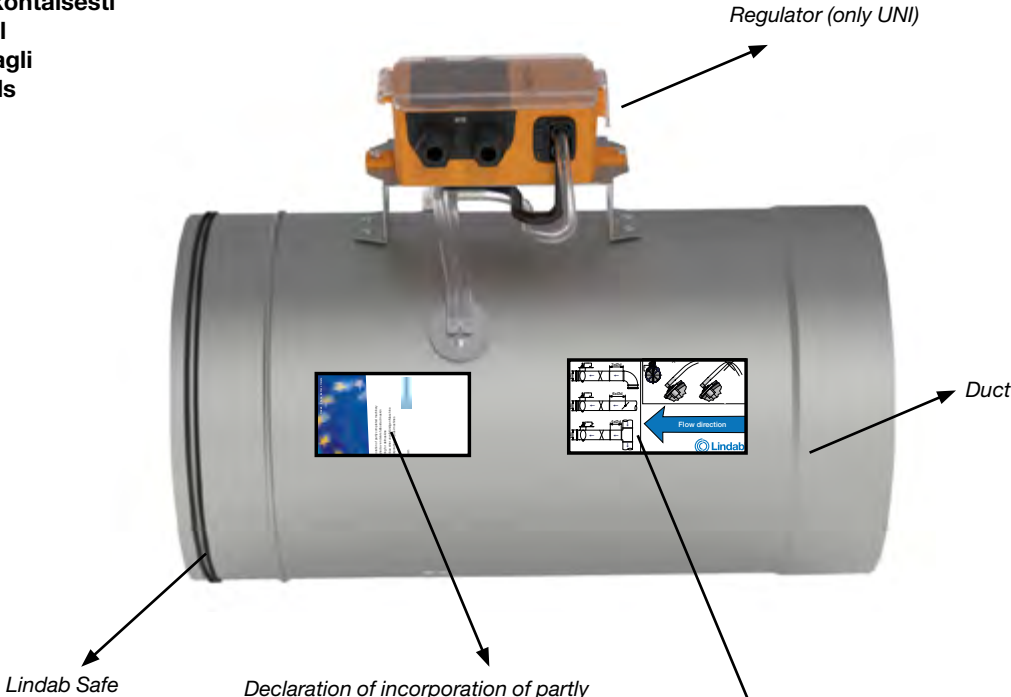

Declaration of incorporation of partly completed machinery leaflet



Label:

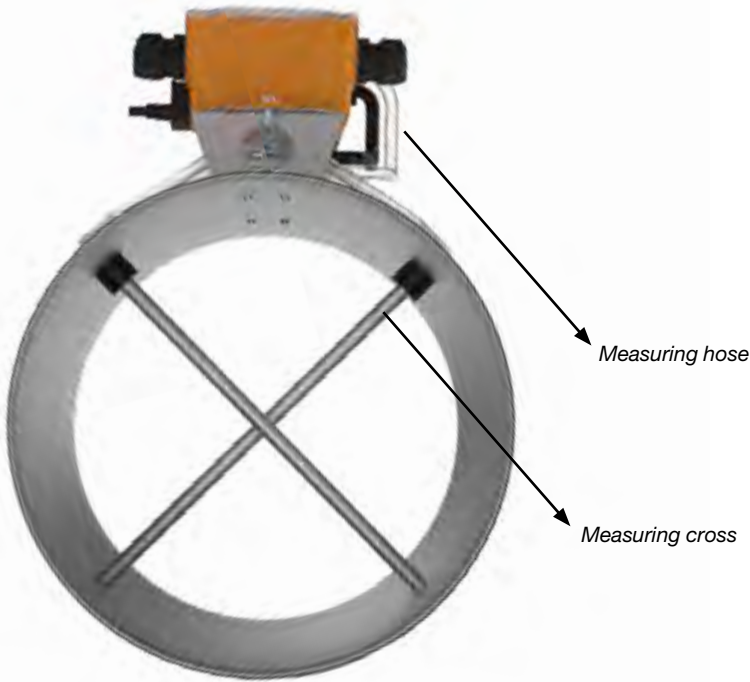
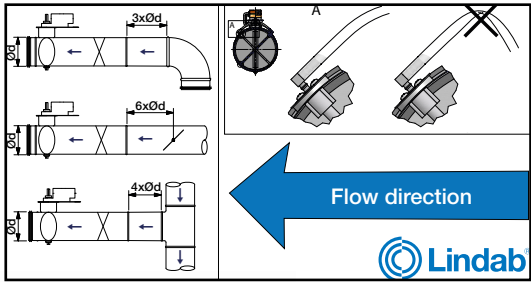

Installation instruction

FRU

Mounting of VRU
 Kannakointi VRU
 Montage des VRU
 Montaggio di VRU
 Montage de VRU



FRU is equipped with Lindab Safe for connection to the duct and is prepared for insulation up to 50 mm. FRU can be installed in any position without adjustment required. To avoid clogging of the measuring cross, it is recommended to use FRU only in applications with clean air, meaning free of dust, particles and similar.

Example:

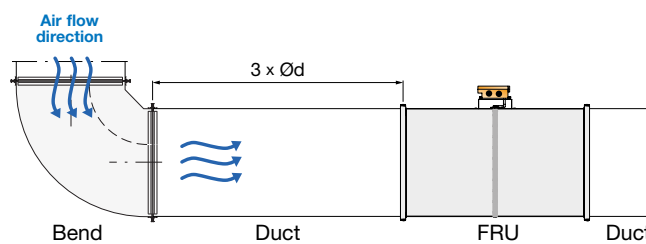

Example above showing top view of recommended straight duct distance between duct bend and a FRU.

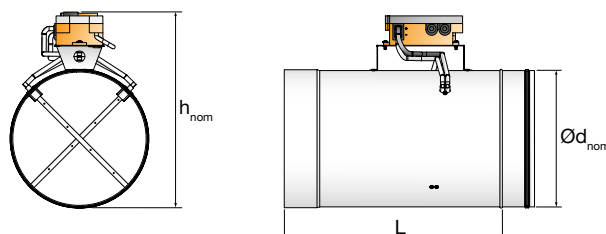

Front and top view of FRU and dimension Ød .

Installation instruction

FRU

Balancing
Säätöohjeet
Einregulierung
Bilanciamento
Réglage

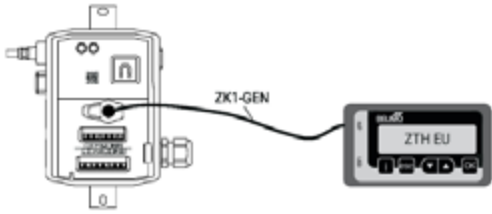
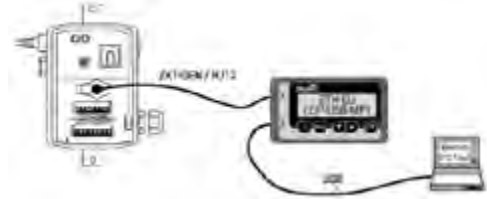
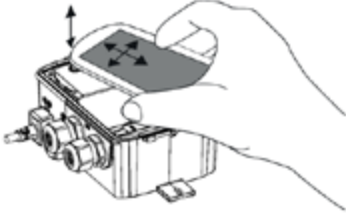
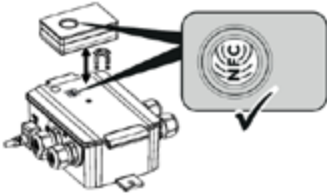
	<p style="text-align: center;">Universal controllers UNI(-M) / SPR(-M) / FAS(-M)</p> 
<p>Belimo Service Tool ZTH-EU</p>	
<p>Belimo PC-Tool MFT-P via ZTH-EU</p>	
<p>Belimo Assistant App with NFC</p>	
<p>Belimo Assistant App with Bluetooth via ZIP-BT-NFC</p>	
<p>Note *)</p>	<p>Modbus/Bacnet/KNX settings can be done with ZTH-EU, PC-Tool, or Belimo Assistant App.</p>
<p>Note **)</p>	<p>Belimo Assistant App works with all Universal controllers.</p>

Installation instruction

FRU

Maintenance:
Huolto
Wartung
Manutenzione
Entretien

Cleaning of measuring cross

The visible parts of the product can be wiped with a damp cloth. Remove pressure hoses and blow clean air into the aluminum pipes.

Do not blow into the plastic hoses mounted on the Belimo unit, as this can damage the flow/membrane sensors.

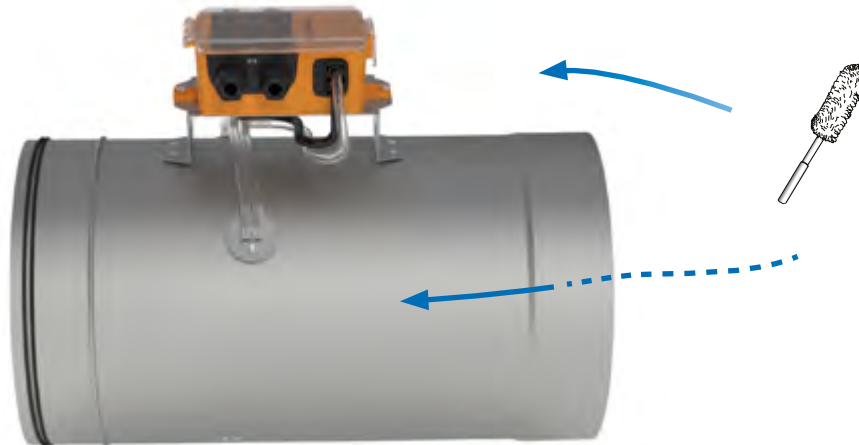

Cleaning the measuring cross

Please demount the hoses and use clean air to clean the hoses and measuring cross.

Mounting hoses

Put the hoses back followed by squeezing the black tightness rings back.



Mounting hoses step 1

Put the hoses back

Mounting hoses step 2

Squeeze the black tightness rings back.

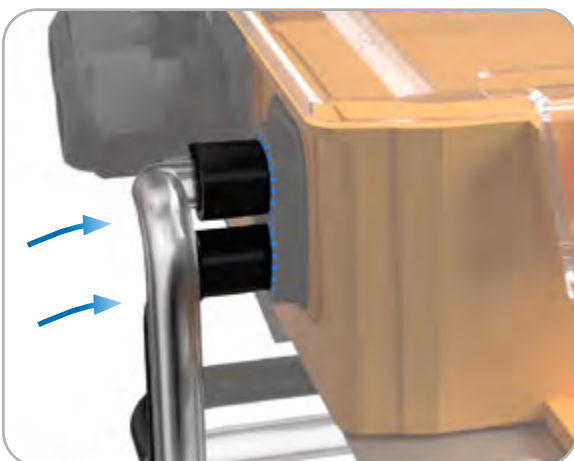



Most of us spend the majority of our time indoors. Indoor climate is crucial to how we feel, how productive we are and if we stay healthy.

We at Lindab have therefore made it our most important objective to contribute to an indoor climate that improves people's lives. We do this by developing energy-efficient ventilation solutions and durable building products. We also aim to contribute to a better climate for our planet by working in a way that is sustainable for both people and the environment.

Lindab | For a better climate