

Lindab **Dampers**

Assembly instructions

Dampers

DRU, DSU, DTU, DTHU, DTH1U, DTH2U, DTBU, DTBVU



DTBCU, DTFU, DTBLU, DSUSN, DSVUSN, DTPU, PSDRU, TDRU, TDSU



TASU, TATU, TATBU, LKSR



DAU, DA2EU, DAVU, CARU, CAR, MBU, MBFU



Dampers

FMU, FMDRU, FMDU, DIRU, DIRBU, DIRVU



FTCU, FTMU



Dampers

DRU, DSU, DTU, DTHU, DTH1U, DTH2U, DTBU, DTBVU, DTBCU, DTFU, DTBLU, DSUSN, DSVUSN, DTPU, PSDRU, TDRU, TDSU, TASU, TATU, TATBU

Assembly

In order to fulfil the requirements for air-tightness class D, the dampers must be installed as per 'Assembly Instruction Lindab Safe'.

For certain manual dampers, there is the option of adding a motor later on.

The dampers allow 50 mm duct insulation without the knob being hidden. For 100 mm duct insulation, there is an insulation cup, IK, for DRU, DSU, DTU, TASU and TATU.

PSDRU, TDRU and TDSU

The dampers are installed by inserting the two guide pins on the T-piece or saddle into the L-shaped slots on the dampers. The dampers are then locked by turning them slightly clockwise.

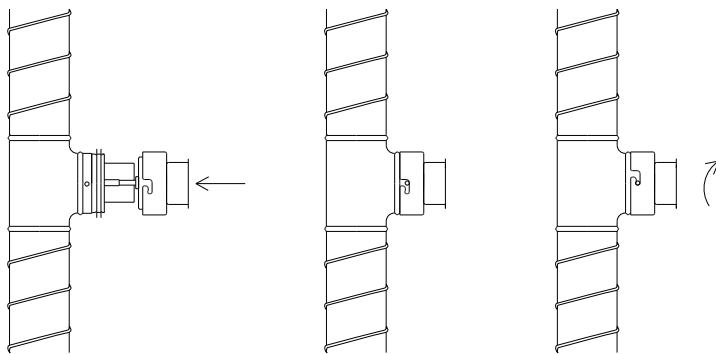

Balancing

On DRU, PSDRU and TDRU the damper blade is stepless adjustable through 0–90° (0°=fully open, 90°=completely closed) using the knob in the cup. Locking is performed using screws for Pozidrive (PZD2) and the damper angle can be read off a stamped grade on the edge of the cup. Other types of damper normally only work in the fully open or completely closed positions.

On motorized shut-off dampers and dampers adapted for a motor, the shaft end for the motor is equipped with a notch showing the position of the damper blade.

Manual dampers $\varnothing < 355$ can be supplemented with a sturdy handle to facilitate adjustment. Larger dimensions are equipped with a handle as standard.

Maintenance

Dampers and motors normally don't require any maintenance.

CE marking

Our dampers with electrical actuator are regarded as a component in the duct system and does not need to be CE marked separately.

Their electrical actuators on the other hand are part of the electrical system and are CE marked. Declaration of compliance with the essential requirements can be found at www.belimo.ch.

Dampers

| | |
|---------------------------------|--|
| Power supply..... | CM 24 / CM 24 F AC 19,2–28,8 V, 50/60 Hz DC 19,2–28,8 V |
| Power consumption | 0,5 W |
| For wire sizing | 1 VA |
| Connection | Cable 1 m, 3x0,75 mm ² |
| Operating angle..... | Continuously rotating |
| Torque at rated voltage..... | Min. 2 Nm |
| Direction of rotation..... | -L or -R |
| Position indication..... | Mechanical, removable |
| Running time for 95° | 75 s |
| Sound power level..... | Max. 35 dB (A) |
| Protection class..... | III Safety extra-low voltage |
| Protection type | IP 54 |
| Ambient temperature range | -30 to +50°C |
| Ambient moisture | 95 % RF |

| | |
|---------------------------------|---|
| Power supply..... | CM 230 / CM 230 F AC 65–265 V, 50/60 Hz |
| Power consumption | 1,5 W |
| For wire sizing | 3 VA |
| Connection | Cable 1 m, 3x0,75 mm ² |
| Operating angle..... | Max. 95°, adjustable 0–100% |
| Torque at rated voltage..... | Min. 2 Nm |
| Direction of rotation..... | -L or -R |
| Position indication..... | Mechanical, removable |
| Running time for 95° | 75 s |
| Sound power level..... | Max. 35 dB (A) |
| Protection class..... | II Safety insulated |
| Protection type | IP 54 |
| Ambient temperature range | -30 to +50°C |
| Ambient moisture | 95 % RF |

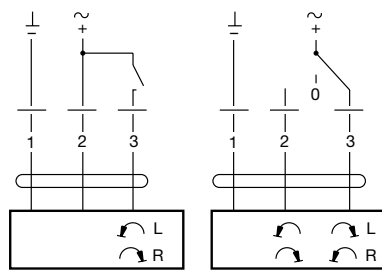

| | |
|---------------------------------|---|
| Power supply..... | CM 24 SR AC 24 V, 50/60 Hz DC 24 V |
| Power consumption | 0,5 W |
| For wire sizing | 2 VA |
| Connection | Cable 1 m, 4x0,75 mm ² |
| Torque at rated voltage..... | Min. 2 Nm |
| Direction of rotation..... | Switch selectable 0 or 1 |
| Running time for 95° | 75 s |
| Sound power level..... | Max. 35 dB (A) |
| Protection class..... | III Safety extra-low voltage |
| Protection type | IP 54 |
| Ambient temperature range | -30 to +50°C |
| Ambient moisture | 95 % RH |

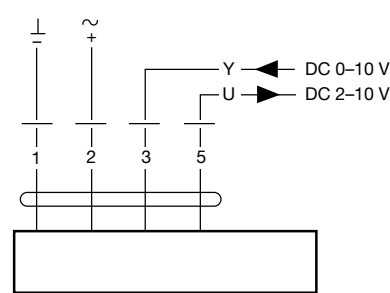

| | |
|---------------------------------|--|
| Power supply..... | LM 24 A-F AC 19,2–28,8 V, 50/60 Hz DC 19,2–28,8 V |
| Power consumption | 1 W |
| For wire sizing | 2 VA |
| Connection | Cable 1 m, 3x0,75 mm ² |
| Operating angle..... | Max. 95°, adjustable 0–100% |
| Torque at rated voltage..... | Min. 5 Nm |
| Direction of rotation..... | Switch selectable 0 or 1 |
| Position indication..... | Mechanical |
| Running time for 95° | 150 s |
| Sound power level..... | Max. 35 dB (A) |
| Protection class..... | III Safety extra-low voltage |
| Protection type | IP 54 |
| Ambient temperature range | -30 to +50°C |
| Ambient moisture | 95 % RH |

| | |
|---------------------------------|--|
| Power supply..... | LM 230 A-F AC 65–265 V, 50/60 Hz |
| Power consumption | 1,5 W |
| For wire sizing | 4 VA |
| Connection | Cable 1 m, 3x0,75 mm ² |
| Operating angle..... | Max. 95°, adjustable 0–100% |
| Torque at rated voltage..... | Min. 5 Nm |
| Direction of rotation..... | Switch selectable 0 or 1 |
| Position indication..... | Mechanical |
| Running time for 95° | 150 s |
| Sound power level..... | Max. 35 dB (A) |
| Protection class..... | II Safety insulated |
| Protection type | IP 54 |
| Ambient temperature range | -30 to +50°C |
| Ambient moisture | 95 % RH |

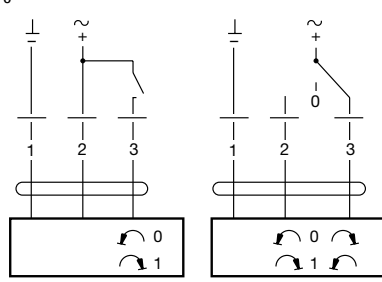

Dampers

| | | |
|---------------------------------|-----------------------------------|-----------------------------------|
| | LMQ 24A | LMQ-SR 24A |
| Power supply..... | AC 19,2-28,8 V, 50/60 Hz | AC 19,2-28,8 V, 50/60 Hz |
| | DC 21,6-28,8 V | DC 21,6-28,8 V |
| Power consumption | 13 W | 12 W |
| For wire sizing | 23 VA | 23 VA |
| Connection | Cable 1 m, 3x0,75 mm ² | Cable 1 m, 4x0,75 mm ² |
| Operating angle..... | Max. 95°, adjustable 0-100 % | Max. 95°, adjustable 0-100 % |
| Torque at rated voltage..... | Min. 4 Nm | Min. 4 Nm |
| Direction of rotation..... | Switch selectable 0 ↺ or 1 ↻ | Switch selectable 0 ↺ or 1 ↻ |
| Position indication | Mechanical | Mechanical |
| Running time for 90° | 2,5 s | 2,5 s |
| Sound power level..... | 52 dB (A) | 52 dB (A) |
| Protection class..... | III Safety extra-low voltage | II Safety insulated |
| Protection type | IP 54 | IP 54 |
| Ambient temperature range | -30 to +40°C | -30 to +40°C |
| Ambient moisture | 95 % RH | 95 % RH |

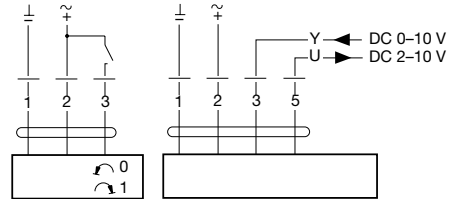

| | | |
|---------------------------------|-----------------------------------|-----------------------------------|
| | LM 24 A-SR | LM 230 A-SR |
| Power supply..... | AC 19,2-28,8 V, 50/60 Hz | AC 230 V, 50/60 Hz |
| | DC 19,2-28,8 V | |
| Power consumption | 1 W | 1,8 W |
| For wire sizing | 2 VA | 4 VA |
| Connection | Cable 1 m, 4x0,75 mm ² | Cable 1 m, 2x0,75 mm ² |
| Operating angle..... | Max. 95°, adjustable | Max. 95°, adjustable |
| Torque at rated voltage..... | Min. 5 Nm | Min. 5 Nm |
| Direction of rotation..... | Switch selectable 0 ↺ or 1 ↻ | Switch selectable 0 ↺ or 1 ↻ |
| Position indication | Mechanical | Mechanical |
| Running time for 95° | 150 s | 150 s |
| Sound power level..... | 35 dB (A) | 35 dB (A) |
| Protection class..... | III Safety extra-low voltage | II |
| Protection type | IP 54 | IP 54 |
| Ambient temperature range | -30 to +50°C | -30 to +50°C |
| Ambient moisture | 95 % RH | 95 % RH |

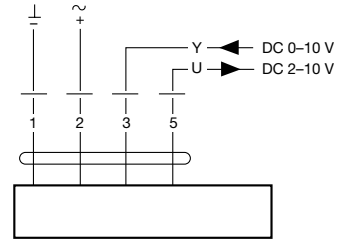

| | |
|---------------------------------|-----------------------------------|
| | LM 24 A-SX |
| Power supply..... | AC 19,2-28,8 V, 50/60 Hz |
| DC 21,6-28,8 V | |
| Power consumption | 2 W |
| For wire sizing | 4 VA |
| Connection | Cable 1 m, 4x0,75 mm ² |
| Operating angle..... | Max. 95°, adjustable 0-100 % |
| Torque at nominal voltage | Min. 5 Nm |
| Direction of rotation..... | Switch selectable 0/1 |
| Position at Y=0 V..... | Switch selectable 0 ↺ or 1 ↻ |
| Position indication | Mechanical |
| Running time for 90° | 150 s |
| Sound power level..... | 35 dB (A) |
| Protection class..... | III Safety extra-low voltage |
| Protection type | IP 54 |
| Ambient temperature range | -30 to +50 °C |
| Ambient humidity | 95 % RH |

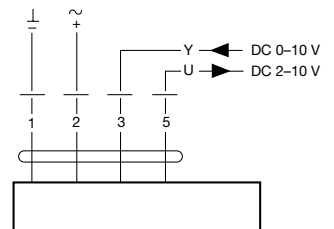

Dampers

| | | |
|---------------------------------|--|-----------------------------------|
| | NM 24 A-F | NM 230 A-F |
| Power supply..... | AC 19,2–28,8 V, 50/60 Hz DC 19,2–28,8 V | AC 85–265 V, 50/60 Hz |
| Power consumption | 1,5 W | 2,5 W |
| For wire sizing | 3,5 VA | 6 VA |
| Connection | Cable 1 m, 3x0,75 mm ² | Cable 1 m, 3x0,75 mm ² |
| Operating angle..... | Max. 95°, adjustable 0–100% | Max. 95°, adjustable 0–100 % |
| Torque at rated voltage..... | Min. 10 Nm | Min. 10 Nm |
| Direction of rotation..... | Switch selectable 0 ↺ or 1 ↻ | Switch selectable 0 ↺ or 1 ↻ |
| Position indication..... | Mechanical | Mechanical |
| Running time for 95° | 150 s | 150 s |
| Sound power level..... | Max. 35 dB (A) | Max. 35 dB (A) |
| Protection class..... | III Safety extra-low voltage | II Safety insulated |
| Protection type | IP 54 | IP 54 |
| Ambient temperature range | -30 to +50°C | -30 to +50°C |
| Ambient moisture | 95 % RH | 95 % RH |

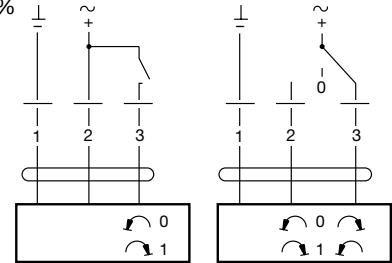

| | | |
|---------------------------------|--|-----------------------------------|
| | SM 24 A | SM 230 A |
| Power supply..... | AC 19,2–28,8 V, 50/60 Hz DC 19,2–28,8 V | AC 85–265 V, 50/60 Hz |
| Power consumption | 2 W | 2,5 W |
| For wire sizing | 4 VA | 6 VA |
| Connection | Cable 1 m, 3x0,75 mm ² | Cable 1 m, 3x0,75 mm ² |
| Operating angle..... | Max. 95°, adjustable 0–100% | Max. 95°, adjustable 0–100% |
| Torque at rated voltage..... | Min. 20 Nm | Min. 20 Nm |
| Direction of rotation..... | Switch selectable 0 ↺ or 1 ↻ | Switch selectable 0 ↺ or 1 ↻ |
| Position indication..... | Mechanical | Mechanical |
| Running time for 95° | 150 s | 150 s |
| Sound power level..... | Max. 35 dB (A) | Max. 35 dB (A) |
| Protection class..... | III Safety extra-low voltage | II Safety insulated |
| Protection type | IP 54 | IP 54 |
| Ambient temperature range | -30 to +50°C | -30 to +50°C |
| Ambient moisture | 95 % RH | 95 % RH |

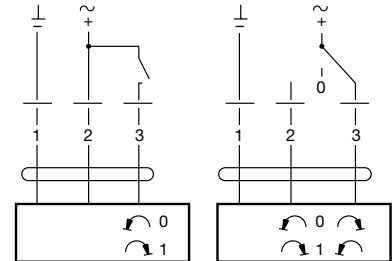

| | | |
|---------------------------------|--|-----------------------------------|
| | GM 24 A | GM 230 A |
| Power supply..... | AC 19,2–28,8 V, 50/60 Hz DC 19,2–28,8 V | AC 85–265 V, 50/60 Hz |
| Power consumption | 4,5 W | 4,5 W |
| For wire sizing | 7 VA | 7 VA |
| Connection | Cable 1 m, 3x0,75 mm ² | Cable 1 m, 3x0,75 mm ² |
| Operating angle..... | Max. 95°, adjustable 0–100% | Max. 95°, adjustable 0–100% |
| Torque at rated voltage..... | Min. 40 Nm | Min. 40 Nm |
| Direction of rotation..... | Switch selectable 0 ↺ or 1 ↻ | Switch selectable 0 ↺ or 1 ↻ |
| Position indication..... | Mechanical | Mechanical |
| Running time for 95° | 150 s | 150 s |
| Sound power level..... | Max. 45 dB (A) | Max. 45 dB (A) |
| Protection class..... | III Safety extra-low voltage | II Safety insulated |
| Protection type | IP 54 | IP 54 |
| Ambient temperature range | -30 to +50°C | -30 to +50°C |
| Ambient moisture | 95 % RH | 95 % RH |

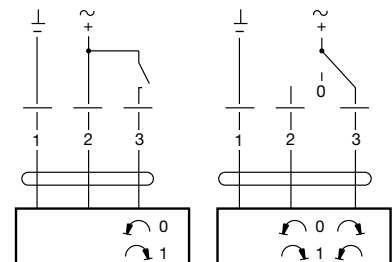

Dampers

| | TF 24 | TF 230 |
|-----------------------------------|---|-----------------------------------|
| Power supply..... | 2AC 19,2–28,8 V, 50/60 Hz DC 21,6–28,8 V | AC 85–265 V, 50/60 Hz |
| Power consumption | | |
| – during opening..... | 2,5 W | 2,5 W |
| – stand-by | 1,5 W | 1,5 W |
| For wire sizing | 5 VA | 5 VA |
| Connection | Cable 1 m, 2×0,75 mm ² | Cable 1 m, 2×0,75 mm ² |
| Operating angle, adjustable | Mech. limited to 95° | Mech. limited to 95° |
| Torque at rated voltage | | |
| – motor | Min. 2 Nm | Min. 2 Nm |
| – return spring | Min. 2 Nm | Min. 2 Nm |
| Direction of rotation..... | Optional through right or | Optional through right or |
| left-hand installation L/R | | left-hand installation L/R |
| Position indication | Mechanical | Mechanical |
| Running time | | |
| – motor | < 75 s (0–2 Nm) | < 75 s (0–2 Nm) |
| – return spring | < 25 s | < 25 s |
| Degree of protection..... | IP 42 | IP 42 |
| Ambient temperature range | -30 to +50°C | -30 to +50°C |

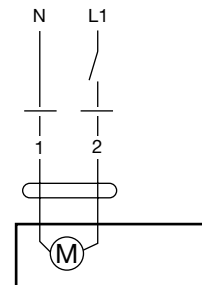

| | LF 24 | LF 230 |
|-----------------------------------|---|-----------------------------------|
| Power supply..... | 2AC 19,2–28,8 V, 50/60 Hz DC 21,6–28,8 V | AC 198–264 V, 50/60 Hz |
| Power consumption | | |
| – during opening..... | 5 W | 5 W |
| – stand-by | 2,5 W | 3 W |
| For wire sizing | 7 VA | 7 VA |
| Connection | Cable 1 m, 2×0,75 mm ² | Cable 1 m, 2×0,75 mm ² |
| Operating angle, adjustable | Mech. limited to 95° | Mech. limited to 95° |
| Torque at rated voltage | | |
| – motor | Min. 4 Nm | Min. 4 Nm |
| – return spring | Min. 4 Nm | Min. 4 Nm |
| Direction of rotation..... | Optional through right or | Optional through right or |
| left-hand installation L/R | | left-hand installation L/R |
| Position indication | Mechanical | Mechanical |
| Running time | | |
| – motor | 40–75 s (0–4 Nm) | 40–75 s (0–4 Nm) |
| – return spring | app. 20 s | app. 20 s |
| Sound power level | | |
| – motor | max 50 dB (A) | max 50 dB (A) |
| – return spring | app. 62 dB (A) | app. 62 dB (A) |
| Degree of protection..... | IP 54 | IP 54 |
| Ambient temperature range | -30 to +50°C | -30 to +50°C |

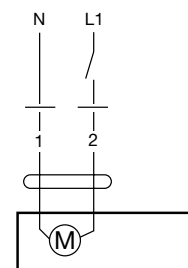

Dampers

| | | |
|-----------------------------------|---|--|
| | SFA (both 24 V and 230 V power supply) | |
| Power supply..... | AC 19,2–28,8 V, 50/60 Hz DC 21,6–137,5 V | |
| Power consumption | 7 W | |
| – during operation | 3,5 W | |
| – stand-by | 18 VA (I_{max} 20 A @ 5 ms) | |
| For wire sizing | Cable 1 m, 2×0,75 mm ² | |
| Connection | Mech. limited to 95° | |
| Operating angle, adjustable | Min. 20 Nm | |
| Torque at rated voltage | Min. 20 Nm | |
| – motor | Optional through right or left-hand installation L/R | |
| – spring bias | Mechanical | |
| Direction of rotation | Running time | |
| Position indication | – motor ≤ 75 s (0 ... 20 Nm) | |
| Running time | – return spring ≤ 20 s @ -20 ... 50°C / max. 60 s @ -30°C | |
| – motor | Sound power level | |
| – return spring | – motor ≤ 45 dB (A) | |
| – return spring | – return spring ≤ 62 dB (A) | |
| Degree of protection..... | IP 54 | |
| Ambient temperature range | -30 to +50 °C | |
| Ambient temperature range | -30 to +50 °C | |

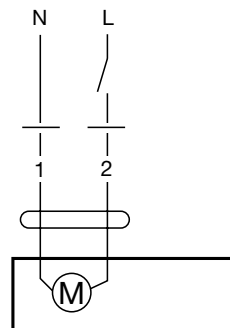

| | | |
|-----------------------------------|--|--|
| | EF 24A | EF 230A |
| Power supply..... | AC 19,2–28,8 V, 50/60 Hz DC 21,6–28,8 V | AC 90–264 V, 50/60 Hz |
| Power consumption | 9,5 W | 9 W |
| – during operation | 4,5 W | 4,5 W |
| – stand-by | 16 VA | 21 VA |
| For wire sizing | Cable 1 m, 2×0,75 mm ² | Cable 1 m, 2×0,75 mm ² |
| Connection | Mech. limited to 95° | Mech. limited to 95° |
| Operating angle, adjustable | Min. 30 Nm | Min. 30 Nm |
| Torque at rated voltage | Min. 30 Nm | Min. 30 Nm |
| – motor | Optional through right or left-hand installation L/R | Optional through right or left-hand installation L/R |
| – spring bias | Mechanical | Mechanical |
| Direction of rotation | Running time | Running time |
| Position indication | – motor ≤ 75 s (0–30 Nm) | – motor ≤ 75 s (0–30 Nm) |
| Running time | – return spring ≤ 20 s | – return spring ≤ 20 s |
| – motor | Sound power level | Sound power level |
| – return spring | – motor ≤ 55 dB (A) | – motor ≤ 55 dB (A) |
| – return spring | – return spring ≤ 71 dB (A) | – return spring ≤ 71 dB (A) |
| Degree of protection..... | IP 54 | IP 54 |
| Ambient temperature range | -30 to +50 °C | -30 to +50 °C |
| Ambient temperature range | -30 to +50 °C | -30 to +50 °C |

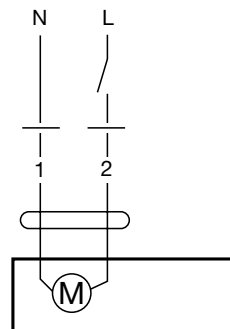

Dampers

LKSR

Assembly

In order to fulfil the requirements for air-tightness class C, the damper must be installed as per 'Assembly Instruction Rectangular air duct systems'.

For the damper, there is the option of adding a motor later on.

The damper allows a 50 mm duct insulation without the knob being hidden. For 100 mm insulation, an insulation cup, IK, is available.

Balancing

On LKSR the damper blade is adjusted through 0–90° (0° = fully open, 90° = completely closed) using the knob in the cup. Locking is performed using screws for Pozidrive (PZD2) and the damper angle can be read off a stamped grade on the edge of the cup.

Manual damper can be supplemented with a sturdy handle to facilitate adjustment.

Maintenance

The damper and motor normally don't require any maintenance.

Constant/variable flow dampers

DAU, DA2EU, DAVU

Assembly

In order to fulfil the requirements for air-tightness class D, the devices must be installed as per 'Assembly Instruction Lindab Safe'.

The devices must be installed with the air flow in the direction of the arrow.

The devices allow 50 mm duct insulation without the scale or any motor being hidden.

Pressure range

50–1000 Pa over the unit.

Interference sensitivity

In order to achieve stated precision for the set flow, a straight duct of at least $3 \times d$ before and $1.5 \times d$ after the devices is required. A assembly close to a source of interference (bend, saddle, etc.) reduces control accuracy and the flow can deviate from the set value.

Changes in direction

The units are independent of their direction of installation; you can deviate from the projected direction and install them in any direction you like without affecting accuracy.

Systematic error

Control accuracy

The devices are calibrated within their entire operating range at the factory. This means the devices keep the flow constant to within approx. ± 5 to ± 10 % of the set flow. Larger deviations occur at lower flows, especially with small sizes.

Maintenance

The devices normally don't require any maintenance, but should be protected from contaminated air wherever possible.

CE marking

Our dampers with electrical actuator are regarded as a component in the duct system and does not need to be CE marked separately.

Their electrical actuators on the other hand are part of the electrical system and are CE marked. Declaration of compliance with the essential requirements can be found at www.belimo.ch.

Constant/variable flow dampers

DAU

The flow is adjusted by loosening the central nut and using the knob to turn the scale arrow so that it points to the desired flow on the scale. The nut is then locked.

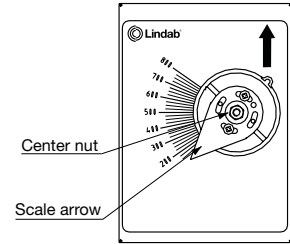

DA2EU

Setting of flows

The two flows are set by moving the end stops. At delivery the stops are set at largest possible distance. If you want to limit the flow span proceed in the following way:

1. The one flow is set by turning the spindle so that the scale arrow points at the desired flow and thereafter move one of the end stops close up to the clamp's one heel and lock the stop there.
2. The other flow is set by turning the spindle so that the scale arrow points at this flow and thereafter move the other end stop close up to the clamp's other heel and lock this stop there.

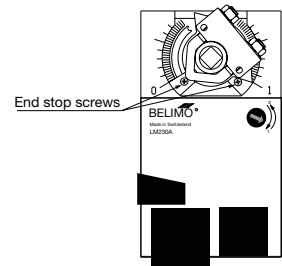

Choice of flows

The one flow is chosen by feeding an operating voltage. This voltage, 24 or 230 V, turns the motor to one of the stops.

The other flow is chosen by breaking the operating voltage. The motor then goes to the other stop.

Technical data for the motors

| | LM 24 A | LM 230 A |
|---------------------------------|--|-----------------------------------|
| Power supply..... | AC 19,2–28,8 V, 50/60 Hz DC 19,2–28,8 V | AC 65–265 V, 50/60 Hz |
| Power consumption | 1 W | 1,5 W |
| For wire sizing | 2 VA | 4 VA |
| Connection | Cable 1 m, 3x0,75 mm ² | Cable 1 m, 3x0,75 mm ² |
| Operating angle..... | Max. 95°, adjustable 0–100% | Max. 95°, adjustable 0–100% |
| Torque at rated voltage..... | Min. 5 Nm | Min. 5 Nm |
| Direction of rotation..... | Switch selectable 0 ↻ or 1 ↻ | Switch selectable 0 ↻ or 1 ↻ |
| Position indication..... | Mechanical | Mechanical |
| Running time for 95° | 150 s | 150 s |
| Sound power level..... | Max. 35 dB (A) | Max. 35 dB (A) |
| Protection class..... | III Safety extra-low voltage | II Safety insulated |
| Protection type | IP 54 | IP 54 |
| Ambient temperature range | -30 to +50°C | -30 to +50°C |
| Ambient moisture | 95 % RH | 95 % RH |

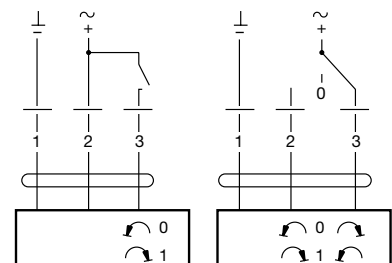

Constant/variable flow dampers

DAVU

Setting of flow limits

The two flow limits are set by moving the end stops. At delivery the stops are set at largest possible distance. If you want to limit the flow span proceed in the following way:

1. The one flow limit is set by turning the spindle so that the scale arrow points at the desired flow and thereafter move one of the end stops close up to the clamp's one heel and lock the stop there.
2. The other flow limit is set by turning the spindle so that the scale arrow points at this flow and thereafter move the other end stop close up to the clamp's other heel and lock this stop there.
3. The motor shall then be adapted so that the regulating span 2–10 V adapts to the thus set flow span. This is done by a push on the "gear disengagement" button. The motor then automatically performs a stroke between the flow limits.

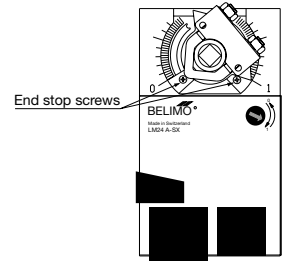

Choice of flow

The flow is chosen by feeding a control signal. This signal, 2–10 V, sets the motor in a proportional position between the flow limits.

Technical data for the motor

| | |
|---------------------------------|--|
| | LM 24 A-SX |
| Power supply..... | AC 19,2–28,8 V, 50/60 Hz DC 21,6–28,8 V |
| Power consumption | 2 W |
| For wire sizing | 4 VA |
| Connection | Cable 1 m, 4x0,75 mm ² |
| Operating angle | Max. 95°, adjustable 0–100 % |
| Torque at nominal voltage | Min. 5 Nm |
| Direction of rotation..... | Switch selectable 0/1 |
| Position at Y=0 V..... | Switch selectable 0 ↺ or 1 ↻ |
| Position indication..... | Mechanical |
| Running time for 90° | 150 s |
| Sound power level..... | 35 dB (A) |
| Protection class..... | III Safety extra-low voltage |
| Protection type | IP 54 |
| Ambient temperature range | -30 to +50 °C |
| Ambient humidity | 95 % RH |

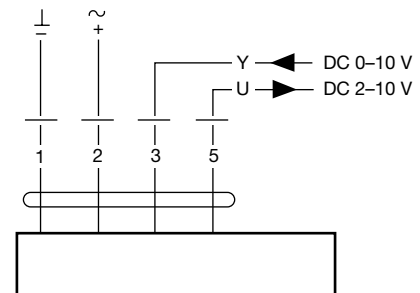

Air stream operated dampers

CARU, CAR

Assembly

CARU

In order to fulfil the requirements of tightness class D the damper must be installed as per 'Assembly Instruction Lindab Safe'.

CAR

The damper is installed by simply placing it inside a duct.

Measurement

The dampers normally don't need any maintenance.

Measuring bends

MBU, MBFU

Assembly

In order to fulfil the requirements for air-tightness class D, the bends must be installed as per 'Assembly Instruction Lindab Safe'.

The bends allow 50 mm duct insulation without the measuring points being hidden. For 100 mm insulation, an insulation cup, IK, is available.

Measurement

By measuring the pressure difference Δp in Pa at the measuring points, you can achieve a flow q in l/s using the equation on the devices.

The specified flows only apply for air with a density of 1.2 kg/m³. For air of another density (ρ_{other}) the flow ($q_{\text{other_density}}$) is achieved as per the formula:

$$q_{\text{other_density}} = q_{\text{equation}} \times \sqrt{\frac{1,2}{\rho_{\text{other}}}}$$

| Device | Dimension mm | k-factor |
|--------|--------------|----------|
| MBU | 100 | 6.85 |
| | 125 | 10.3 |
| | 160 | 17.0 |
| | 200 | 26.3 |
| | 250 | 41.7 |
| MBFU | 315 | 65.0 |
| | 400 | 115 |
| | 500 | 179 |
| | 630 | 283 |

Systematic error

Straight stretches are required in order to achieve flows as per equations with specified accuracy. The systematic error m_2 is 5% and 10% below the minimum requirements for straight stretches as specified.

Maintenance

The measuring bends normally don't require any maintenance.

Cleaning

The device does not limit cleaning opportunities.

Flow meters

FMU, FMDRU

Assembly

In order to fulfil the requirements for air-tightness class D, the devices must be installed as per 'Assembly Instruction Lindab Safe'.

FMDRU must be installed with the air flow in the direction of the arrow.

The devices allow 100 mm duct insulation without sticker or measuring points being hidden. The cup around FMDRU's damper knob allows 50 mm duct insulation without the knob being hidden. For 100 mm insulation, an insulation cup, IK, is available.

For optimum readability (regardless of the installation position), the plate with the sticker can be turned, folded up to prevent it disappearing in any insulation or to be easily removed and positioned separately from the device.

Measurement

By measuring the pressure difference Δp in Pa at the measuring points, you can achieve a flow q in l/s using the equation on the devices.

With FMDRU you can set the desired flow, as the damper blade is adjustable through 0–90° (0°=fully open, 90°=completely closed) using the knob in the cup. Locking is performed using screws for Pozidrive (PZD2) and the damper angle can be read off a stamped grade on the edge of the cup.

The specified flows only apply for air with a density of 1.2 kg/m³. For air of another density (ρ_{other}) the flow ($q_{\text{other_density}}$) is achieved as per the formula:

$$q_{\text{other_density}} = q_{\text{equation}} \times \sqrt{\frac{1,2}{\rho_{\text{other}}}}$$

| Dimension mm | k-factor |
|--------------|----------|
| 80–63 | 4,40 |
| 100–80 | 7,32 |
| 125–100 | 11,2 |
| 160–125 | 18,0 |
| 200–160 | 29,4 |
| 250–200 | 45,7 |
| 315–250 | 73,3 |
| 400–315 | 116 |
| 500–400 | 191 |
| 630–500 | 283 |

Systematic error

Straight stretches are required in order to achieve flows as per equations with specified accuracy. The systematic error m_2 is 5% and 10% below the minimum requirements for straight stretches as specified. For these minimum straight requirements – do not install measuring points in line with the nearest bend's inside radius.

Maintenance

The devices normally don't require any maintenance.

Cleaning

FMU does not limit cleaning opportunities.

Flow meters

FMDU

Assembly

In order to fulfil the requirements for air-tightness class D, the device must be installed as per 'Assembly Instruction Lindab Safe'.

The device must be installed with the air flow in the direction of the arrow.

The device allows 50 mm duct insulation without sticker or measuring points being hidden.

The cup around the damper knob allows 50 mm duct insulation without the knob being hidden. For 100 mm insulation, an insulation cup, IK, is available.

For optimum readability (regardless of the installation position), the plate with the sticker can be turned or easily removed and positioned separately from the device.

Measurement

By measuring the pressure difference Δp in Pa at the measuring points, you can achieve a flow q in l/s using the equation on the device.

You can set the desired flow, as the damper blade is adjustable through 0–90° (0°=fully open, 90°=completely closed) using the knob in the cup. Locking is performed using screws for Pozidrive (PZD2) and the damper angle can be read off a stamped grade on the edge of the cup.

The specified flows only apply for air with a density of 1.2 kg/m³. For air of another density (ρ_{other}) the flow ($q_{\text{other_density}}$) is achieved as per the formula:

$$q_{\text{other_density}} = q_{\text{equation}} \times \sqrt{\frac{1,2}{\rho_{\text{other}}}}$$

| Dimension mm | k-factor | Colour coding for measuring points |
|--------------|----------|------------------------------------|
| 80 | 2.99 | transparent |
| 100 | 4.90 | red |
| 125 | 7.95 | green |
| 160 | 13.8 | yellow |
| 200 | 21.3 | blue |
| 250 | 34.6 | black |
| 315 | 57.8 | white |
| 400 | 88.8 | transparent |
| 500 | 146 | red |
| 630 | 234 | green |

Systematic error

Straight stretches are required in order to achieve flows as per equations with specified accuracy. The systematic error m_2 is 5% and 10% below the minimum requirements for straight stretches as specified.

Maintenance

The device normally doesn't requires any maintenance.

Damper with flow meter

DIRU

Assembly

Mount the dampers according to “Assembly Instructions Lindab Safe” to meet with the requirements for tightness class C.

Consider required straight distance after or before disturbance, as mentioned on the card attached to the measurement nozzles, to obtain accurate flow measurement. Dampers with dimension 400, 500 and 630 are provided with transport protections. Remove these before assembly.

The damper may not be loaded with weight from connected ducts, specially when assembled vertically.

Measuring

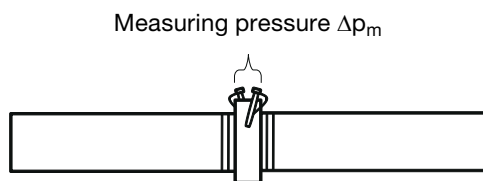

The balancing graphs show the flow, q , as a function of the measured pressure, Δp_m , in the measure nozzles.

$$q = k \cdot \sqrt{\Delta p_m}$$

The formula is only accurate for air with the density 1,2 kg/m³. For air with other density, (ρ_{other}), the flow, (q_{other}), is given according to the formula.

$$q_{\text{other}} = q_{\text{equation}} \times \sqrt{\frac{1,2}{\rho_{\text{other}}}}$$

The balancing graphs should only be used to balance the system. They should not be used to calculate the pressure drop in the system, in those cases the dimensioning graphs should be used.

Measurement accuracy

Consider required straight distance after or before disturbance, as mentioned on the card attached to the measurement nozzles, to obtain accurate flow measurement.

Balancing

Connect the measuring hoses to the damper measuring nozzles.

Loosen the locking screws (3), which have Philips slot no.1. adjust the handle so that requisited pressure drop receives. Fasten the screws (3) and remount the tightness screws (2), so that the slot gets airtight.

For dimension 400,500 and 630 - remove the tightness screws (2). Then loosen the locking screws (3), which have Philips slot no. 2. Adjust the handle so that requisited pressure drop receives. Fasten the screws (3) and remount the tightness screws (2), so that the slot gets airtight.

Disconnect the hoses and plug the nozzles.

Maintenance

The product normally doesn't requires any maintenance.

Cleaning

By fully open the damper, one get access to the duct. Do not forget to readjust the damper after cleaning.

Damper with flow meter

DIRU, DIRBU, DIRVU

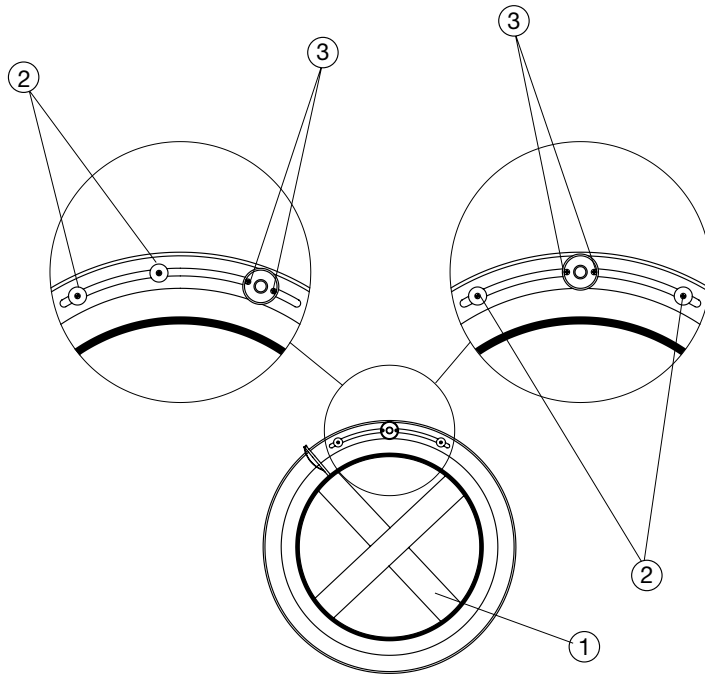

To set the air flow:

1. Determine the k factor on the scale on the damper, k.
2. Measure the pressure difference by connecting a measuring device to the damper's nozzles, Δp_m .
3. Calculate the flow by using the formula, $q = k \cdot \sqrt{\Delta p_m}$.
4. Compare the calculated flow to the required.
5. Adjust the damper if necessary and repeat steps 1-4 until you get the required flow.

Don't forget to plug the nozzles after measuring.

Damper with flow meter

DIRU, DIRBU, DIRVU

Pressure drop graphs with noise generation for dimensioning

The dimensioning graphs show the pressure drop over the damper with flow meter, Δp_t . They should be used to determine the pressure drop and to provide information about sound power levels at different settings.

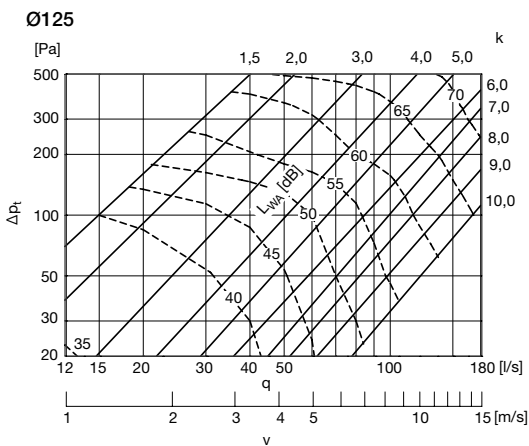
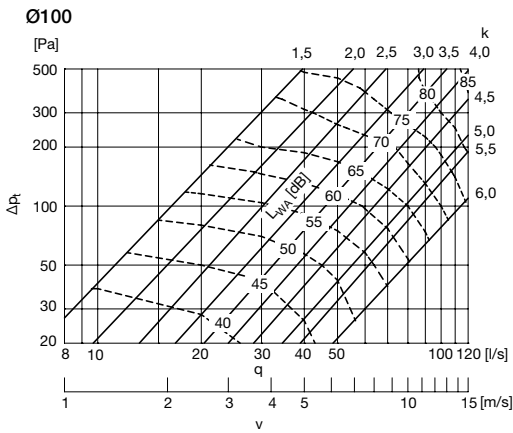
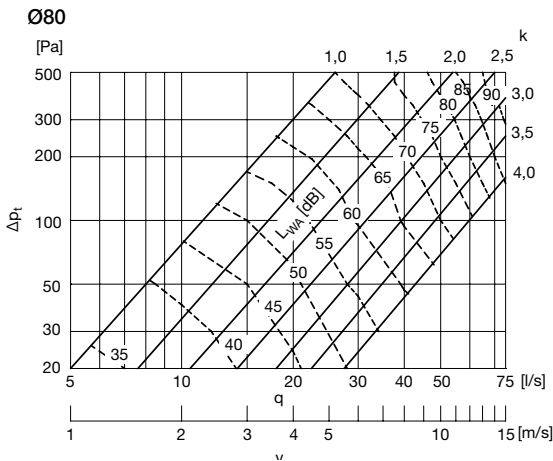

Flow graphs for balancing

The balancing graphs show the flow as a function of the measured pressure, Δp_m . These graphs should be used to balance the system.

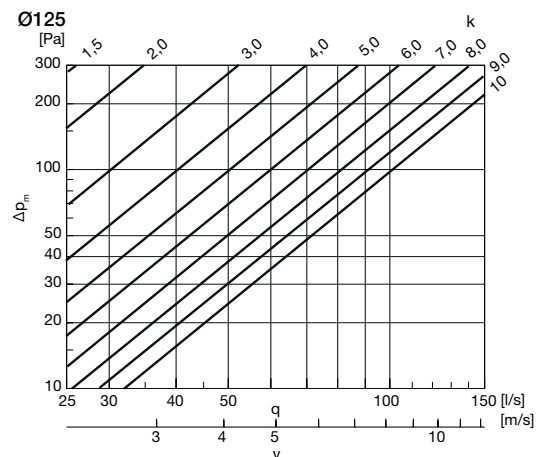
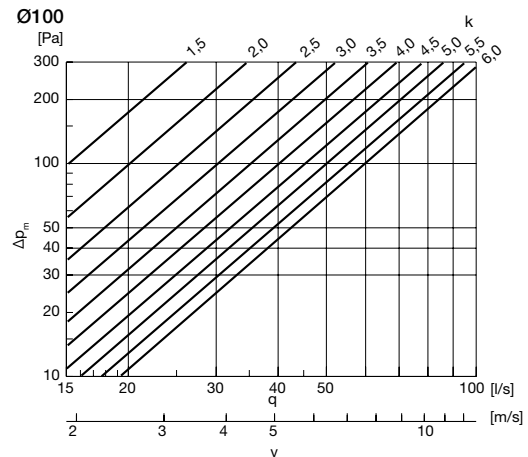
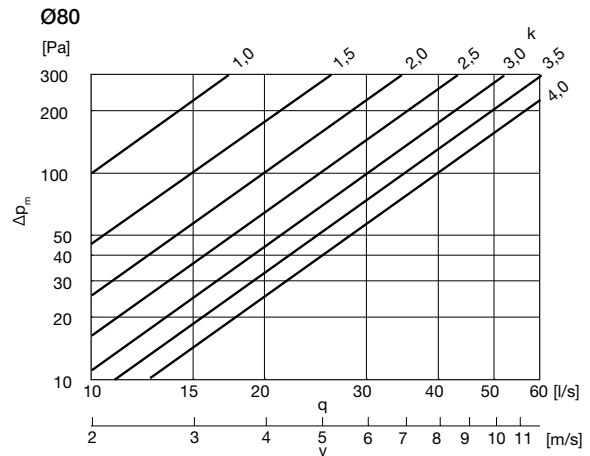

Damper with flow meter

DIRU, DIRBU, DIRVU

Pressure drop graphs with noise generation for dimensioning

Flow graphs for balancing

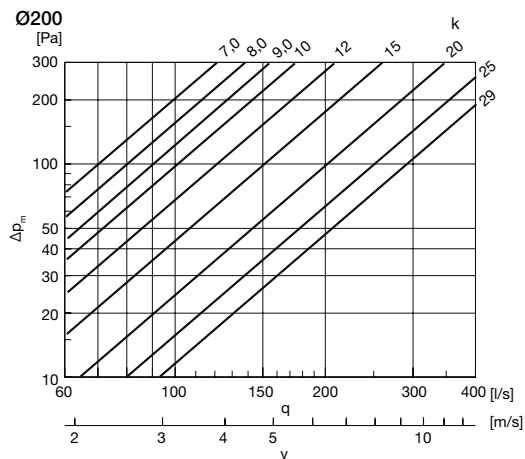
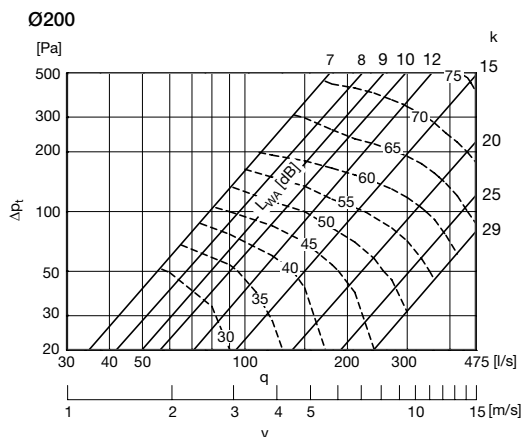
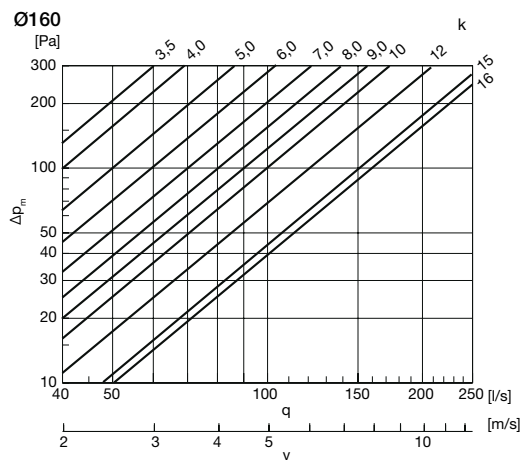
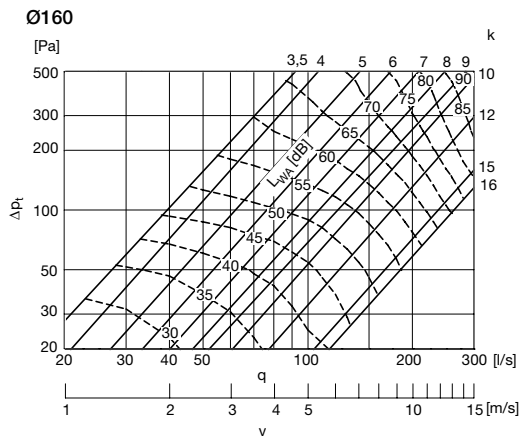
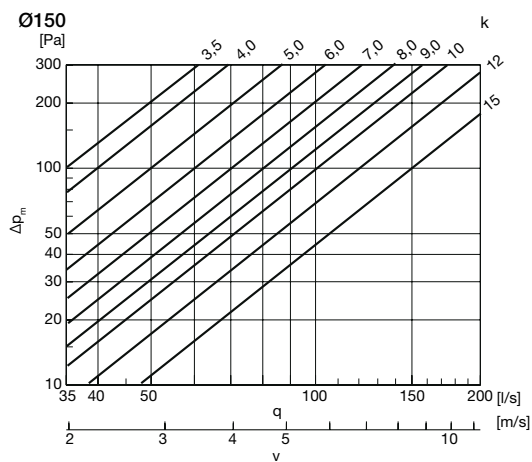
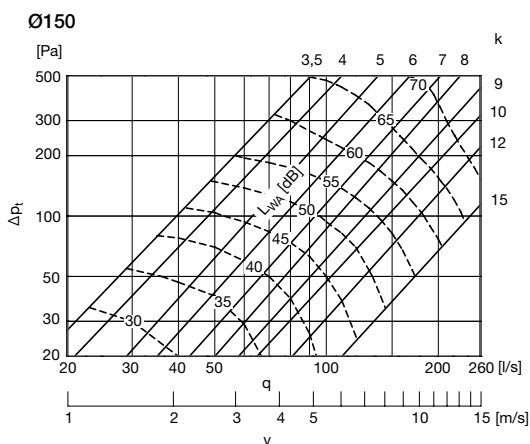

Damper with flow meter

DIRU, DIRBU, DIRVU

Pressure drop graphs with noise generation for dimensioning

Flow graphs for balancing

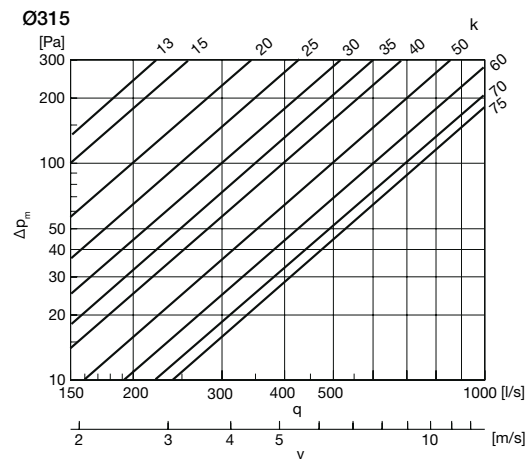
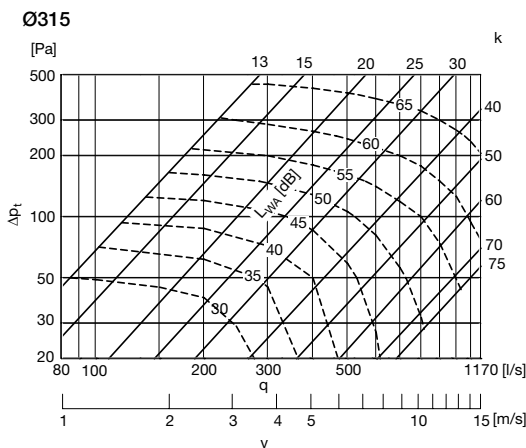
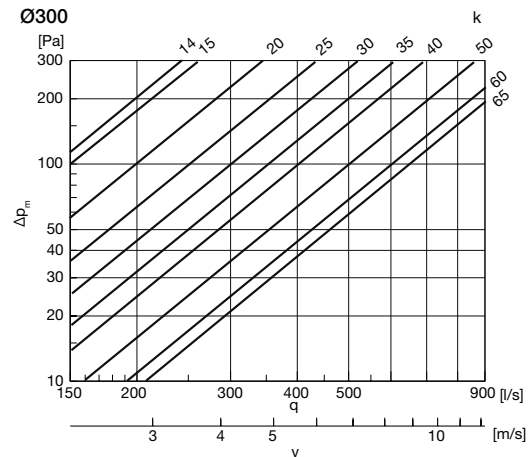
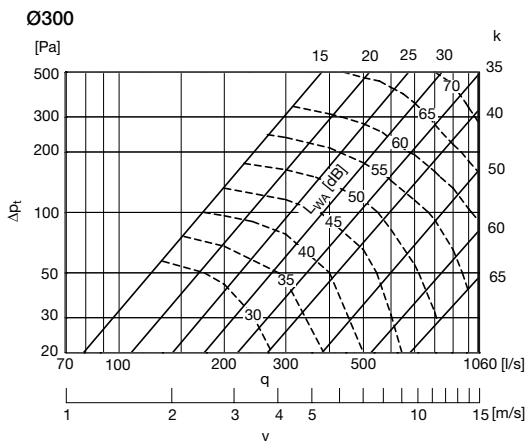
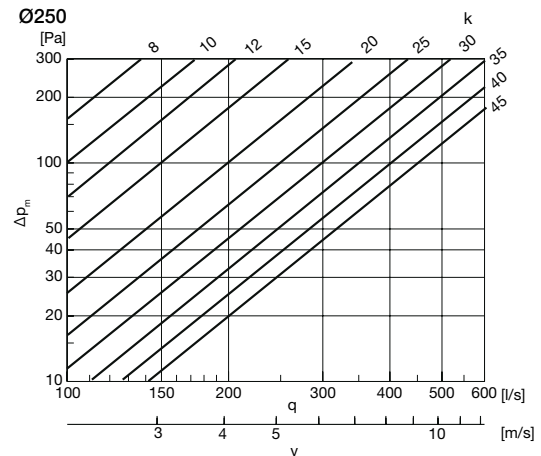
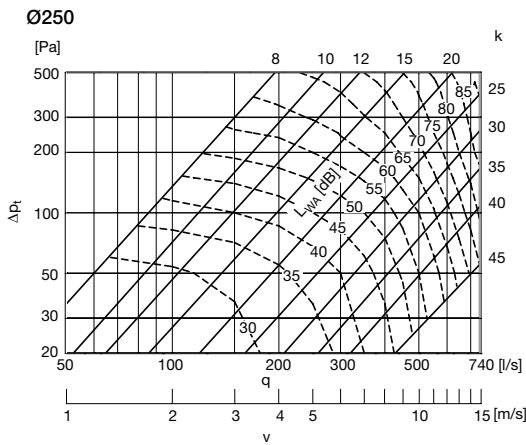

Damper with flow meter

DIRU, DIRBU, DIRVU

Pressure drop graphs with noise generation for dimensioning

Flow graphs for balancing

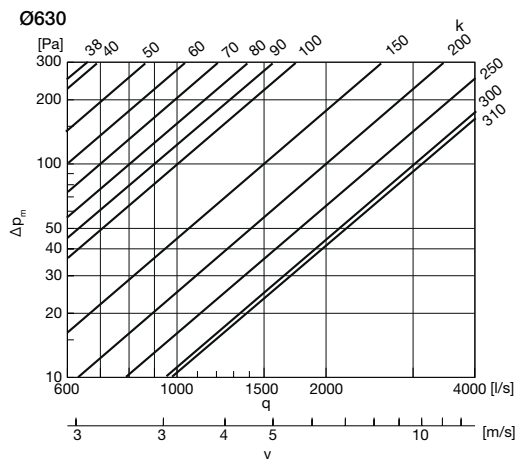
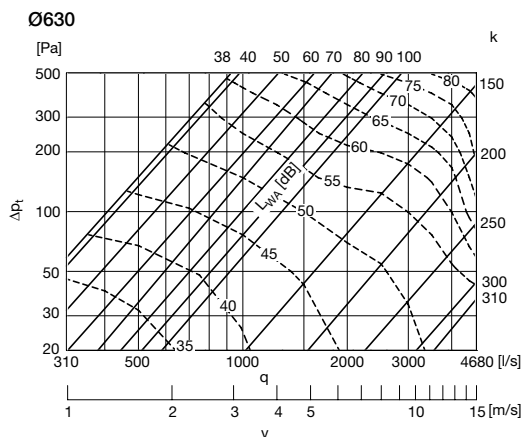
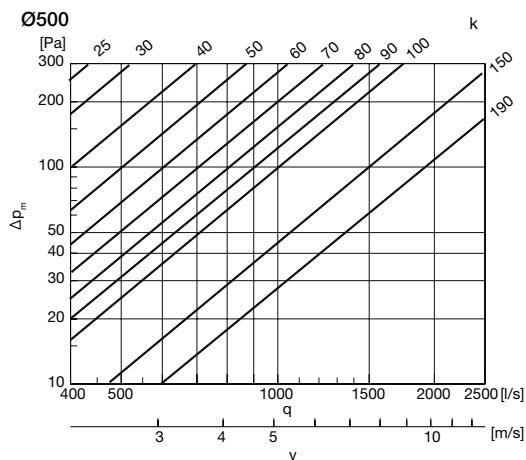
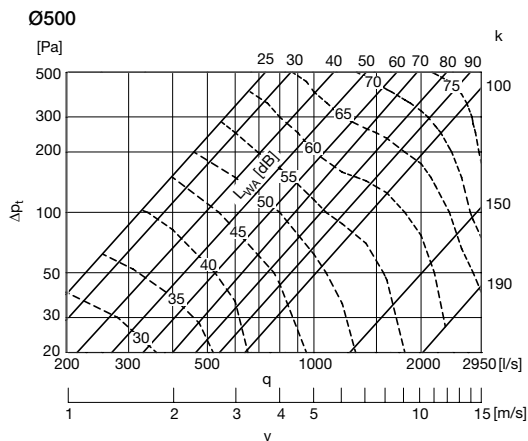
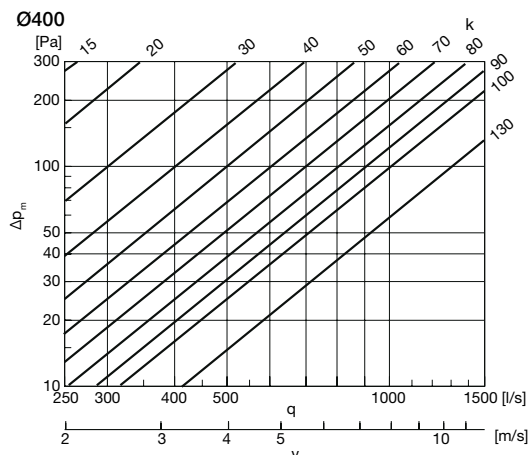
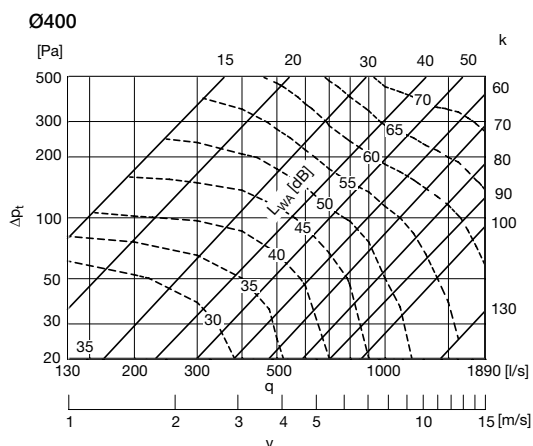

Damper with flow meter

DIRU, DIRBU, DIRVU

Measurement accuracy

If the velocity profile is asymmetric, the measurement values can differ from the ideal values. For this reason, the flow meter should never be located right up to any flow disturbance. The method error in the table below will differ, depending on the distance to the flow disturbance.

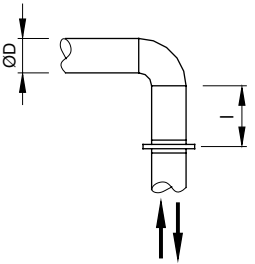
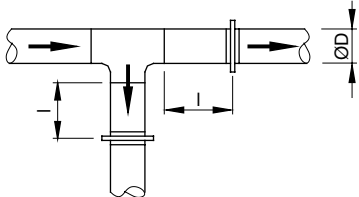
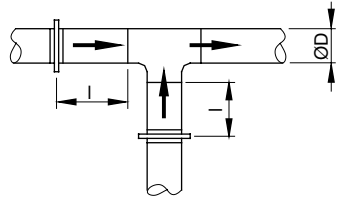
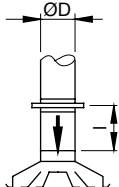
| l = straight distance before and after disturbances | Method error $\pm 7\%$ |
|---|---------------------------|
|  | $l \geq 1 D$ |
|  | $l \geq 1 D$ |
|  | $l \geq 3 D$ |
|  | $l \geq 3 D$ |

Damper with flow meter

DIRBU, DIRVU

Assembly

The damper which is considered as a component (not ready-to-use-product) are only to be put into operation after it has been built into machines or duct systems and when the system is found to be in conformity with all relevant regulations.

Mount the damper according to “Assembly Instructions Lindab Safe” to meet the requirements for tightness class C.

Dampers with dimension 400, 500 and 630 are provided with transport protections. Remove these before assembly. Consider required straight distance after or before disturbance, as mentioned on the card attached to the measurement nozzles, to obtain accurate flow measurement.

The damper may not be loaded with weight from connected ducts, specially when assembled vertically. Make sure that there is enough free space for moving parts.

Installation, electrical connection and commissioning are only to be performed by authorised personnel and in accordance with the requirements of the installation.

Electrical connection shall be done according to the wiring diagram on the motor, in the catalogue and the markings on the cable.

The damper must not be used in an explosive atmosphere or connected to flue ducts.

The damper can have sharp edges and corners which may cause injuries. It also has moving parts.

Do not lift the dampers by the electric cable.

Before initial operation, check the following:

- electrical connection has been properly completed.
- Safety devices are in place.
- Leftover installation materials and foreign materials have been removed from the casing.
- Make sure the damper is functional by checking the end positions: press the button on the motor and move the lever to each end.

When putting in operation, check the following:

- Smoothness of motor operation and no abnormal noises.

Measuring

By measuring the pressure difference Δp in Pa between the measure nozzle, you can through the equation $q=k \cdot \sqrt{\Delta p_m}$ on the damper derive the flow q [l/s]. Do not forget to plug the nozzles after measuring.

$$q_{\text{other density}} = q_{\text{equation}} \times \sqrt{\frac{1,2}{\rho_{\text{other}}}}$$

Balancing

The damper is delivered fully open. Set the maximum and minimum flow by connecting hoses to the measurement nozzles. Press the button on the motor and move the lever until required pressure for maximum flow receives. Fasten the left screw on the motor. Repeat the procedure to set the minimum flow and fasten the right screw.

Measurement accuracy

Consider required straight distance after or before disturbance, as mentioned on the card attached to the measurement nozzles, to obtain accurate flow measurement. The accuracy is $\pm 7\%$ when required distance is complied.

Damper with flow meter

DIRBU, DIRVU

Maintenance

The product normally doesn't require any maintenance but before maintenance, service or repair make sure that:

- power supply is interrupted (all-pole circuit breaker)
- observe personnel safety regulations

Do not use high-pressure cleaner when cleaning the damper. Care must be taken during cleaning so the motor is not damaged.

Cleaning

By fully opening the damper, one gets access to the duct. Do not forget to readjust the damper after cleaning.

CE-marking

Our dampers with electrical actuators are considered as ductwork components and do not need to be separately marked. Their electrical actuators however are a part of the electrical system and are consequently marked. Declaration of Conformity is to be found at www.belimo.com.

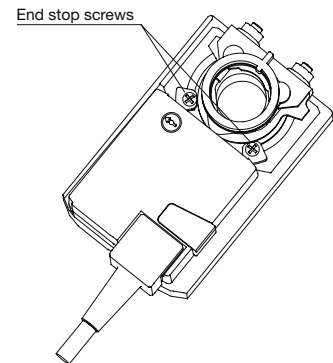

Damper with flow meter

DIRBU, DIRVU

DIRBU

Technical data for the motors

| | LM 24 A | LM 230 A |
|---------------------------------|--|-----------------------------------|
| Power supply..... | AC 19,2–28,8 V, 50/60 Hz DC 19,2–28,8 V | AC 85–265 V, 50/60 Hz |
| Power consumption | 1 W | 1,5 W |
| For wire sizing | 2 VA | 4 VA |
| Connection | Cable 1 m, 3x0,75 mm ² | Cable 1 m, 3x0,75 mm ² |
| Operating angle..... | Max. 95°, adjustable 0–100% | Max. 95°, adjustable 0–100% |
| Torque at rated voltage..... | Min. 5 Nm | Min. 5 Nm |
| Direction of rotation..... | Switch selectable 0 ↻ or 1 ↻ | Switch selectable 0 ↻ or 1 ↻ |
| Position indication..... | Mechanical | Mechanical |
| Running time for 95° | 150 s | 150 s |
| Sound power level..... | Max. 35 dB (A) | Max. 35 dB (A) |
| Protection class..... | III Safety extra-low voltage | II Safety insulated |
| Protection type..... | IP 54 | IP 54 |
| Ambient temperature range | -30 to +50°C | -30 to +50°C |
| Ambient moisture | 95 % RH | 95 % RH |

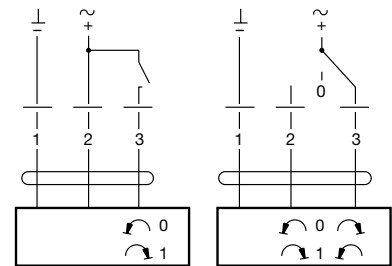

DIRVU

Technical data for the motor

| | LM 24 A-SR |
|---------------------------------|------------------------------------|
| Power supply..... | AC 24 V, 50/60 Hz DC 24 V |
| Power consumption | 1 W vid nominellt vridmoment |
| For wire sizing | 2 VA |
| Connection | Cable 1 m, 4x0,75 mm ² |
| Operating angle..... | Max. 95°, adjustable 0–100% |
| Torque at rated voltage..... | Min. 5 Nm |
| Direction of rotation..... | Switch selectable 0 ↻ eller 1 ↻ |
| Position indication..... | Mechanical |
| Running time for 95° | 150 s |
| Sound power level..... | Max. 35 dB (A) |
| Protection class..... | III Safety extra-low voltage |
| Protection type..... | IP 54 |
| Ambient temperature range | -30 till +50°C |
| Ambient moisture | 95 % RF |

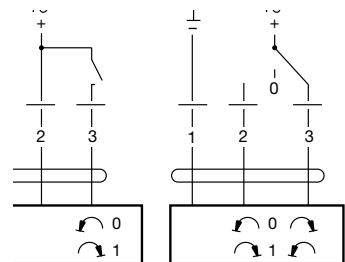

UltraLink® Controller FTCU

Planning

The longer distance to disturbance, i.e. the longer straight duct before the UltraLink®, the higher the measurement accuracy will be. It is not recommended to mount the UltraLink® so that the first flow sensor (* in the table on the next page) is placed on an outer radius of a fitting. Never use an UltraLink® on the outlet side of a duct fan. Place it on the inlet side or in worst case use a flow conditioner if it must be placed on the outlet side.

The sensor and the damper bodies can rotate relative to each other. This means that the sensors can be optimally positioned independently of the desired position of the display and damper body. View table on next page for directions on how to position the sensor body for optimal performance.



Mounting

Position the Controller so that the display is visible from some direction. For future connections it is important that the screws on the lid of the display can be removed. Make sure the airflow arrow is pointing in the direction of the airflow. Note the ID-number of the monitor. The ID can be found on the label of the box the monitor was delivered in or on the label on the monitor and are the three last numbers of the serial number.

Mount the Controller into the air duct system according to the mounting instructions for Lindab Safe. Do not use the flow sensors as handles when you mount the Controller since they may break and changes in their positions might influence the measurement accuracy. When the sensor body is positioned accurately it should be connected with screws to the damper body in the same way as when you connect ducts and fittings.

The Controller can be connected to a RTU (remote terminal unit) via analog or RS485 communication (Modbus). To be able to connect cords to the terminal board the rubber cable grommet on the back of the display unit must be punctured, preferably using an awl or something pointy to ensure tightness to the environment. When the cords have been connected they must be strain relieved. The cords can be attached to the shelf by using cable ties that are attached around cut outs in the shelf. You must under no circumstances make any holes or connect anything with screws to the sensor body since this will have an impact on measurement accuracy.

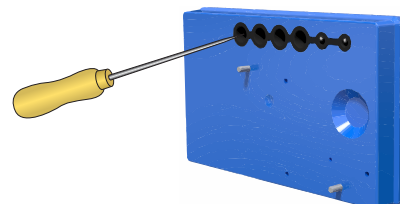
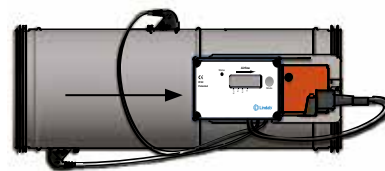

| Disturbance | * Placement of first flow sensor | Measurement uncertainty ± % or 1 l/s depending which is the greatest | | | |
|-------------|----------------------------------|---|---------|-------|---|
| | | a | | | |
| | | 2-4·Ød | >4-5·Ød | >5·Ød | |
| Bend | | Inner radius | 5 | 5 | 5 |
| Bend | | Outer radius (Not recommended) | 20 | 10 | 5 |
| Bend | | Side | 10 | 5 | 5 |
| T-piece | | Inner radius | 10 | 5 | 5 |
| T-piece | | Outer radius (Not recommended) | 20 | 10 | 5 |
| T-piece | | Side | 10 | 5 | 5 |
| Reducer | | Duct diameter decrease | 5 | 5 | 5 |
| Reducer | | Duct diameter increase | 10 | 5 | 5 |

UltraLink® Monitor FTMU

Planning

The longer distance to disturbance, i.e. the longer straight duct before the UltraLink®, the higher the measurement accuracy will be. It is not recommended to mount the UltraLink® so that the first flow sensor (* in the table on the next page) is placed on an outer radius of a fitting. Never use an UltraLink® on the outlet side of a duct fan. Place it on the inlet side or in worst case use a flow conditioner if it must be placed on the outlet side. View table on next page for directions on how to position the UltraLink® for optimal performance.

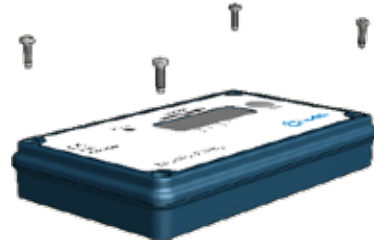

Mounting

Place the Monitor so that the display is visible from some direction. For future connections it is important that the screws on the lid of the display can be removed.

Make sure the air flow arrow is pointing in the direction of the air flow.

Note the ID-number of the Monitor. The ID can be found on the label of the box the Monitor was delivered in or on the label on the Monitor and are the three last numbers of the serial number.

Mount the Monitor into the air duct system according to the mounting instructions for Lindab Safe.

Do not use the flow sensors as handles when you mount the Monitor since they may break and changes in their positions might effect the measurement accuracy.

Minimum straight distance after the Monitor is 1·Ød.

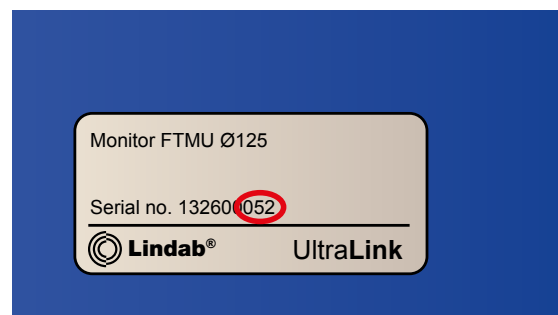
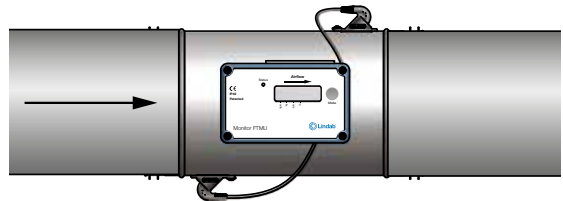

| Disturbance | * Placement of first flow sensor | Measurement uncertainty ± % or 1 l/s depending wich is the greatest | | | |
|-------------|----------------------------------|--|---------|-------|---|
| | | a | | | |
| | | 2-4×Ød | >4-5×Ød | >5×Ød | |
| Bend | | Inner radius | 5 | 5 | 5 |
| Bend | | Outer radius (Not recommended) | 20 | 10 | 5 |
| Bend | | Side | 10 | 5 | 5 |
| T-piece | | Inner radius | 10 | 5 | 5 |
| T-piece | | Outer radius (Not recommended) | 20 | 10 | 5 |
| T-piece | | Side | 10 | 5 | 5 |
| Reducer | | Duct diameter decrease | 5 | 5 | 5 |
| Reducer | | Duct diameter increase | 10 | 5 | 5 |



Good Thinking

At Lindab, good thinking is a philosophy that guides us in everything we do. We have made it our mission to create a healthy indoor climate – and to simplify the construction of sustainable buildings. We do that by designing innovative products and solutions that are easy to use, as well as offering efficient availability and logistics. We are also working on ways to reduce our impact on our environment and climate. We do that by developing methods to produce our solutions using a minimum of energy and natural resources, and by reducing negative effects on the environment. We use steel in our products. It's one of few materials that can be recycled an infinite number of times without losing any of its properties. That means less carbon emissions in nature and less energy wasted.

We simplify construction