



Ceiling heating guide

Theory water heating



Ceiling Heating Guide

Table of Contents

Introduction

Questions and Answers

Page

1. What affects the thermal climate experience?.....	4
2. How does ceiling heating work?.....	5
3. When can you use ceiling heating?.....	6
4. When is ceiling heating not advisable?.....	7
5. At what height can ceiling heating be installed?.....	8
6. Does ceiling heating affect the ventilation?.....	8
7. Will my head be too hot?.....	8
8. Will it be cold under the table?.....	9
9. Will there be a draught by the window?.....	9
10. What is the service life of Lindab Comfort's ceiling heaters?.....	10
11. Can a ceiling heating installation be modified when the activity is changed?.....	10
12. What effect should be installed?.....	11
13. Does ceiling heating save energy?.....	12
14. What does it cost?.....	12
15. Can Lindab Comfort's products be recycled?.....	14

In depth

Chapter

I. How people experience the thermal climate.....	15
II. This is how ceiling heating works.....	17
III. Where does a ceiling heater work well?.....	21
IV. Design requirements for a ceiling heater.....	22
V. Placement of the ceiling heater.....	27
VI. Temperature and the required installation height.....	29
VII. Effect and energy.....	32
VIII. Environment and recycling.....	35

Dimensioning key

Placement of the panels.....	37
Installation height and temperature.....	39

Quick facts

Quick facts – ceiling heating in a nutshell.....	40
--	----

Ceiling Heating Guide

Contents

At Lindab Comfort, we are often asked not only about our products, but also about ceiling heating, as a system, and heating principles in general. Unfortunately, ceiling heating is sometimes underestimated and misconceived as a form of heating. On the contrary, it is a very good form of heating. Far too good to be left to its own devices.

We have compiled this Guide to provide our customers and other interested parties with more information about ceiling heating. We hope that it will be useful to both project managers and purchasers who would like to find information fast, as well as to the ambitious designer who wishes to learn more about the subject.

In this Guide, which is based on a large number of Swedish and international references, the experience and measurements of purchasers and consultants, as well as our own calculations and measurements, we will demonstrate that:

- Ceiling heating heats the surfaces of the room via heat radiation. The surfaces, in turn, heat the air.
- Due to this, ceiling heating provides a very good thermal indoor climate.
- With ceiling heating, it is not too cold under the table or too hot on the head, and there is no draught from windows, as many people seem to believe.
- Ceiling heating works in virtually all types of premises, from large warehouses to small day-care centres.
- The ceiling heating system can be easily modified, if the activity in the premises changes; you do not have to worry about the heating system if you modify walls or the floor.
- Ceiling heating can be combined with any type of ventilation system.
- Ceiling heating is among the most energy-efficient systems on the market.
- Ceiling heating has a low investment cost compared to other systems. Combined with low energy consumption, it is an economical system in both the short and the long term.
- Lindab Comfort's ceiling heaters are up to 100% recyclable. Combined with their low energy consumption, this is good for future generations.

What other heating systems have all of these advantages?

The Ceiling Heating Guide is divided into three sections:

- The first, Questions and Answers, gives short and sometimes simplified answers to well-defined questions for those who do not wish to delve too deep.
- The second, In Depth, gives, as indicated by the name, a little more to chew over. This section sometimes requires knowledge corresponding to that of an HVAC engineer.
- The third, Dimensioning Key, provides a quick and easy aid for those planning a ceiling heating system.

Ceiling Heating Guide

Questions and Answers

Section 1

What affects the experience of the thermal climate?

The way we experience the thermal indoor climate depends primarily on our overall heat exchange with our surroundings. The heat exchange is affected by our physical activity, our clothing, as well as by the ambient thermal climate in the room. The thermal climate can be described by the temperature, velocity and humidity of the air and the thermal radiation exchange with the surrounding surfaces.

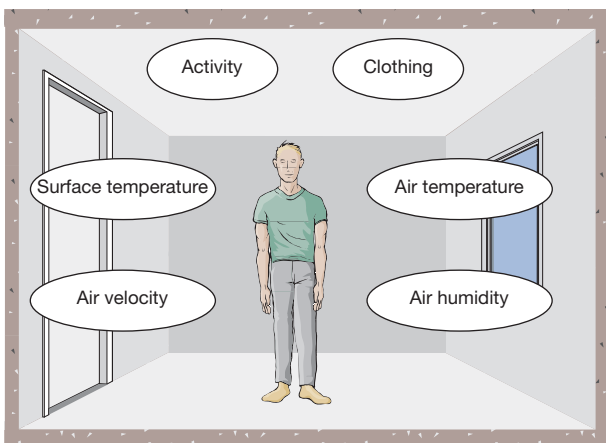

Factors affecting the thermal climate in the room.

Heat transfer

Heat can be transferred in four different ways: radiation, conduction, convection and phase transformation. Thermal radiation is what you feel, for example, from the sun or from a hotplate. Heat transfer by conduction is experienced when you walk barefoot on a cold stone floor. Convection is felt when you walk without a hat on a windy winter day. Finally, you feel phase transformation when moisture evaporates from the body, i.e. when it passes from a liquid state to a gas state and the skin is chilled.

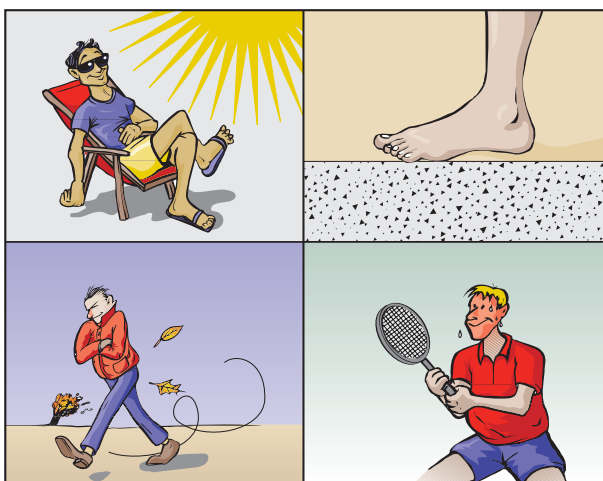

Heat is transferred in four different ways.

Heat, however, is always transferred, if there is a temperature difference between two bodies. A human body, for example, radiates heat to its surroundings all of the time. A hand or a face (approx. +33°C) continuously gives off heat through radiation to surrounding walls and furnishings (approx. +22°C), without you being directly aware. Heat is also given off by convection from the skin when air near the body is heated and rises.

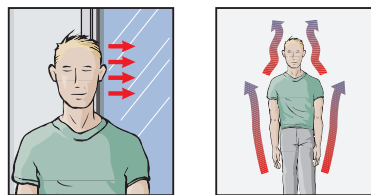

Heat is always given off by the body.

Thermal comfort

Thermal comfort means that a person on the whole feels to be in a state of thermal balance, i.e. that he or she is neither too hot nor too cold. Furthermore, thermal comfort presupposes that there is no unwanted heating or cooling of individual body parts, such as draughts to the neck or too warm a floor.

A person's heat balance, and feeling of comfort indoors, is primarily affected by:

- Convection directly to the surrounding air through skin and lungs.
- Radiation exchange with surrounding surfaces.

These two methods of heat transfer are approximately equal in size, for normal air movements in a room. Therefore, we are affected just as much by the temperatures of the room surfaces as by the temperature of the air.

If the temperature of the room surfaces increase completely, or in part, the air temperature decreases by an amount corresponding to the increase in the mean temperature of the room surfaces. If, for example, we heat a room with a ceiling heater, the mean temperature of the room surfaces will be higher. People then radiate less heat through radiation to their surroundings. To avoid being too hot, the body can compensate by increased convective heat transfer to the colder room air.

This is the background for why it is possible to have a lower air temperature with radiant heating than with conventional heating, and at the same time achieve thermal comfort.

(For an in-depth study, refer to Chapter I).

Ceiling Heating Guide

Questions and Answers

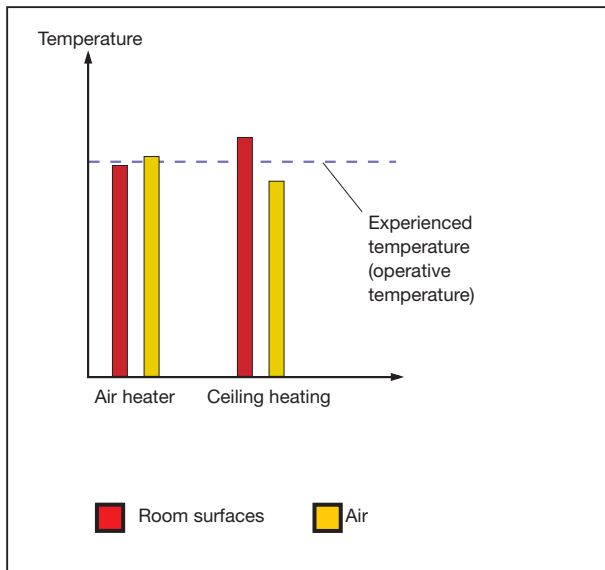

Ceiling heating provides warm room surfaces and therefore allows a lower air temperature.

Section 2

How does ceiling heating work?

Hot air rises, so why place the "radiator" on the ceiling? Yes, this is a common question from people who are doubtful about ceiling heating. In this section, we will try to explain how ceiling heating works and why it gets warm in the whole room and not just near the ceiling.

The heating system gives off heat to the surroundings through a mixture of convection and heat radiation. Convection heats up the air close to a heater, whereas thermal radiation is distributed in all directions within the room. The convectively heated air rises in the room, whereas the heat rays "travel" straight from the heater until they meet any of the surrounding surfaces.

The ceiling heating system is based on a high share of thermal radiation and a low share of convection. Typical values are approx. 60% radiation and approx. 40% convection. Lindab Comfort's ceiling heating system is waterborne and based on thermal radiation at low temperatures (30 to 80°C). This means that you do not experience the thermal radiation as intensely as the radiation, for example, from the sun or an electric infrared heater.

The convection share for a ceiling heating system (approx. 40%) corresponds roughly to the share of heat losses through the building's climate shell, such as the heat losses through the ceiling; i.e. the other parts of the building benefit directly from the rest of the energy that is given off by a ceiling heater (the radiation share).

You can compare thermal radiation with normal light. It is distributed and reflected in approximately the same way;

i.e. heat is radiated from the ceiling heater towards all the surfaces it can "see". Since part of the thermal radiation is reflected, just like visible light, against all the surfaces and since there is a radiation exchange between room surfaces that have different temperatures; even surfaces that are "shaded" from the thermal radiation are heated. Hence, the temperature difference in the room and different surfaces continuously strives to even out. As a result, the room receives a very even temperature spread between the ceiling and the floor.

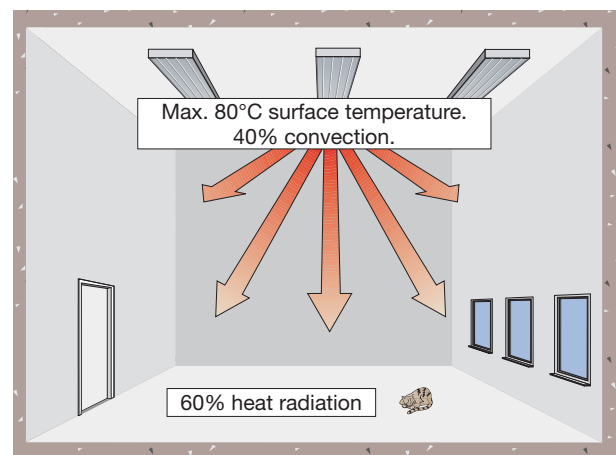

Distribution of radiation and convection for Lindab Comfort's ceiling heaters.

The surfaces, to which the radiant heat is transferred, are heated to a temperature that is higher than if conventional heating is used. For example, inner walls will normally stabilise at a surface temperature above the room's air temperature. A rarely noticed advantage of radiant heat from the ceiling is that it heats the floor! The floor temperature is normally 2 to 3°C above the air temperature at ankle height.

In other words, when you have ceiling heating installed, it is not difficult to have satisfied tenants!

The heat given off by the ceiling heater and experienced by a person, therefore, comes primarily from the indirect heat radiated by the surrounding surfaces. Only a very small part comes directly from the ceiling-heating panel itself. This experience of the thermal climate is due to the smaller heat loss from the human body to the surroundings, when the surrounding surfaces are warmer. In other words, it is not enough if only the air around us is warm! Also, refer to Section 1.

Ceiling Heating Guide

Questions and Answers

A big advantage of radiant heating is that the colder a surrounding surface is, the more heat energy it will attract to itself. This means that radiant heating spreads automatically, so that colder surfaces, e.g. windows or poorly insulated wall sections, receive a greater share of the heat, i.e. the heat ends up where it is needed the most. (For an in-depth study, refer to Chapter II).

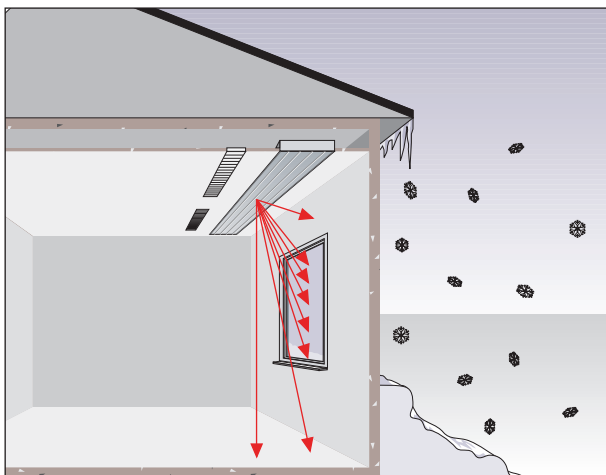

Thermal radiation goes where it is needed the most.

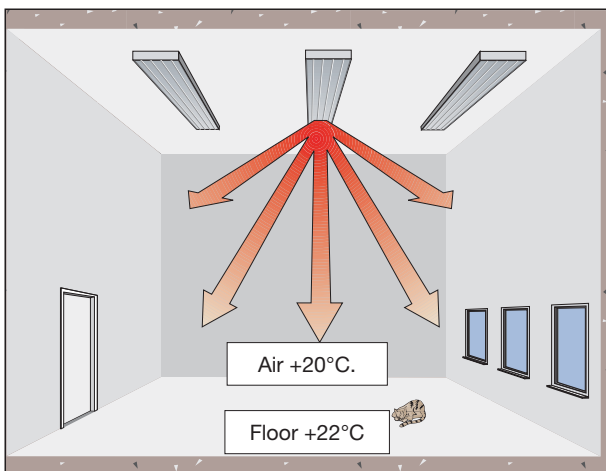

Ceiling heating provides a warm floor!

Section 3

When can you use ceiling heating?

Ceiling heating has a very wide range of application, wider than most other forms of heating. It can be said generally that ceiling heating can be used to heat nearly all types of premises. Ceiling heating is used mostly in large premises, such as sports centres, workshops, industrial halls, warehouses and shopping centres. However, ceiling heating also works excellently in premises such as day-care centres, nursing homes, residential homes, schools and laboratories.

The output of a ceiling heater is divided into approx. 40% convective (heat to the ceiling) and approx. 60% radiant heat (heat downwards). Buildings normally have the same distribution of heat losses through the walls, ceiling and floor, i.e. approx. 40% of the heat is lost through the ceiling and the other 60% through the rest of the building. This is why ceiling heating, together with its other advantages, is ideal for heating nearly all types of buildings.

Domestic residences are one area where ceiling heating is installed very rarely. A major reason for this is probably that home heating is based on strong traditions. However, it has been demonstrated in studies that ceiling heating panels, combined with outdoor air terminals for the exhaust air system, give very good climatic results compared to conventional radiator systems. In one trial, the ceiling heating panels were mounted on the ceiling directly above the window in a bedroom. Outdoor air was sucked through a grill in the outer wall and was preheated between the ceiling and the ceiling panel.

In summary, it was established that:

- The supply air was heated on average to 15.5°C, with an outdoor temperature of -2°C.
- The operative temperature was on average approx. 1.1°C higher than for a corresponding reference room with panel radiators.
- No draughts were ascertained (the window was heated by the ceiling heater; also refer to Section 9).

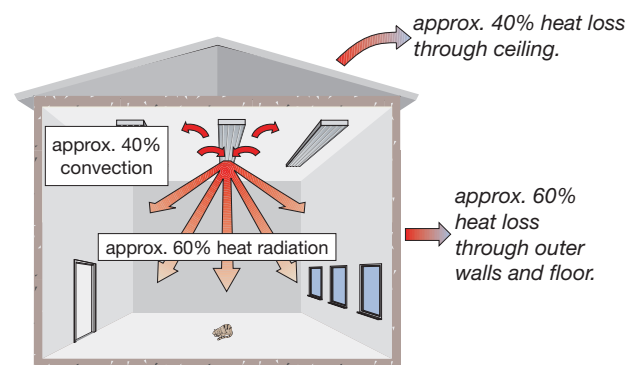

Distribution of the heat produced from ceiling heating and from a building.

Ceiling Heating Guide

Questions and Answers

Ceiling heating also works well in premises where people sit to perform concentrated work, as well as in premises where people stand or move around. The ceiling height, in practise, has no importance; either upwards or downwards, for the provision of a warm climate in the occupied area (refer also to Chapter 5 and 7).

Zone heating

Ceiling heating also provides excellent results if only part of a room needs heating, so-called zone heating. For example, work places can be arranged in the premises, where the activity requires a low temperature. Radiant heating can then contribute to an increase in the experienced temperature (the operative temperature) through a local increase in the temperature of the surrounding surfaces and, to a certain degree, in the air temperature, thereby creating a more tolerable working environment.

Other advantages of ceiling heating:

A big advantage of ceiling heating is that the heaters are "out of the way". The placement of furnishings, machinery and other equipment does not usually need to be taken into consideration, and the ceiling heating panels do not take up any space on the walls or the floor.

Ceiling heating panels and heating strips are also relatively easy to move, if a room is to be used for other activities or if walls are to be moved.

In schools and public premises, for example, the heaters are not accessible for tampering. (For an in-depth study, refer to Chapter III and Chapter VI).

Section 4

When is ceiling heating not advisable?

There are not many cases where ceiling heating does not work, but each technology has its limitations. The following example illustrates the limitations of ceiling heating:

Ceiling heating does not work any better than other heating systems in preventing air leakage through open doors. The floor, walls and any furnishings close to the door are heated, of course, but ceiling heating does not prevent air leakage through an open door. However, ceiling heating contributes towards providing the best possible thermal climate in the zone around the door by keeping the surfaces warm, as cold air flows in when the door is open.

In high towers, e.g., a lighthouse, ceiling heating works less well also, as very little of the radiant heat that is given off reaches the floor and the occupied zone. However, this is not caused by the long distance to the floor but by the fact that the floor occupies a relatively small part of the total surface "seen" by the ceiling heater. A large part of the thermal radiation will be absorbed by the wall surfaces.

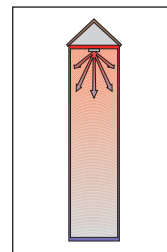

Ceiling heating provides poorer results in high narrow spaces.

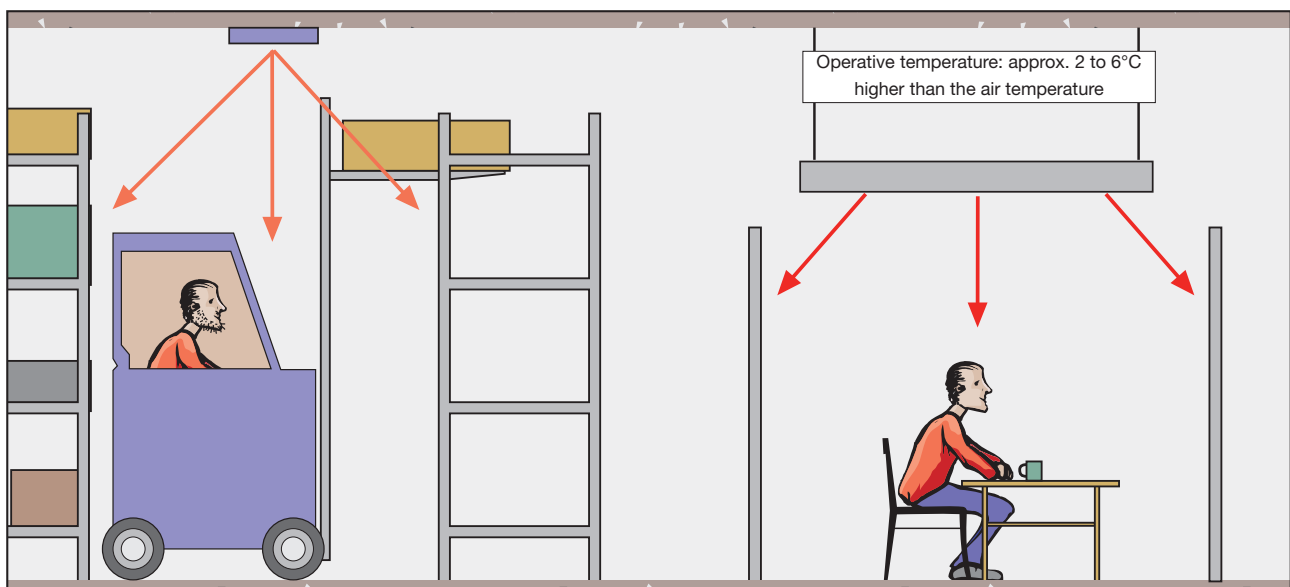

Zone heating provides a higher operative temperature in part of the room.

Ceiling Heating Guide

Questions and Answers

Section 5

At what height can ceiling heating be installed?

As long as the air in the room is of normal cleanliness, there are no limitations, other than the building itself, for the height the ceiling panels can be installed. The radiant heat is not obstructed by the air and is distributed towards the floor, walls and furnishings irrespective of the installation height and the surface temperature of the ceiling heaters.

However, there are limitations for how the low ceiling heating can be installed. Factors that play the greatest role for the lowest possible installation height are the surface temperature of the ceiling heater, followed by factors such as the heater's length/width ratio, and whether the occupants of the room are sitting or standing. The warmer the surface is, the greater the installation height for the ceiling panel must be for a person below the panel not to experience any discomfort. However the limitations to the lowest possible installation height are moderate, refer to Section 7.

An example to prove this:

A ceiling heating panel with the dimensions 3.6 x 0.6 and a maximum surface temperature of 50°C (55/45°C system) can be installed as low as 2.1 m (!). If the surface temperature increases to 70°C (80/60°C system), the lowest installation height is 2.8 m.

In this connection, it is important to point out that we are talking about here are design heating temperatures that statistically occur only a few days per year. During most of the year, the heating temperature in the system is lower.

(For an in-depth study, refer to Chapter II and IV).

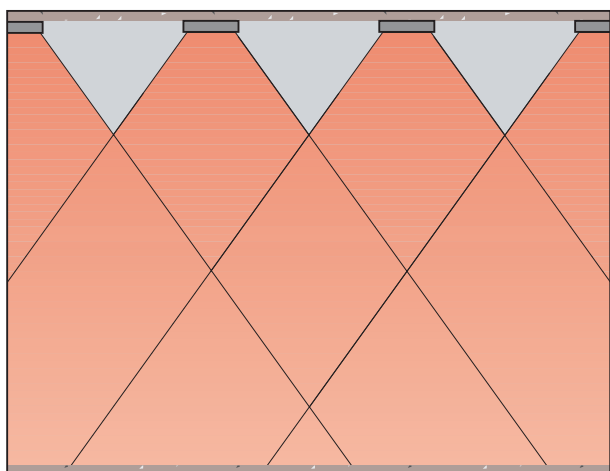

The ceiling height plays no role; all radiant heat reaches all walls and floors. It is only the intensity that diminishes with the height.

Section 6

Does ceiling heating affect the ventilation?

Ceiling heating in itself does not cause any air movements that can affect any form of ventilation. This means that ceiling heating is perfect for premises where there are high requirements on the control of the airflow.

This also means that you have a free hand in selecting the type of ventilation system to be used in combination with ceiling heating, when you plan new buildings or renovate existing buildings and rooms.

(For an in-depth study, refer to Chapter V).

Section 7

Will my head be too hot?

The radiant temperature asymmetry (RTA) is a concept used to define the temperature differences on different surrounding surfaces a person can accept without experiencing discomfort. RTA is noticed if, for example, you turn one side of your face against a warm fireplace and the other towards a cold window.

RTA is measured over a small area with a height of either 0.6 m, which corresponds to a sitting person, or 1.1 m, which corresponds to a standing person. RTA is the difference between the thermal radiation on each side of the measurement area.

As previously mentioned in Section 2, thermal radiation from the ceiling heater warms the surrounding surfaces and especially the floor. As a result, the RTA is balanced out. An important factor for the RTA to be within acceptable limits, however, is that the ceiling heater is dimensioned correctly, with regard to its maximum temperature.

If this prerequisite is met, the RTA will be within the limits for a comfortable indoor climate as provided for by the Guidelines (R1) of the Swedish Indoor Climate Institute and the International Indoor Climate Standard ISO 7730.

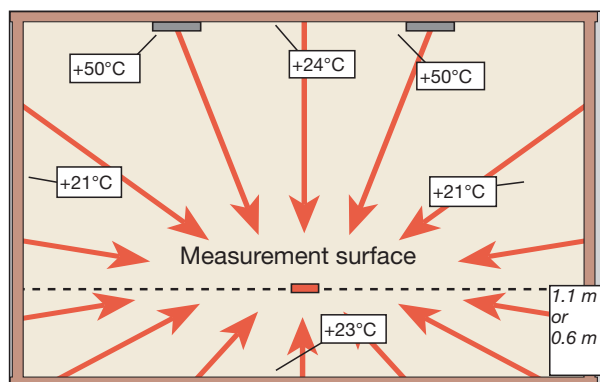

Example of how radiant temperature asymmetry (RTA) is measured. RTA is the difference between the thermal radiation on each side of the measurement surface. The temperatures are given only as an example.

Ceiling Heating Guide

Questions and Answers

Section 8

Will it be cold under the table?

It is a widespread misconception that when ceiling heating is used as the heating system, it will be cold under the table and any other horizontal surfaces. The chances of it being cold under a table are the same of it being pitch dark under a table when the ceiling lamp is on.

Thermal radiation spreads to surrounding areas in the same way as light rays from the ceiling. These surfaces absorb most of the heat energy, but also reflect a small part of it. This part of the thermal radiation "bounces" around to the different surfaces in the room and heats the surrounding surfaces, including the floor under the table. Even the top and underneath of the table are warmed by direct and indirect thermal radiation. This means that the difference in air temperature or radiant temperature is extremely small under the table compared to next to the table.

(For an in-depth study, refer to Chapter II).

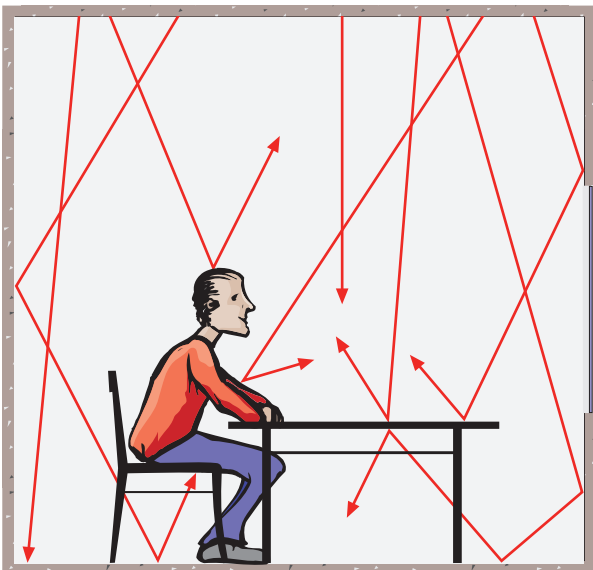

The thermal radiation is partially reflected and it cancels out the difference in temperature.

Section 9

Will there be a draught by the window?

With double and triple-glazed windows, there can be a risk of draughts (i.e. air movements caused by air that is cooled against a cold surface), if there is no heat source by the window to counteract the downward air stream. The heat source, however, does not need to be located under the window. A radiator under a window results in a warm rising air stream that should counteract any draught from the window. On the other hand, ceiling heating prevents draughts at their source, i.e. the cold surface of the window. The ceiling heaters namely heat the surface of the window, so the risk of draughts is minimised.

In other words, the ceiling heating heats up cold surfaces directly via heat radiation. As mentioned in Section 2, the thermal radiation is distributed among the room surfaces in proportion to their surface temperatures; i.e. more heating effect goes to colder surfaces. Thermal radiation from the ceiling will therefore heat, in part, the window surface and window bay and, in part, the windowsill. In this way, draughts from the window are eliminated directly at "source", in part, due to the warmer window surface and, in part, due to the heating effect of the window bay and the windowsill.

The greatest risk for experiencing discomfort from draughts is borne by people with sedentary work, dressed in light indoor clothing, who have their work places near an outer window and are without a heat source to counteract any draughts. With standing work or work "on foot", away from an outer window, the risk is non-existent, especially in newer premises with triple glazing.

(For an in-depth study, refer to Chapter II).

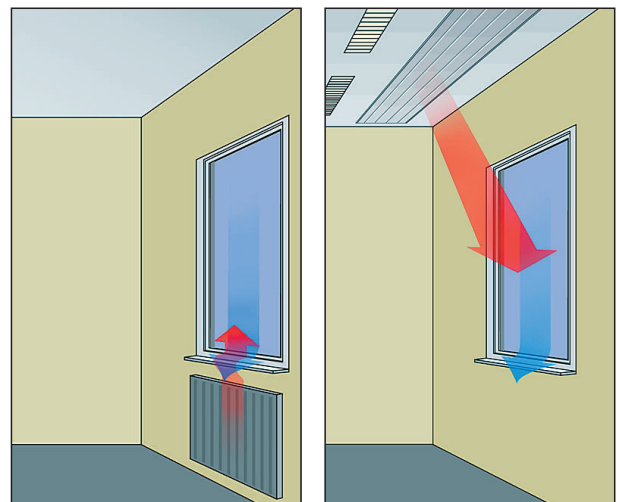

The ceiling heater prevents draughts by heating the window surface.

Ceiling Heating Guide

Questions and Answers

Section 10

What is the service life of Lindab Comfort's ceiling heaters?

Lindab Comfort's basic element, our world patent, is used in heating and cooling systems, as well as in solar collectors throughout the world, where temperatures are up to 250°C. At the Technical Research Institute of Sweden, surfaces have been tested at over 200°C, shock cooling them afterwards with 10°C water. The surfaces have also been left outdoors, and after several years, they have been taken in and tested again. The surfaces have also been pressure-tested at a pressure of 10 to 11 bar – 16,000 times! None of these tests has affected the quality or performance of the product.

We do not know a product on the market that has been as thoroughly tested as the products of Lindab Comfort. We therefore dare say that Lindab Comfort's ceiling heaters can function for as long as the building in which they are installed.

(For an in-depth study, refer to Chapter IV).

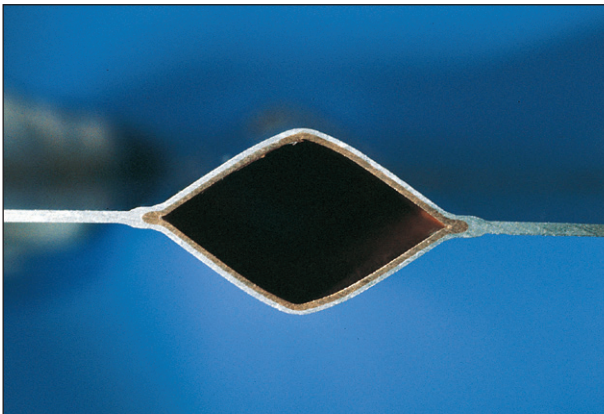

Cross-section of the water duct of Lindab Comfort's ceiling heater.

Section 11

Can a ceiling heating installation be modified when the activity is changed?

Nowadays, it is common for a building and its interiors to undergo many changes during the building's service life. It is therefore necessary to be able to modify and move both walls and installations without the costs being too high.

In this respect, ceiling heating offers great advantages. The piping system is often fitted visibly or in an easily removable suspended ceiling, which makes it easy to dismantle or rebuild. If the ceiling heaters are installed in a cassette ceiling, they can be easily switched with ceiling cassettes in the places where the ceiling heaters are needed. If they are suspended, it is also easy to dismantle and move them to another place.

There is also an advantage only offered by Lindab Comfort's ceiling heating products. They have the lowest weight on the market, which means that modifications in the ceiling heating installation, especially at very high ceiling heights, are extremely easy.

Property owners/managers are not bound to a special type of tenant. They can switch, for example, between a manufacturing industry, a dance studio and a warehouse. You do need to take the heating system into consideration when renovating or rebuilding the floor or the walls.

Ceiling Heating Guide

Questions and Answers

Section 12

What effect should be installed?

When calculating the design heating effect requirement, the different parts of the building are calculated first, with regard to area and total heat transfer coefficient (U value). This is normally calculated in accordance with the existing building regulations and the Swedish Standard.

In addition, it is calculated what the indoor temperature and the design outdoor temperature, DOT, should be.

The latter is normally calculated according to the Swedish Standard. A calculation of the design heating effect can then be made for the building.

However, you should consider during the calculations that there is a temperature difference between the ceiling and the floor (temperature gradient). The temperature gradient can result in large temperature differences between the floor and ceiling at high ceiling heights. One of the great advantages of ceiling heating is that the temperature gradient is small compared to other heating systems, approx. $0.5^{\circ}\text{C}/\text{m}$. This results in small temperature differences between the ceiling and the floor. Heating with, e.g. a fan heater (Aerotemper) results in a temperature gradient of approx. $2^{\circ}\text{C}/\text{m}$. A small temperature gradient naturally results in a lower heating effect requirement, as the indoor temperature by the ceiling is lower.

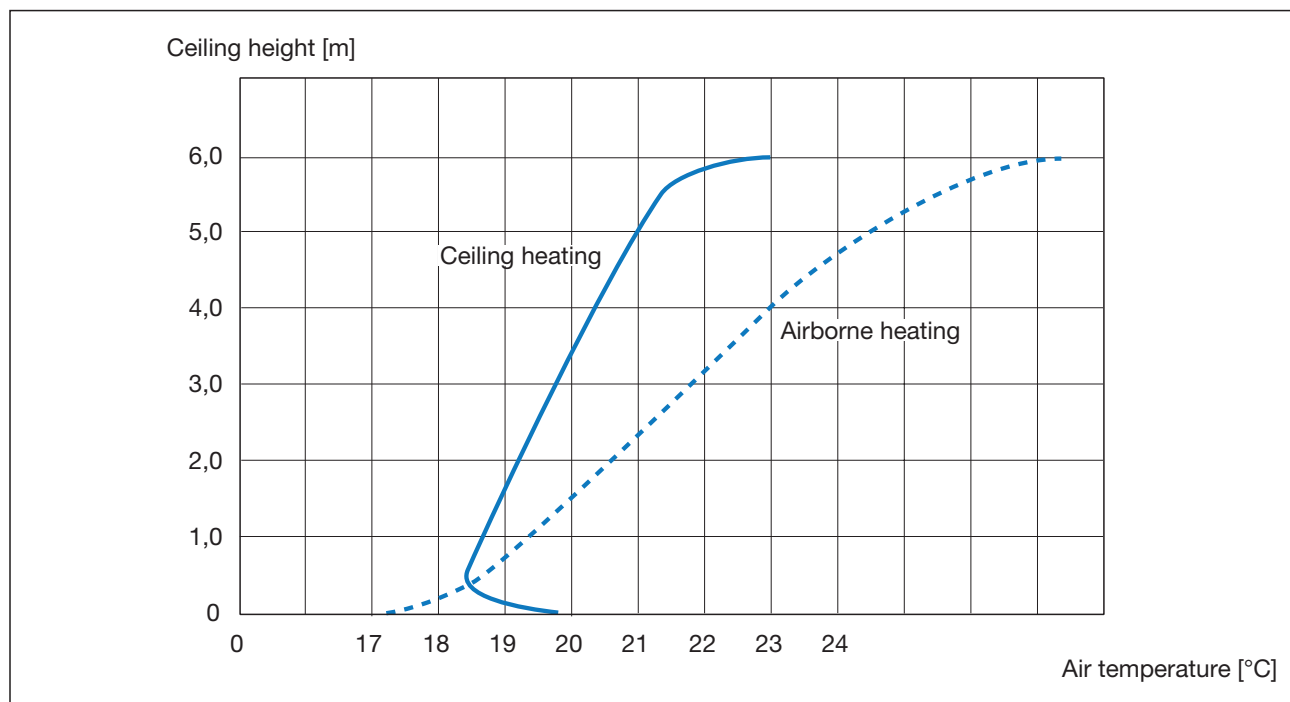

Example of temperature distribution in the air in a room with different heating systems.

Ceiling Heating Guide

Questions and Answers

Apart from the low temperature gradient, with ceiling heating you can also normally reckon with approx. one to two degrees lower indoor temperature with new construction, due to the radiant supplement from the surrounding surfaces (refer to section 1 and 2). In this way, you can lower the installed heating effect. However, when rebuilding or renovating, you should perform a more accurate analysis to see if the building's standard, after the work and activity in it, is such that you can reckon with a lower indoor temperature.

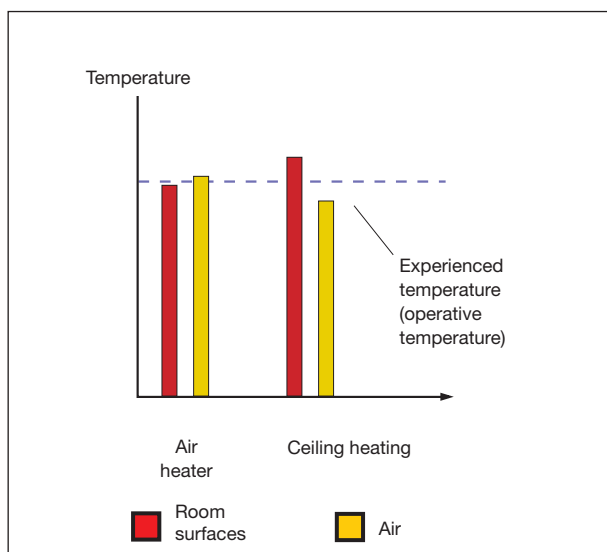

Ceiling heating provides warm room surfaces and therefore allows a lower air temperature, resulting in a lower heating effect requirement.

An example can explain the difference in output requirement due to a lower indoor temperature and a smaller temperature gradient; assume a newly-built hall of 1000 m² with a ceiling height of 5 m and normal wall, ceiling and floor structures. The window area corresponds to 10% of the floor area. The necessary heating effect for transmission and involuntary ventilation for two different heating systems will then be, as follows (heating effect for ventilation is not included):

Heating system	Temp. in occup. area/gradient	Heat output
Fan heater (Aerotemper)	20°C / 2°C/m	71.3 kW
Ceiling heating	18°C / 0.5°C/m	58.5 kW

The ceiling heating system therefore requires only 82% of the heating effect, compared to fan heater system, in this example. It should be stressed that the difference is smaller in premises with lower ceiling heights.

(For an in-depth study, refer to Chapter VII).

Section 13

Does ceiling heating save energy?

In the vast majority of cases, you can say yes to this question when you compare ceiling heating with other conventional heating systems. The energy saved by ceiling heating is partially dependent on its ability to maintain a lower air temperature in the occupied area (approx. 1 to 2°C) without lowering the experienced (operative) temperature and partially on the smaller difference between the temperature of the ceiling and the floor (the temperature gradient, refer to Section 1 and 12). The second factor contributes to a smaller air cushion on the ceiling, which would otherwise result in large heat losses through the ceiling.

The type of building and what the previous heating system was, if any, determines how large the energy saving will be. For buildings with a ceiling height of 2 to 3 metres, you can count on a saving of 2 to 7%. For buildings with higher ceiling heights, the energy saving can be even greater, especially if the building is old, has leaks or big doors or openings that give a large proportion of air leakage (involuntary ventilation). Savings of up to 30% have been documented in both Swedish and foreign research reports.

(For an in-depth study, refer to Chapter VII).

Section 14

What does it cost?

The answer to this question differs, depending on the time perspective and the costs that are to be included. We have chosen a long-term perspective, in this case 15 years, since then the overall cost picture, in most cases, is more interesting for the manager or property owner. However, if you only look at the investment costs in the example, ceiling heating is the second cheapest.

The example shows the total cost calculation for four different heating systems. The systems are ceiling heating, floor heating, fan heating (Aerotemper) and air heating.

The preconditions for the calculation are also presented and are based on an assumed new-built industrial hall with dimensions of 60 x 40 m and a ceiling height of 8 m situated in Gothenburg, Sweden. The hall is assumed to be connected to Gothenburg's district heating network. The investment costs include materials and labour costs, including connection charges for the district heating and adjustment work for the respective heating systems. The investment costs for the different heating systems, including the ceiling heating system, have been calculated by an independent consulting firm.

Annual operating and maintenance costs (O&M) are calculated as a percentage of the investment and include electricity and maintenance and repair costs. For ceiling and floor heating, these are assumed to be 0.5% and for fan heating and air heating to be 2% of the investment cost.

Ceiling Heating Guide

The energy consumption for the different heating systems, including the heating energy requirement for transmission and involuntary ventilation, has been calculated under the assumptions given below. The energy requirement for ventilation is not included as it is assumed to be equal for all the heating systems.

Questions and Answers

The total cost for the respective systems, including investment cost, operating and maintenance costs and energy costs. The total cost is presented in part as a present value and in part as annual payment.

Common prerequisites:	
Cost of capital:	10%
Economic service life:	15 years
Energy price:	450 SEK/MWh
Energy price increase:	2% per year

Heating system	Investment (SEK)	O&M (SEK/year)	Energy consumption (MWh/year)	Total cost	
				Present value (SEK)	Annual payment (SEK/year)
Ceiling heating	840.00	4.200	386	2.373.000	311.997
Floor heating	945.000	4.725	375	2.439.000	320.703
Fan heating	777.000	15.540	488	2.792.998	367.206
Central air heating	2.170.500	43.410	431	4.176.810	549.141

Costs for different heating systems. Investment costs have been calculated by an independent consulting firm.

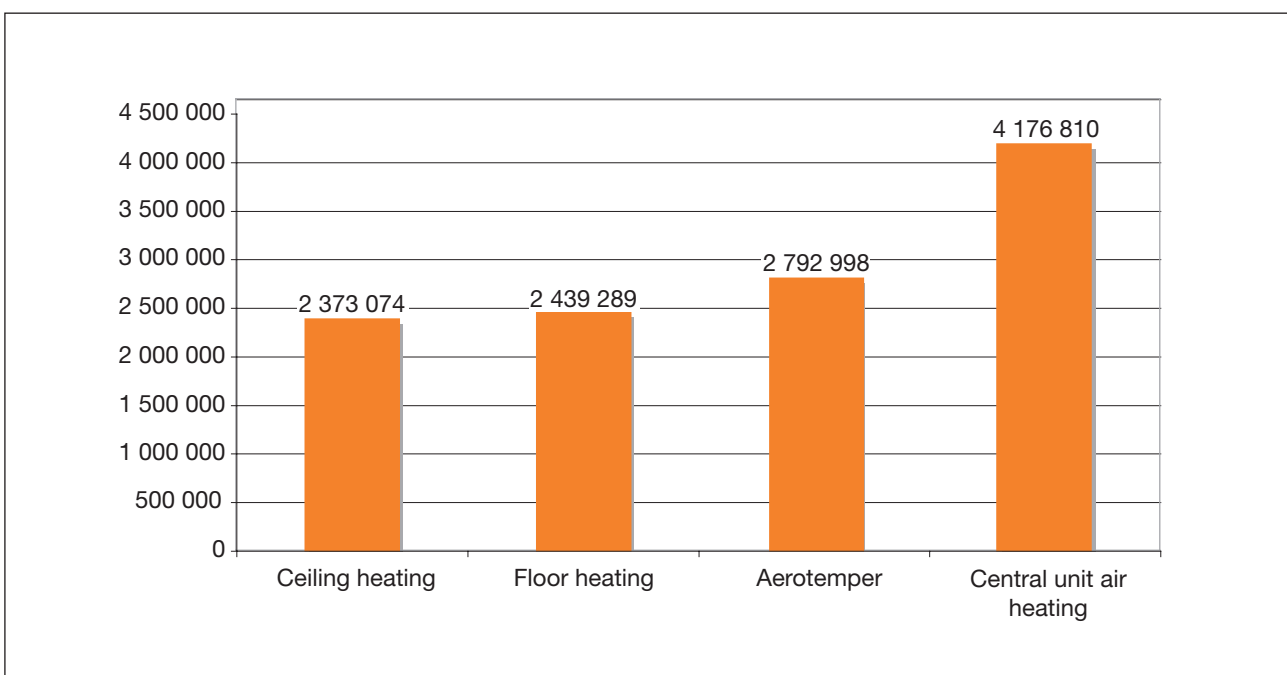

Present value of total costs for four different heating systems.

Ceiling Heating Guide

Questions and Answers

Calculation conditions:

U value	ceiling:	0.2 W/m ² , °C
	walls:	0.2 W/m ² , °C
	floor inner zone:	0.3 W/m ² , °C
	floor outer zone:	0.3 W/m ² , °C
	windows:	2.0 W/m ² , °C
Area	ceiling:	2.400 m ²
	walls:	1.400 m ²
	floor inner zone:	1.000 m ²
	floor outer zone:	200 m ²
	windows:	200 m ²
Ceiling height:	8 m	
Involuntary ventilation:	0.3 qty/h	

	Ceiling heating	Floor heating	Fan heating	Air heating
Indoor temp. occupied area (°C)	19	19	20	20
Temperature gradient (°C/m ²)	0.7	0.5	2.0	1.0

Other conditions:

1. Ceiling heating and floor heating require a lower air temperature, 19°C, to maintain a certain operative temperature, which in this case is assumed to be 20°C.
2. The indicated temperature gradient applies at the design outdoor temperature. At other outdoor temperatures, it is assumed to drop linearly until it is zero - when there is no heat requirement.
3. The temperature gradient for air heating applies when so-called tropic fans are installed.

Section 15

Can Lindab Comfort's products be recycled?

Life cycle analyses (LCA), which have been made for aluminium products, show many common features. The material's production stage (mining, concentration and production) have a relatively high load factor, with respect to both energy and environment. Compared to other materials, the reverse situation is observed in the product utilisation stage. The load of the aluminium products in the production stage is compensated for many times over by their lower environmental impact in the utilisation stage.

Moreover, if the aluminium is recycled, the impact on the environment from the production stage is further reduced to a corresponding degree.

Lindab Comfort's ceiling heating systems consist exclusively of copper, aluminium, an insulating sheet of expanded polystyrene and a small amount of tin solder. All component materials, excluding the insulating sheet, are up to 100% recyclable. All production waste goes for recycling, even today.

When a building, where Lindab Comfort's ceiling heating products are installed, is demolished, 100% of the metals in them can be recycled. The aluminium and copper are bonded metallurgically in the manufacturing process and cannot be separated, but nevertheless recycling is still possible. The ceiling heaters are pressed in to a package of approx. 20 x 20 cm and are used in the metal industry as alloying materials in different qualities of aluminium. The copper proportion is well defined for each of the packages, as each centimetre of the panel contains the same percentage of copper.

(For an in-depth study, refer to Chapter VIII).

Ceiling Heating Guide

Chapter I.

How people experience the thermal climate

Heat exchange

A person's heat exchange with the surroundings depends on activity, amount of clothing and on how much heat is transferred to the surroundings, above all by convection and radiation. Some heat is given off in the form of latent heat as water vaporises. This heat is normally not supplied to the room, but is transferred to outdoors through condensation.

Activity

Activity or metabolism determines how much heat is generated in the body. It is expressed in the unit met (1 met = 58 W/m²). An individual's degree of activity indoors normally varies between 0.8 met (sleeping) and 7 met (hard physical work). Common values for normal office activity is 1.1 to 2.2 met. The metabolism of a person doing a certain type of work is also determined by individual factors such as age, weight, sex, health, etc.

Amount of clothing

The amount of clothing is a measure of the human body's heat insulation and is expressed with the unit clo (1 clo = 0.155°C m²/W). It varies between 0 clo when naked and approx. 3 clo under thick bedding. Common indoor clothing falls in the range of 0.7 to 1.2 clo.

Personal heat exchange

Personal heat exchange normally takes place primarily through convection and radiation. These are roughly equal at small air velocities. When air passes by the skin at a higher velocity than approx. 0.1 m/s, the convective heat transfer gradually increases. If the person becomes too hot and begins to sweat, a significant amount of heat is also given off by moisture evaporating from the body (phase transformation). In a state of thermal comfort, the sweat production is very little and the moisture that nevertheless evaporates from the skin is reckoned with the convective heat given off. Air humidity affects the amount of moisture that evaporates from the skin and the mucous membranes. The drier the air, the greater the amount of moisture that is given off by the skin and the mucous membranes.

Convection

The convection that a person is exposed to consists, in part, of natural convection, which occurs due to people heating the air around the body, which then rises and causes air movement and, in part, of forced convection, which is external air movements, e.g. from ventilation or draughts. The limit for unpleasant air velocity depends primarily on the surrounding temperatures. The normal limit indoors is therefore 0.15 m/s in the winter and 0.2 to 0.4 m/s in the summer [8], see page 34. The higher value during the summer is because the room temperature is often higher during the summer months. Thus, the limit for unpleasant air velocity is also higher.

Radiation

Radiation takes place as a net exchange between two bodies/surfaces and in most cases goes from a person to the colder surroundings. The amount of heat transfer by radiation depends on the person's activity and amount of clothing, as well as on the surface temperatures of the surroundings.

Temperature

As regards the temperature of the air and the surrounding surfaces, there are a number of different temperatures that are defined to describe the effect on people. The most common ones are presented below.

Apart from room temperature, there are also: Vertical temperature gradient (°C/m): a measurement of how much the air temperature changes at different heights above the floor. Normally defined as the temperature difference between a height of 0.1 m and 1.1 m. The temperature gradient should be less than 2 to 3°C/m to avoid discomfort. The lower value is used for sedentary work. It should, however, be pointed out that a temperature gradient of 2 to 3°C/m causes significant layering of the air and thereby large energy losses at ceiling level. The temperature gradient for Lindab Comfort's ceiling heaters is normally within the range of approx. 0.4 to 0.5°C/m, which results in a significant reduction in energy losses at the ceiling level. Also, refer to Chapter VII.

Plane radiation temperature (°C): used to determine the radiation exchange for a small plane surface (skin section) that faces a specific direction. Radiation exchange depends on the surface temperature and the angle factor from the sub-surface concerned, which can be "seen" by the plane surface. The plane radiation temperature is calculated using the measured surface temperatures and angle factors or is measured with a radiation temperature meter.

Radiant temperature asymmetry (°C): Radiant temperature asymmetry (RTA) is defined as the difference in the plane radiation temperature on each side of a small flat surface. RTA is measured in a plane at 0.6 m above the floor level when sitting and 1.1 m above floor level when standing. Where the thermal radiation comes from the ceiling, the maximum value for the RTA should be 5°C. Also, refer to Chapter VI.

Mean radiation temperature (°C): a measurement to determine the body's total radiation exchange with the surrounding surfaces. The mean radiation temperature refers to the mean value of the radiation exchange in all directions.

Operative temperature (°C): describes the overall effect of the air temperature and the mean radiation temperature on an individual's heat balance. The operative temperature is often assumed to be the mean value of the air temperature and the mean radiation temperature.

Ceiling Heating Guide

Directed operative temperature (°C): a concept in Swedish building regulations used to describe the heat exchange for a small section of skin. Defined for a certain measurement point and direction in the room as the mean value of the air temperature and the plane radiation temperature.

Equivalent temperature (°C): a measurement to describe the combined effect of the air temperature, radiation temperature and air velocity on a person's heat balance. The relation is also affected by the person's activity and clothing.

Thermal comfort

The indoor climate conditions that provide thermal comfort differ from one person to another. Trials performed by Professor P O Fanger [21], where large groups of people were exposed to different climatic affects, show, however, that most people react to the indoor climate in a similar fashion. The trials have led to criteria for thermal comfort based on climatic conditions under which a majority of a large group of people experiences the climate as neutral.

Using some of the climatic factors mentioned above, it is possible to calculate the degree of thermal comfort by using a PMV index (Predicted Mean Vote). The value defines a statistically based prediction for how a large group of people would rate the degree of comfort for a certain climate at a given degree of activity and clothing. Based on the PMV index, you can calculate a PPD index (Predicted Percentage of Dissatisfied), which indicates what part of a larger group of people find a certain indoor climate unsatisfactory.

$$PMV = (0.303 \times \varepsilon^{-0.0036M} + 0.028) [(M-W) - 3.05 \times 10^3 \{5733 - 6.99(M-W) - p_a\} - 0.42\{(M-W) - 58.15\} - 1.7 \times 10^{-5} \times M(5867 - p_a) - 0.0014 M (34 - t_a) - 3.96 \times 10^{-8} f_{cl}\{(t_{cl} + 273)^4 - (t_r + 273)^4\} - f_{cl}h_c(t_{cl} - t_a)]$$

where:

$$t_{cl} = 35.7 - 0.028(M-W) - 0.155I_{cl}[3.96 \times 10^{-8} f_{cl}\{(t_{cl} + 273)^4 - (t_r + 273)^4\} - f_{cl}h_c(t_{cl} - t_a)]$$

$$\left\{ \begin{array}{ll} h_c = 2.38(t_{cl} - t_a)^{0.25} & \text{for } 2.38(t_{cl} - t_a)^{0.25} > 12.1(v_r)^{0.5} \\ h_c = 12.1(v_r)^{0.5} & \text{for } 2.38(t_{cl} - t_a)^{0.25} < 12.1(v_r)^{0.5} \end{array} \right.$$

$$\left\{ \begin{array}{ll} f_{cl} = 1.00 + 0.2I_{cl} & \text{for } I_{cl} < 0.5 \text{ clo} \\ f_{cl} = 1.05 + 0.1I_{cl} & \text{for } I_{cl} > 0.5 \text{ clo} \end{array} \right.$$

Key:

- M = Metabolism (W)
- W = External labour (W)
- I_{cl} = Amount of clothing (clo)
- p_a = Water vapour partial pressure (P_a)
- f_{cl} = Clothing surface factor, i.e. the relation between naked skin and clothed skin
- t_{cl} = Clothing surface temperature (°C)
- h_c = Convective surface coefficient of heat transfer (W/m² °C)
- t_r = Mean radiation temperature (°C)
- t_a = Room air temperature (°C)
- v_r = Relative air velocity (m/s) = v + 0.005(M-58)
- v = Mean room air velocity

When the PMV index is known, the PPD index can be calculated:

$$PPD = 100 - 95 \times \varepsilon^{-(0.03553PMV^4 + 0.02179PMV^2)}$$

Calculating the PPD index manually in each given case is a very lengthy process with these formulas. It is significantly easier to use climate simulation software that gives the PPD index or other climatic indices as a result of a simulation of the conditions in a room. Lindab Comfort's own climate simulation programme TEKNOsim provides, among other things, the air temperature, operative temperature and PPD index.

According to Fanger's formula, a maximum of 95% of the people can be satisfied with a given indoor climate, i.e. at least 5 per cent will always experience a given indoor climate as uncomfortable (PPD = 5% and PMV=0 indicate the best possible thermal comfort). In the Swedish Indoor Climate Institute's publication R1 [8], the defined classes for thermal indoor climate are based on the PPD index, which ranges from <10% dissatisfied for the highest class to 20% dissatisfied for the lowest class.

Ceiling Heating Guide

Chapter II

This is how ceiling heating works

Lindab Comfort's ceiling heating products utilise thermal radiation as the primary way of transferring heat (approx. 60% of the total heating effect). In this chapter, we review the fundamentals of heat radiation.

Heat radiation

Thermal radiation is electromagnetic radiation with a wavelength of approx. 9 to 15 mm, at a surface temperature of 30 to 70°C. The hotter the surface is, the shorter the wavelength, and the colder the surface, the longer the wavelength. Thermal radiation at these temperatures is invisible to the naked eye. It is first when the surface temperature approaches 600 to 800°C that thermal radiation starts to be visible to the eye.

Thermal radiation is given off by all bodies that are warmer than absolute zero (-273,16°C). The absolute thermal radiation of a body is seldom of interest. On the other hand, the net exchange of radiation energy between two bodies or surfaces is of interest for performing calculations in technical contexts.

Heat transfer by radiation

Heat transfer (net exchange) by radiation depends on the temperature difference between the surfaces, their geometrical relationship and nature. The heat flow, P_s , between two surfaces is formulated with the following formula:

$$P_s = \sigma F_{12} A_1 (T_1^4 - T_2^4) \text{ (W)}$$

where

$$F_{12} = \frac{1}{\frac{1}{f_{12}} + \left(\frac{1}{\varepsilon_{12}} - 1\right) + \frac{A_1}{A_2} \left(\frac{1}{\varepsilon_2} - 1\right)}$$

Here f_{12} is a function of the geometrical relationship between surfaces A1 and A2 and is called the angle factor. The angle factor can be calculated or read off from diagrams in heat transfer handbooks. When thermal radiation is calculated, it is always the projected area of a surface that is used; i.e. the net exchange in thermal radiation from a folded or ribbed surface does not increase compared to that from a smooth surface.

$$s = 5.67 \times 10^{-8} \text{ W/m}^2 \text{ K}^4$$

(Stefan-Boltzman's constant)

ε_1 = The heat radiating surface's emission factor

ε_2 = The receiving surface's emission factor

A_1 = The heat radiating surface's projected area (m²)

A_2 = The receiving surface's projected area (m²)

T_1 = The heat radiating surface's temperature

(K = Kelvin, which is T°C +273)

T_2 = The receiving surface's temperature (K)

It is important to remember that the radiation exchange between two surfaces (e.g. a ceiling heater and a floor) does not decrease with distance, so long the air that the radiation passes through is of normal cleanliness. This is due to the negligible absorption of thermal radiation by the air, see below. On the other hand, radiation intensity (output per surface unit), along with the transferred energy, diminishes if the distance increases or if the surface is slanted. This affects the angle factor, which is included in factor F_{12} and depends on the distance and angle between the surfaces and the size and temperature of the surfaces. A well-known example of the variation of the radiation intensity is the solar radiation intensity throughout the day and even throughout the year. Solar radiation towards the Earth varies, in part, with the distance to the Earth and, in part, with the angle to the Earth.

The surface with the lower temperature will be the recipient of the net exchange of thermal radiation. In ceiling heating, it is always the surrounding room surfaces that are the recipient of the thermal radiation. In other words, with radiant heating the surrounding surfaces that have a lower temperature than that of the radiation heater will absorb the heat radiation, thereby increasing their own temperature, normally several degrees above the temperature of the room air.

The air's significance

When thermal radiation passes through the air, virtually no radiation is absorbed. However, the two gases, carbon dioxide (CO₂) and water vapour (H₂O), absorb and emit heat radiation, whereas the so-called elementary gases (gas where the atoms are of one kind), e.g., O₂, N₂ and H₂, are transparent to thermal radiation. As the air is composed of different gases, where CO₂ (0.05 weight %) and H₂O (0.7 weight %) have very low concentrations and O₂ (21 vol%) and N₂ (79 vol%) have high concentrations, the air can be considered to be completely transparent to thermal radiation at normal air thickness (< 20 m). However, an abnormally high concentration of particles in the air could exercise minor influence on the heat exchange between a ceiling heater and the surrounding surfaces.

Ceiling Heating Guide

Emission factor

The emission factor, e , indicates how much energy a surface radiates compared to a perfect radiant surface, a so-called black body. The emission factor is equal to 1 for a black body and between 0 and 1 for all other materials. The higher the emission factor, the better the surface works as a thermal radiator and heat recipient. The list below shows the emission factor of some materials perpendicular to their surface and at normal room temperature:

Aluminium, rolled bright:	0.04
Copper, polished:	0.03
Glass:	0.94
Wood (beech):	0.94
Brick, plaster:	0.93
Concrete:	0.88
White enamel (Lindab Comfort's heaters):	0.95
Matt black enamel:	0.97

As seen from the table, all surfaces except for metal ones are good thermal radiators/recipients.

The values show that a white enamelled surface is nearly as good as a matt black enamelled one. This is one of the reasons why Lindab Comfort's ceiling heating panels are enamelled on the underside but not on the top. The top surface of the ceiling heater is normally of oxidised aluminium, which has a higher emission factor than rolled bright aluminium but much lower than a white enamelled surface. In this way, the radiant energy can be "guided" to the underside of the heater where it is needed the most. To guide further the thermal radiation downwards, the top is also insulated.

It is worth noting that glass has a relatively high emission factor and that it is at the same level as some of the most common construction and furnishing materials. As regards glass, low-temperature radiation cannot pass through it; any such radiation is either absorbed (approx. 88%) or reflected (approx. 12%). Solar radiation, however, with its significantly higher temperature and shorter wavelength, passes through. This is the reason why the expression "greenhouse effect" is used for greenhouses and other buildings with large glass surfaces.

Thermal comfort with heat radiation

In relation to their surroundings, people are warm bodies and therefore radiate some surplus heat to their surroundings. When the surrounding surfaces have a higher temperature than normal, which is the case with radiant heating, there is less radiation from the body. In a room with radiant heating, a person will therefore experience the surroundings as warmer, as his or her radiation to the surrounding surfaces will be lower than with conventional heating at the same air temperature.

As a result of this, when you have radiant heating, you can lower the air temperature and nevertheless maintain the same operative temperature. Under normal circumstances, you can lower the air temperature by 1 to 2°C [4] and still achieve the necessary operative temperature.

The thermal radiation in a room is either absorbed or reflected. When radiated heat is absorbed, the surface temperature increases. With normal furnishing and construction materials, the reflected portion of the radiation is only 5 to 10%, which means that most of the thermal radiation is absorbed. This is the primary reason why the surface temperature of the underside of a table [1] is a few degrees above the air temperature. All surfaces, including all furnishings and furniture, absorb thermal radiation and become warmer than the ambient air temperature. This means that both the air temperature and the operative temperature will be balanced, even in parts of the room that are not directly "seen" by the ceiling heater.

In [1], the difference between the air temperature under and next to a table is given as 0 to 0.9°C depending on the measuring case. It is worth noting that the surface temperature on the underside of the table was 0.7 to 3.2°C higher than the air temperature. This shows that the table is heated by the thermal radiation from the ceiling. In [2], the difference in air temperature under and next to a school desk is shown to be a maximum 0.3°C. The difference in radiation temperature here is given to be a maximum of 1.6°C. According to our own measurements, conducted in different environments, such as day-care centres, offices, schools and industries, the difference in operative temperature under and next to a table, respectively, is within the range of 0.2 to 0.4°C.

Draughts

There are a number of factors that influence if, and how strongly, you will experience draughts from a window. The most important ones include the U value of the window, the design of the window bay, the ventilation principle, the placement and properties of the air unit, the heating system, the person's clothing and activity, the geometry and furniture of the room, infiltration and outdoor temperature [5] [6] [7]. In other words, it is not only a question of whether the heater is under the window or on the ceiling.

Ceiling Heating Guide

A supply air unit with rear-edge air supply with too long a throw and low supply air temperature can also be a reason for draught formation. With radiators under the windows, furnishing can be a critical factor, for example, if a table is placed close to the window. The rising hot air is then shielded from the radiator under the table, and the draught "flows" over the table and then down towards the floor [7].

[1], [2] and [3] show increased surface temperatures on the inside of the window as the glass surface absorbs heat radiation. A joint result for all three is that the radiant heat is distributed differently across the window surface. The window has a higher surface temperature in its upper part and a somewhat lower one in its lower part. An increase of approx. 2 to 10° is registered depending on the measuring point and the case. It is important to point out that double-glazed windows were used in all cases. In modern houses with triple glazing, the temperature increase will be even higher. Our own measurements of window surface temperatures heated by ceiling heaters indicate that, at an outdoor temperature of between 0°C and -5°C, double-glazed and triple-glazed windows have a surface temperature of 12 to 17°C and 17 to 20°C, respectively.

In [2], it was noted that a room with windowsills has a favourable effect on the draught from the window. This happens because the windowsill is both heated by ceiling heater and deflects the downward air stream, thereby admixing warmer room air.

Calculation example

The formula for radiant heat transfer says that the temperature difference between two surfaces plays a relatively important role, especially if the temperature is expressed in Kelvin and raised to the power of four. The formula also says that more thermal radiation automatically goes to colder surfaces than to warmer ones, and it is this condition that is perfect for a heating system.

The diagram here shows how the thermal radiation spreads across a wall surface (outer wall). The calculation of the heat exchange between the ceiling heaters and the wall has been made for each decimetre of the wall, according to the formulas in Chapter II and the formulas for the angle factor. Two ceiling heaters are mounted on the ceiling parallel to the wall, at 1.7 m and 5.25 m from the wall, respectively. These dimensions are taken from the diagrams in Chapter V that describe the placement of the ceiling heaters. The assumed conditions apply during a cold winter day.

It is interesting to note that the thermal radiation of the two panels reaches its maximum on different parts of the wall. This is caused by the geometrical relationship, i.e. the angle factor is different for the two heating panels in relation to the wall.

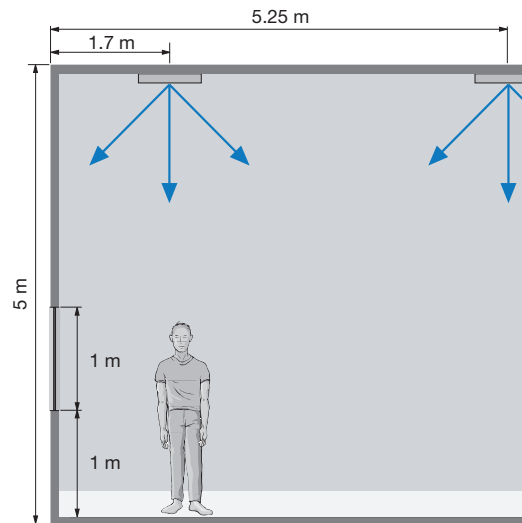

Room assumed in the calculation example.

It is also clear that the window receives a large share of the thermal radiation compared to the wall next to the window. The reason for this, as indicated above, is that the window surface is colder and thereby "sucks" more radiant heat. As a result, the window surface will be heated considerably more than if the room's heat source was completely convective, e.g. a fan heater. If the window surface is heated to approx. +15°C, the risk of draughts from the window is reduced significantly.

To sum up, we can establish that the following applies to ceiling heating applications in buildings and rooms:

- The emission factor for indoor surfaces is relatively equal, approx. 0.88 to 0.95.
- The ceiling height has no importance for the transfer of radiant heat from ceiling heaters to other surfaces.
- The transfer of radiant heat automatically increases if the recipient surface has a lower surface temperature.
- The air temperature can normally be reduced by 1 to 2°C, while maintaining the operative temperature, thanks to the fact that the surrounding surfaces are heated by the ceiling heating system.
- With ceiling heating, there will be small differences in the air temperature and operative temperature under and next to a table, respectively.
- Radiant heat from the ceiling panel heats the inside of a window, thereby minimising the risk of draughts.

Ceiling Heating Guide

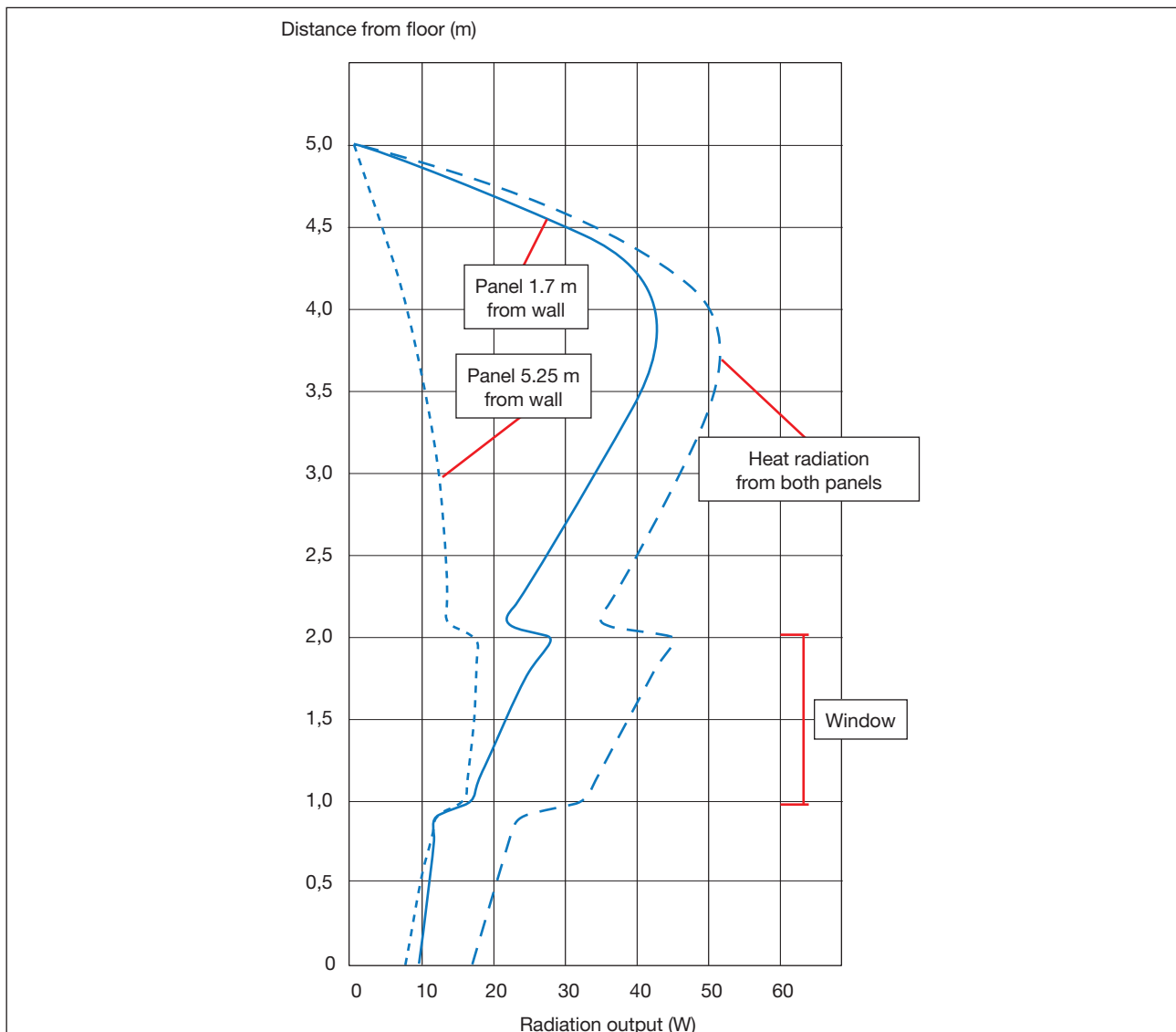

The diagram shows how the transferred heat output from two panels is distributed on a façade wall with a window.

The following input data is assumed:

- Wall:
 - height: 5 m
 - width: 10 m
 - emission factor: 0.9
 - surface temperature: 22°C
- Window:
 - breast height: 1 m
 - window height: 1 m
 - width: 10 m
 - emission factor: 0.94
 - surface temperature: 15°C
- Ceiling heater:
 - width: 1 m
 - length: 10 m
 - emission factor: 0.95
 - surface temperature: 40°C
 - installation height: 5 m

Ceiling Heating Guide

Chapter III

Where does a ceiling heater work well?

Ceiling heating has a very wide range of application, wider than most other forms of heating. It can be said generally that ceiling heating can be used to nearly all types of premises. Ceiling heating is primarily used in different premises, such as sports centres, workshops, industrial halls, warehouses and shopping centres. However, ceiling heating also works very well in premises such as day-care centres, nursing homes, residential homes, schools and laboratories.

The output of a ceiling heater is divided into approx. 40% convection and approx. 60% radiation. The convective heat is transferred to the air next to the ceiling, and contributes to covering the transmission losses through the ceiling. The share of heat transferred through radiation mainly goes to the floors and walls.

Buildings normally have the same distribution of heat losses through the walls, ceiling and floor, i.e. approx. 40% of the heat is lost through the ceiling and the other 60% through the rest of the building. This is why ceiling heating, together with all of its other advantages, is ideal for heating nearly all types of buildings. Below we present a transmission calculation for a building, and the result shows that the distribution of transmission losses is of the magnitude described above.

Input data:

DOT ₁₀ :		20°C
Annual mean temp.:		6°C
U value	Ceiling:	0.2 W/m ² , °C
	Wall:	0.2 W/m ² , °C
	Floor, inner:	0.3 W/m ² , °C
	Window:	2.0 W/m ² , °C
Area	Ceiling:	800 m ²
	Walls:	600 m ²
	Floor, in:	680 m ²
	Floor, out:	120 m ²
	Window:	30 m ²
Temperature gradient:		0.7°C/m
Ceiling height (mean):		5.0 m
Length:		40 m
Width:		20 m
% Window area:		5% of wall area
Indoor temp. Occupied zone:		18°C
	Mean:	20°C
	Ceiling:	22°C

Output data:

Effect requirement:	Ceiling:	6.640 W	38%
(Transmission)	Walls:	4.770 W	28%
	Floor, in:	2.448 W	14%
	Floor, out:	2.448 W	7%
	Windows:	2.280 W	13%
	Total:	17.278 W	100%

Ceiling Heating Guide

Chapter IV

Design requirements for a ceiling heater

The design and technical solutions for a ceiling heater are different from one manufacturer to another. The requirements for a well-functioning ceiling heater, however, are the same and are largely based on the physical laws that govern heat transfer.

Basic requirements for a ceiling heater

One of the most important requirements of a ceiling heater is that there is an equal temperature across its surface. This gives maximum output per unit area. If the water temperature in a heating system, for example, is 55 to 45°C or 60 to 40°C, i.e. the mean water temperature is 50°C $(55+45)/2$, then the desired temperature across the entire surface of the product should also be 50°C. However, this is a practical and even theoretical impossibility (it would require infinite heat conductivity) as there will be heat losses on the way from the water in the pipe to the surface of the product. The goal is therefore to reduce these heat losses as much as possible. Below, we will review how this goal can be optimised and how other requirements can be met.

What should a well-designed ceiling heater look like?

There are several ways to assess the quality, operation and service life of a ceiling heater. These are:

1. Choice of material
2. How efficient is the bonding/contact between the pipe and fin
3. Optimization of the ceiling heater; heat effect/cost
4. How well is the product tested?
5. How easy is to mount the product?
6. Flexibility
7. Finish
8. Product structure

The fundamental principle of all waterborne ceiling heating products is identical. It is based on a water-carrying pipe and a radiant surface (fin). The pipe should then be connected to the fin in such a way that the heat from the water is led through the pipe wall to the fin (see picture 1).

The temperature of the fin increases, and the product starts radiating thermal radiation. To achieve the intended effect in the room, the ceiling heater is insulated on top to prevent unnecessary thermal radiation from reaching the ceiling surface.

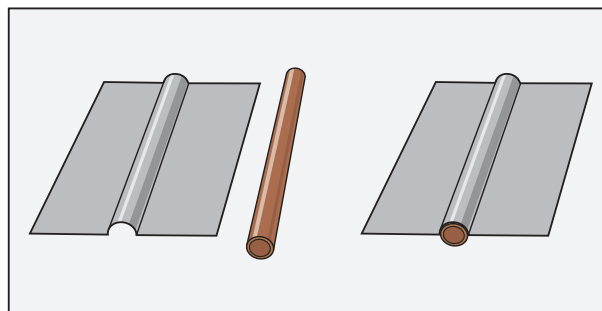

Picture 1. Basic elements in a ceiling heater.

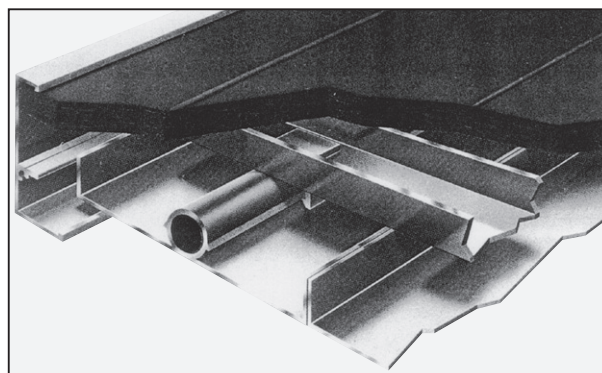

Picture 2. The pipe expanded in an aluminium profile.

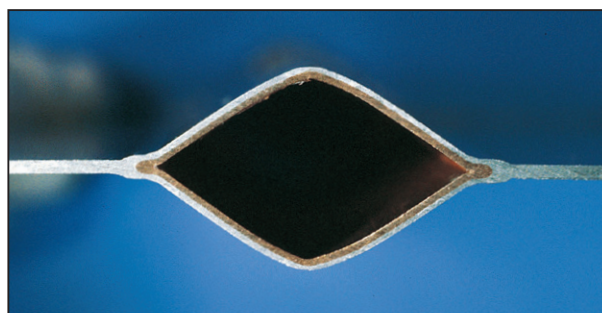

Picture 3. Cross-section of Lindab Comfort's basic element. The copper pipe and the aluminium fin are metallurgically bonded with Lindab Comfort's world patented method.

1. Choice of material

The choice of material is of decisive importance for the heating effect and the service life of the product. Nowadays, in Scandinavia only aluminium is used as the fin material. This is because aluminium conducts heat very efficiently and the product weight is low. The pipe material is either steel or copper. There are several advantages to using a copper pipe:

- The risk of corrosion is significantly lower compared to a steel pipe.
- The product weight is lower and material expansion (see next page) is more even.
- Installation is also much easier if a copper pipe is used.

Ceiling Heating Guide

2. Connection between pipe and fin

When the materials have been selected, the pipe and the fin must be joined together, so as to ensure that the contact/connection between them is as good as possible. The quality of the connection between the pipe and the fin influences to a very high degree how well a thermal radiator will work. Nowadays, three methods are used to make this connection.

1. Different methods of screwing, welding, clamping or snapping both surfaces together (see picture 1 on the previous page).
2. A pipe, usually of copper, is inserted into an aluminium profile shaped as a pipe and fin in a single unit. The pipe is then expanded into the profile so as to achieve a good contact between the different materials. See Picture 2 on the previous page.
3. A copper pipe and an aluminium fin are rolled together under very high pressure (approx. 50 tonnes) to form a single unit. The copper pipe is then blown up to normal size, thereby taking on a rhomboid shape (see picture 3 on the previous page).

Thus, the connection between the pipe and the fin in the first two methods is purely mechanical. It is not hard to imagine that a connection that is made mechanically does not provide the optimum heat transfer. A number of experiments with such solutions [14] prove that there are significant effect losses – in particular, after a long period of use. The last method provides metallurgy bonding (the materials are partially mixed through molecular bonding).

If the quality of these methods is to be determined, it could be said that the latter two are good solutions if they are done correctly. The first solution is a significantly inferior design for several reasons. Above all, this has to do with the fact that different materials expand differently when exposed to heat. The difference in expansion between steel and aluminium is much greater than the difference in expansion between copper and aluminium. What happens is that the aluminium plate "rises" from the steel plate, thereby impairing the contact between the pipe and the fin, or in other words, reducing the heating effect of the product. Moreover, these types of designs are sensitive to the way the product is handled during production, delivery and installation.

The contact between the pipe and the fin can also decrease if the product is handled negligently.

Metallurgical bonding (design no.3) gives the most advantages. The material expansion is uniform all the way, the risk of corrosion is minimised and it is not possible to impair the contact between the pipe and fin, due to handling in connection with production, transportation or installation.

Expansion coefficients for different materials:

Aluminium	24
Copper	16
Steel	12

This shows that it is an unqualified technological error to connect the different metals mechanically, as this results in effect losses for the product - this is under the condition that the point-by-point contact between the pipe and the fin is not infinite when counting the number of contact points. If the point-by-point connection is made with too much spacing, the aluminium plate (the radiant surface) will rise from the steel or copper pipe, which in turn causes effect losses. A mechanical connection of a steel pipe and an aluminium plate gives the worst thermal contact.

Example:

Conditions: A steel pipe is joined mechanically (point by point) with an aluminium fin.

WS: 80/60°C

Room: 20°C

Result: The aluminium plate will rise 0.6 mm from the steel pipe, i.e. the contact will be achieved only at certain points, and these will be the only places where efficient heat transfer will take place.

Galvanic corrosion

This problem becomes more relevant for cooling, when using a chilled ceiling, where there is a risk of condensation during specific times of the year. However, it can also be relevant for heating, if there is a high humidity level in the room or if products are rinsed, especially when these are not exposed to the effects of heating. To find out what the risk is in these cases, refer to the table on the next page.

Ceiling Heating Guide

	Standard potential series relative to standard hydrogen electrode	Galvanic series in 3% NaCl relative to standard hydrogen electrode	
	Me/Me ⁿ⁺	Me/Me _Z , pH7	
Pt/Pt ²⁺	+1.20V	+0.57/Pt/PtO	Pt +0.47V
Ag/Ag ⁺	+0.80V	+0.22(Ag/AgCl)	Ti +0.37V
Cu/Cu ²⁺	+0.34V	+0.05(Cu/Cu ₂ O)	Ag +0.30V
H ₂ /H ⁺	±0.00V	-0.414(H ₂ /H ₂ O)	Cu +0.04V
Pb/Pb ²⁺	-0.13V	-0.27(Pb/PbCl ₂)	Ni -0.03V
Ni/Ni ²⁺	-0.25V	-0.30(Ni/NiO)	Pb -0.27V
Fe/Fe ²⁺	-0.44V	-0.46(Fe/FeO)	Fe -0.40V
Zn/Zn ²⁺	-0.76V	-0.83(Zn/ZnO)	Al -0.53V
Ti/Ti ²⁺	-1.63V	-0.50(Ti ₂ O ₃ /TiO ₂)	Zn -0.76V
Al/Al ³⁺	-1.67V	-1.90(Al/Al ₂ O ₃)	

Standard potential series (electrochemical voltage series) and galvanic series for some common metals.

Galvanic corrosion occurs because of the interconnection of two metals with different electrode potential, among other causes. What happens is that aluminium hydroxide (looks a bit like flour) deposits on the aluminium next to the pipe. This coating effectively prevents the heat from the pipe from reaching the fin (the radiant surface) which, in turn, causes output loss for the ceiling heater. A condition for this process is that moisture successfully penetrates between the different materials.

It is evident from the table that you should definitely avoid mechanical connections between copper and aluminium, but also between steel and aluminium.

In certain types of premises, where a high percentage of moisture can be expected during certain periods, or where the products have to be rinsed for hygiene reasons, you should avoid using products with a mechanical connection (design 1). If moisture does penetrate between the copper/steel pipe and the aluminium fin, there is a risk of galvanic corrosion.

3. Optimizing the ceiling heater

How good the heat transfer is between the pipe and fin and how well the fin can conduct the heat can best be described with the concept of fin efficiency. Fin efficiency is a measure that describes the heat transfer losses in a fin due to unevenness in the output distribution across the surface of the fin.

It is theoretically possible to calculate the fin efficiency. Once you have the fin efficiency, you can optimise the fin thickness, the c/c distance between the pipe rows, the component materials and pipe diameters.

NOTE! The diagram applies with perfect (homogenous) contact between pipe and fin.

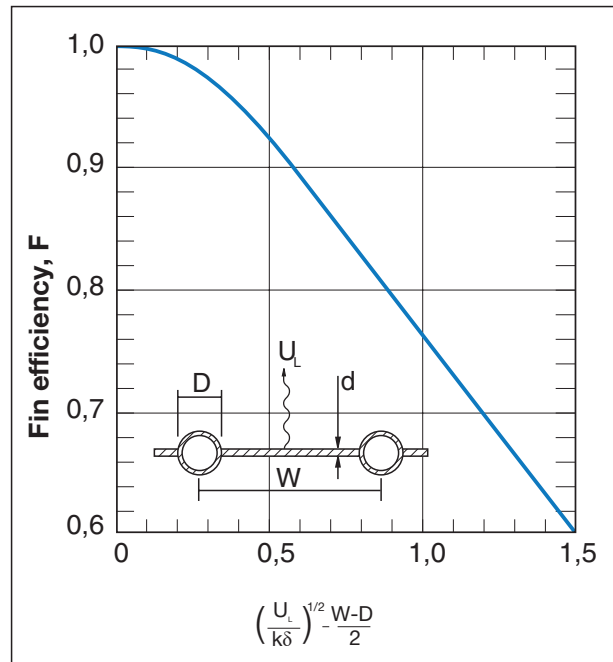

Fin efficiency for pipe and fin in homogenous contact.

Key:

- D: Pipe diameter, outer.
- d: Fin thickness
- w: c/c distance between pipe rows
- U_L: Total heat load per surface unit W/m² °C – is approx. 11 with suspended installation
- k: Thermal conductivity (coefficient of thermal conductivity)

The formula shows that increased fin efficiency can be achieved by:

1. Using materials with high thermal conductivity.
2. Thicker fin.
3. Increasing the pipe diameter (the concept of fin efficiency, however, does not take into consideration the fact that an increase in pipe diameter lowers the Reynolds number and increases the risk of switching to laminar flow, which would significantly impair the heat transfer between the water and the pipe wall).
4. Reducing the c/c distance between the pipe rows.

Ceiling Heating Guide

Thermal conductivity

To fulfil point 1 in the previous paragraph, you need to know the thermal conductivity of the relevant metals.

Material	Thermal conductivity (W/m K)
Aluminium	218
Copper	385
Steel	84
Silver	420
Gold	300
Tin	65
Nickel	88

Certain of these metals can be eliminated directly for cost reasons. The metals may be relevant for the fin as previously mentioned are – aluminium, copper or steel. The reason for selecting aluminium is obvious from the table below.

Material/Property	Weight	Strength
Aluminium	1 kg*	1 N/m ²
Copper	2 kg	0.6 N/m ²
Steel	4 kg*	6 N/m ²

**) Index = 1 for Al. The table applies for achieving the same fin efficiency, i.e. with compensated fin thickness.*

An additional reason for using aluminium is that it has very good resistance to external corrosion.

A few examples:

How is the thickness of the fin affected if you use copper or steel, respectively, instead of steel and if the fin efficiency is to remain constant?

Copper: The fin thickness can generally be halved to achieve the same degree of efficiency.

Steel: The fin thickness needs to increase by a factor of 2.5.

Pipe spacing

Pipe spacing is of importance for the heating effect attained by the product. The denser the pipe spacing is, the more even the surface temperature, and thereby, the higher the effect, or if you prefer that, the smaller the heating surface you need to install in the room. In other words, the optimum solution for heat production would be to install only hot pipes on the ceiling. For cost reasons, material + installation, this is not feasible. You should calculate instead what the optimum pipe spacing would be without the loss of too much heating effect.

4. How well is the product tested?

In those cases where the product has been tested by an independent test institute, clear proof has been shown of the product's quality and service life. Lindab Comfort's ceiling heaters have been subjected to many extreme tests. Here is a selection of these:

1. The products have been exposed outdoors for a period of ten years (in the capacity of solar collectors) to establish any corrosion risks.
2. Expansion tests. On repeated occasions, the surfaces have been exposed to a temperature of 200°C, and then shocked with 10°C water, to see if the expansion difference between the copper pipe and the aluminium fin affects the product.
3. Pressure tests. The products have been pressure-tested over 5,000 cycles at a pressure of 10 to 12 bar to ascertain material fatigue and discover any crack formation in the construction.

The last two tests were conducted at the Technical Research Institute of Sweden. In none of the cases has any quality impairment of the product been discovered.

5. Easy to install

If you can manufacture a product with a low weight that, at the same, has a stable design, you will have lower total costs (product price + installation costs) than what would otherwise be the case. Material selection, once again, is decisive for a good result. However, the construction and composition of the product will also be of importance. A low weight also provides an advantage in the form of a lower load on the ceiling structure.

6. Flexibility

Flexibility means how well the product can be adapted to new divisions in the existing premises. Flexibility has a great significance for the property owner, who will rent the building to several tenants during its service life, or if there should be changes to the layout of the premises. The climate system should not place restrictions on the type of activity for which the premises are intended. If the premises have been used as a warehouse, the climate system should not be an obstacle to modifying the premises to make them suitable for a manufacturing industry where, for example, machinery will have to be anchored to the floor. It should be easy to move and relocate the products across the ceiling to the place where they are needed the most. A prerequisite for this is prefabricated units that are easy to connect and interconnect.

Ceiling Heating Guide

7. Product finish

As regards finish, it is the surface treatment that is of decisive importance. Automated production with well-implemented preparatory work and a stove-enamelled surface provides a high-quality finish.

8. Product structure

To obtain the intended effect from the ceiling heater, the surface should be smooth, to prevent unnecessary air movement (convection). The share of radiation should be as high as possible to attain the intended effect - both with regard to comfort and operating costs. Insulation of the top surface should be good enough to concentrate the heating effect to the underside of the ceiling heater.

Products entirely of aluminium

These types of products, where both the pipe and fin are of aluminium, occur rarely. This is due to the obvious risk of corrosion that exists when water is led through an aluminium pipe.

This type of corrosion is called pitting and always occurs, and very quickly, when water is led through an aluminium pipe – the risk of leakage is expected to appear within a matter of days. To counteract this type of corrosion, so-called inhibitors are added to the water, i.e. different types of chemicals that slow down the corrosion process. The problem with inhibitors is that they are used up continuously and therefore must be added continuously to eliminate the risk of corrosion. If the inhibitor concentration drops too low, the inhibitor can do more damage than good - it can accelerate the corrosion process.

Ceiling Heating Guide

Chapter V

Placement of the ceiling heater

The fundamental rule when positioning ceiling heaters in a room or a building is that ceiling panels should be distributed as evenly as possible. Moreover, the panels should be placed in relation to the heat losses of the surrounding surfaces, i.e. more heat-emitting surface should be positioned near façade and window surfaces, partly, to cover the heat losses and, in part, to heat the window surfaces, thereby counteracting possible draughts.

When selecting a ventilation system or positioning air units, you do not need to take the ceiling heating system into consideration. Ceiling heating itself does not cause any air movement. References [10] and [11] have investigated air movements in rooms with ceiling heating. In summary, the results show that only minor air movement is detected in these rooms. It is only near a cold outer wall that air velocities in excess of 0.03 m/s can be recorded. The air velocities that normally occur in a room, 0.1 to 0.2 m/s, are caused by ventilation and convective air movements due to people and hot equipment.

Instructions are given here for the theoretical ideal placement of the heating panels. However, in reality there are often obstacles preventing the ideal placement of the heating panels. There may be ceiling beams or other structures on the ceiling, light fittings or other installations that are in the way. Besides, you can decide to slash piping costs by simplifying the distribution of the heating panels, and thus not achieve the ideal placement.

It is important to point out that the instructions give recommended values. However, if it is not possible for practical reasons to reach the recommended values and the deviation from these is significant, you should contact us to ensure that there will not be any problems.

If the deviation is smaller, the results will probably be satisfactory in most cases. People are not so sensitive that they experience discomfort with the small differences in thermal radiation that would occur if the recommended distribution cannot be achieved.

You should nevertheless strive to follow the following rules of thumb so as to achieve as uniform distribution of thermal radiation as possible.

Against outer walls without windows, the panel closest to the wall should be placed, as follows:

With the indicated distance from the outer wall and different ceiling heights, the thermal radiation distribution is approx. 60 to 70% to the outer wall and approx. 30 to 40% to the floor, which corresponds to the approximate transmission loss distribution along an outer wall and the inner and outer edge zone of the floor, which are covered by a ceiling heating panel/heating strips. Strips or panels do not normally need to be angled to direct thermal radiation, for example, towards the outer wall. Normal spacing between ceiling heaters is assumed, according to what is given below.

Against an outer wall with windows: If the outer wall contains standard or large glass surfaces, the panels can be positioned closer to the wall.

The heating effect should be concentrated so as to lower the risk of draughts and to reach the required operative temperature values. Concentration is rarely needed with smaller windows. It is difficult to give rules of thumb in these cases, as there are significant variations in window size and building designs.

Spacing between panels/strip is evident from the diagrams below. The recommended spacing between panels/strips is presented as a function of the installation height. With the recommended spacing, the amount of thermal radiation is the same both between the heaters and beneath them, i.e. thermal radiation is distributed as uniformly as possible.

Ceiling Heating Guide

Chapter V

Placement of the ceiling heater

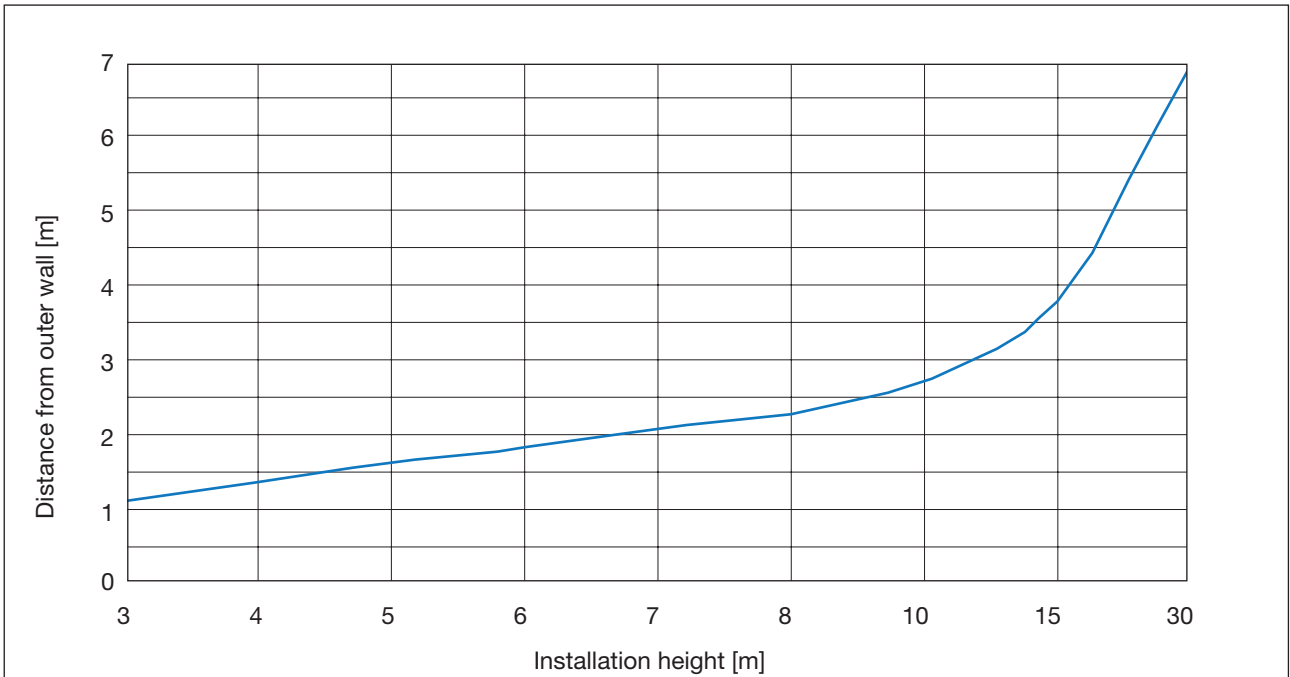

Recommended distance between the ceiling heater, closest to the outer wall, and the outer wall (without window).

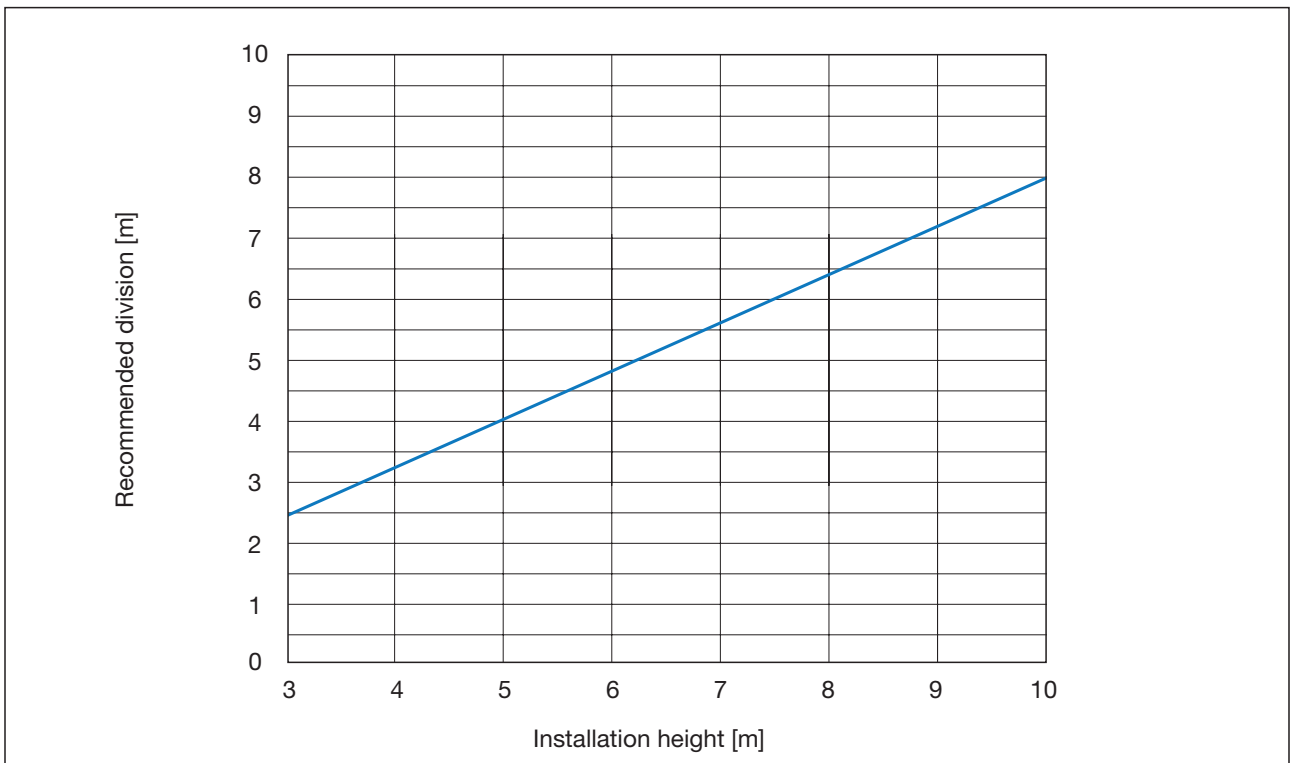

Recommended distance between panels with ceiling heating.

Ceiling Heating Guide

Chapter VI

Temperature and necessary installation height

The temperature of the ceiling heaters, i.e. the temperature in the heating system, affects the effect, a subject we take up in Chapter VII. However, it also affects the experience of heat from the ceiling heaters. The question "Will my head be too hot?" is common. In this chapter, we review the factors for how the ceiling heater's temperature and installation height affect the experience of the climate.

It is the building's installations and heat source, the quantity and size of the ceiling panels, ceiling height, radiant temperature asymmetry and operative temperature that are affected or affect the temperature level. In this context, it is important to point out that the heating system does not require a higher temperature level, the greater the height of the ceiling. The reason for this was presented in Chapter II.

A selected temperature is most often used as basis and then, you determine, just as with conventional heating systems, the quantity and size of the ceiling heating panels needed to meet the design heating effect requirement (refer to Chapter VII). Certainly, the quantity and size should be combined so as to distribute the ceiling heating panels across the area of the premises (refer to Chapter V). Besides, you should also check the radiant temperature asymmetry and the directed operative temperature to see if these values are prescribed.

When the ceiling panels are distributed based on the heating effect requirement, the geometry of the premises and with regard to furnishings and other installations, you should check the radiant temperature asymmetry (RTA). RTA is defined as the difference in plane radiant temperature on each side of a small flat surface (also refer to Chapter I). The plane radiation temperature is calculated using the measured surface temperatures and angle factors or is measured with a radiation temperature meter. RTA is measured in a plane of 0.6 m above floor level when sitting or 1.1 m above floor level when standing. The Swedish Indoor Climate Institute [8] and ISO standard 7730 indicate that the RTA should be a maximum of 5°C with ceiling heating.

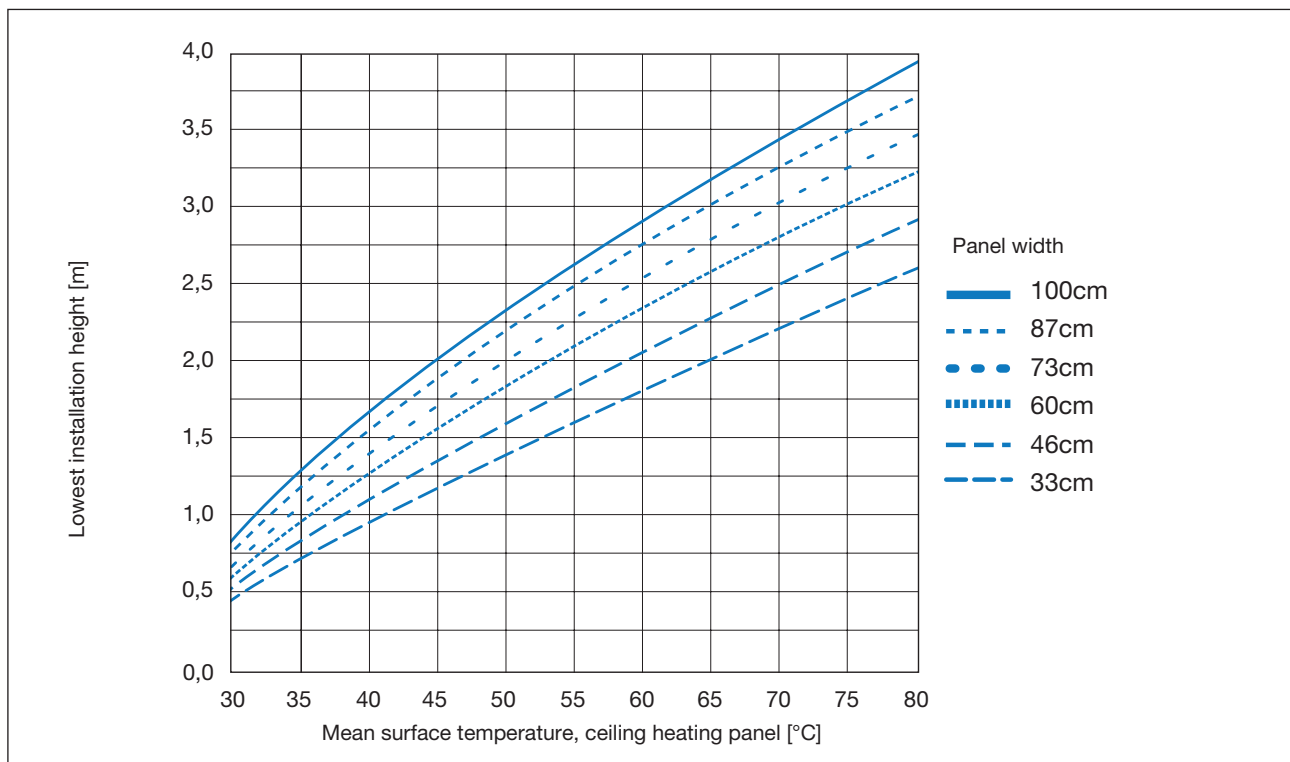

Lowest installation height for ceiling heaters with radiant temperature asymmetry of 5°C. Ceiling heater length 3.6 m.

Ceiling Heating Guide

The RTA is normally calculated directly below a ceiling heater and depends on the installation height, surface temperature and size of the ceiling heater and on the temperatures of other surrounding surfaces. To avoid extensive calculations, we present the diagram below, which indicates the lowest allowed installation height so that RTA does not exceed 5°C. The different curves represent different ceiling panel widths. The different diagrams apply for different ceiling panel lengths (3.6 m and 10 m). The presentation of these curves presupposes that all surrounding surfaces have the same temperature.

This is rarely the case in reality. In most cases, the RTA will be more favourable. Normally, there are one or more cold windows, and the floor is usually warmer than the surrounding walls with ceiling heating. This means that the RTA falls as the window(s) are most often above the measurement plane and thereby compensate for the warm ceiling panels. The warm floor also contributes to raising the plane radiant temperature under the measurement plane, which reduces the RTA. In total, the RTA will be less than 5°C if the ceiling heaters are installed at a height indicated in the diagrams.

In this connection, it is important to point out that, we are talking about here about design heating temperatures that statistically occur only a few days per year. During most of the year, the RTA with ceiling heating is less than 5°C.

In summary, we can ascertain that the smaller the surface (shorter and/or narrower) of the panels, the lower they can be installed without exceeding the stated radiant temperature asymmetry.

In [1], skin temperature measurements were taken, and the experienced comfort level of 15 test subjects was recorded in a room with ceiling heating. In summary, we can establish that there was no significant difference in skin temperature for the head and the rest of the body than normal. As regards the comfort experience, there were small differences in the comfort results between the head and feet. The difference, however, is not greater than what would be caused by other heating systems.

During our own measurements of radiant temperature asymmetry, the values were between 1.0 and 5.5°C in different premises, e.g. schools, day-care centres, showrooms, offices and industrial premises. Most values were around 2 to 3°C. The higher value (5.5°C) was measured in a workshop where the door was opened frequently which, in turn, lowered the floor temperature.

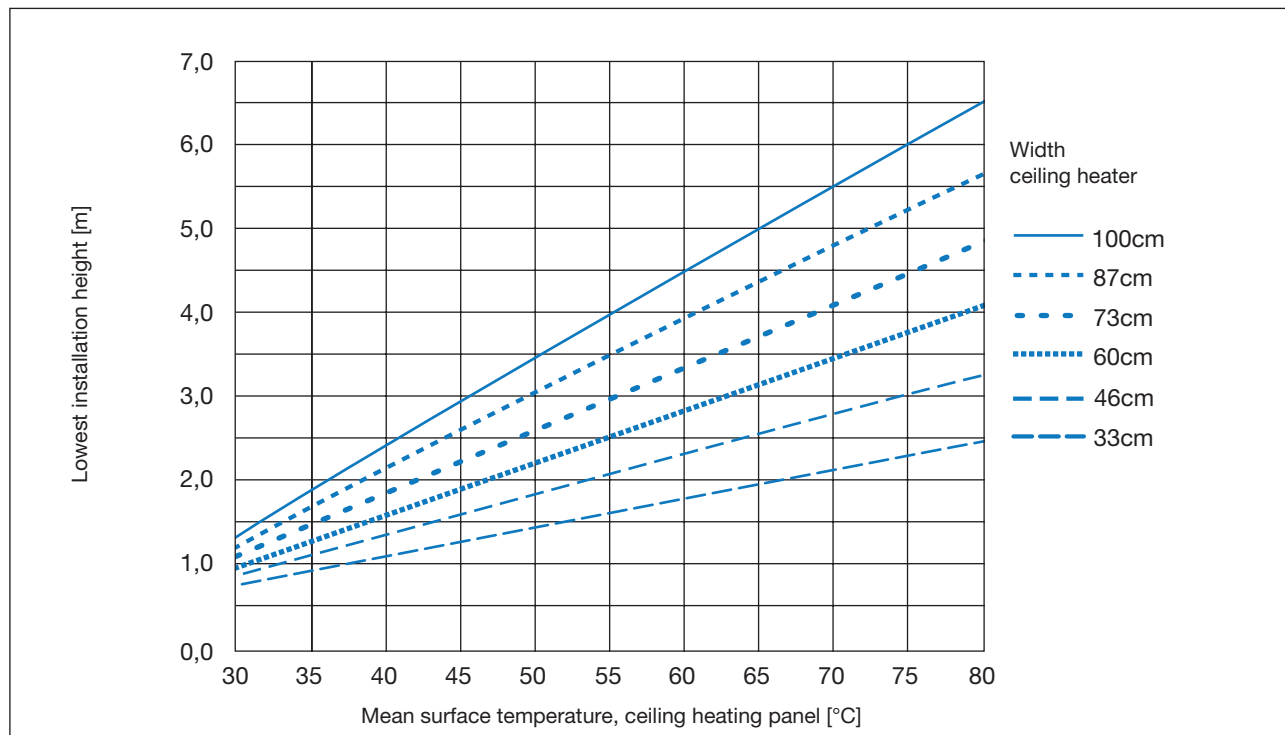

Lowest installation height for ceiling heaters with radiant temperature asymmetry of 5°C. Ceiling heater length >10 m.

Ceiling Heating Guide

Zone heating

Ceiling heating offers a special advantage when heating a certain part or a certain zone in a building. You can maintain a low air temperature in the premises, but raise the operative temperature locally in those areas where people work/stay. The higher temperature of the ceiling heater and the heating of the floor allow the operative temperature to be raised well above the air temperature.

In the diagrams below, the operative temperature is presented as a function of the installation height. These show cases of air temperatures of 10 or 15°C, respectively. Walls and ceilings are assumed to have the same temperature as the air, whereas the floor is heated to a temperature of approx. 2°C above the air temperature. The different curves represent ceiling heater widths of 0.6 m and 1.2 m, respectively, with two different system temperatures, 55/45 and 80/60°C, respectively.

Operative temperature with zone heating

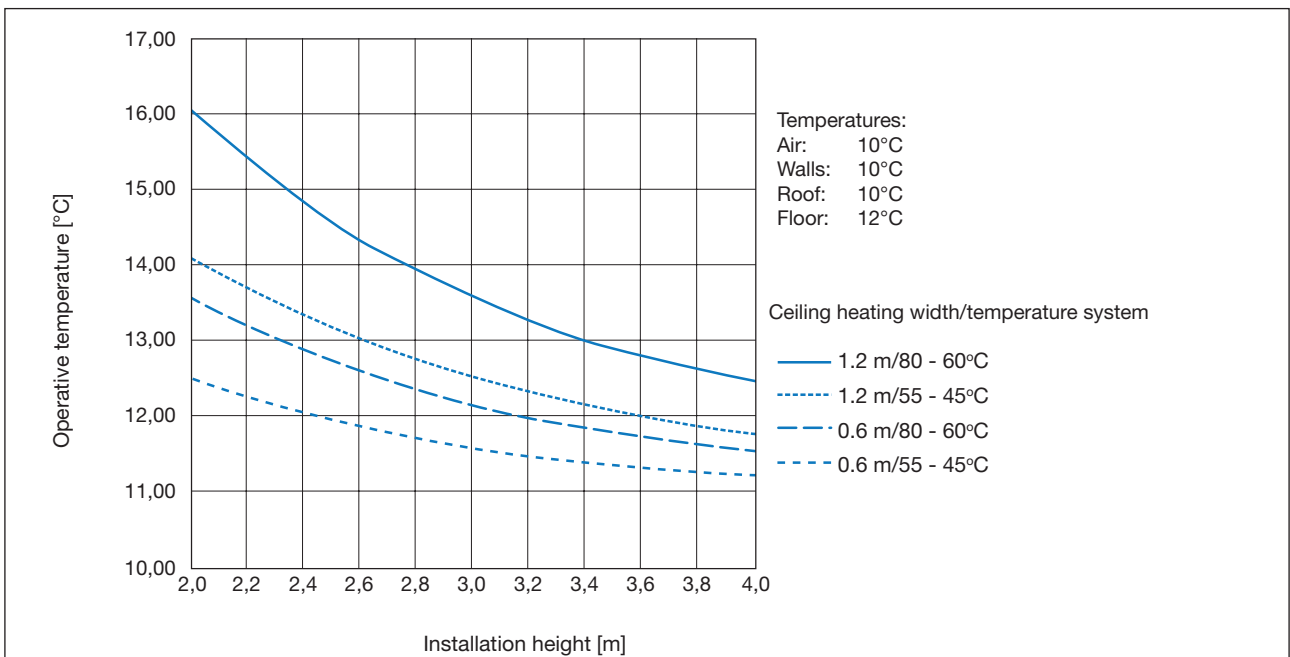
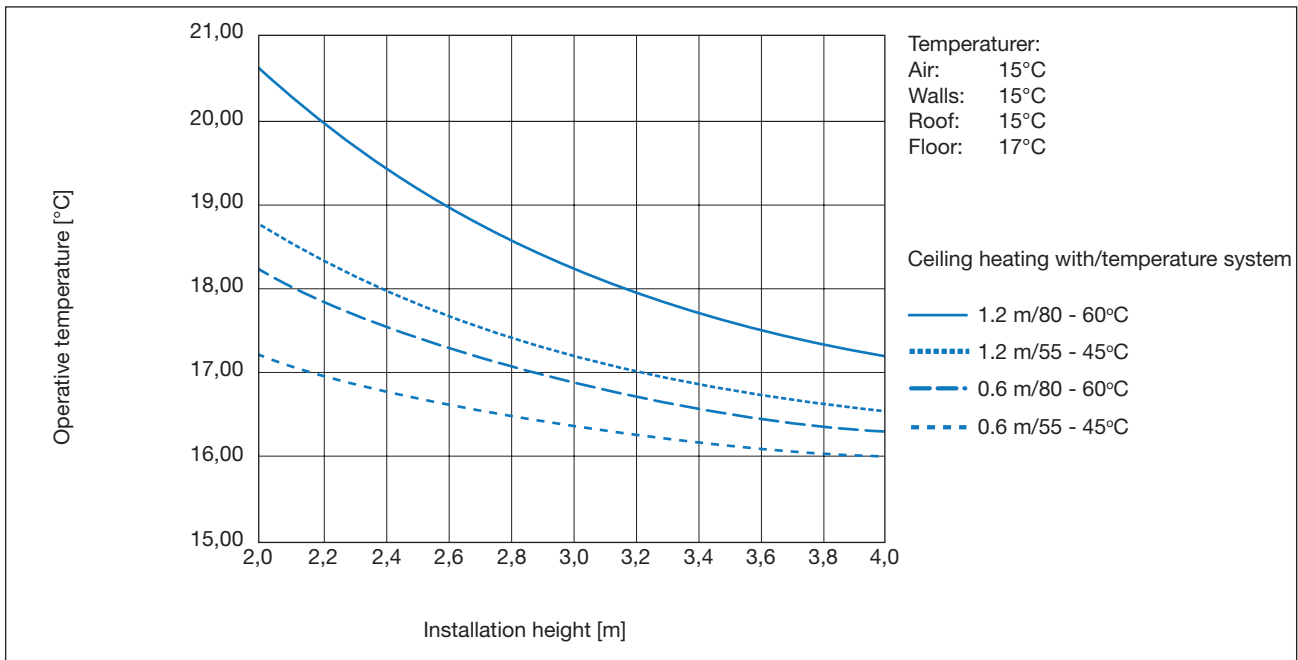

Ceiling Heating Guide

Chapter VII

Effect and energy

As previously mentioned, when calculating the design heating effect requirement, the different parts of the building are calculated first with regard to area and total heat transfer coefficient, Up value, and then Umean. This is normally calculated according to the existing building regulations BBR 94, Heat Insulation (Boverket) and Swedish Standard (SS 02 42 02 and SS 02 42 30).

When the design outdoor temperature (DOT) is to be determined, the method described in Swedish Standard (SS 02 43 10) is used to avoid over-dimensioning of the heating system. The method is based on taking the room's/building's individual time constants, i.e. heat storage abilities, into consideration, and then calculating the DOT for each building or room.

When calculating the heating effect requirement in a new building, you can usually assume an indoor temperature for ceiling heating that is one to two degrees lower than normal. This reduction, however, is only an empirical value, and during planning, you should check the sensitive parts of the building with regard to operative temperatures or other prescribed climatic factors that are temper-

ature-dependent. The fact that a reduction in temperature is normally possible is due to the thermal radiation from the ceiling heating up the surrounding surfaces, e.g., the floor, walls and furnishings. Individuals then experience a reduction in the thermal radiation given off by their bodies. In this way, the room air temperature can be lowered by as much as the mean temperatures of the surrounding surfaces have increased, and yet maintain the correct comfort level. This applies provided that other climatic factors are kept at a constant level, and the air velocity does not exceed 0.15 m/s.

As soon as you introduce a heat source into a room and maintain a temperature above the outdoor temperature, there will be a temperature gradient in the room because of density differences between warm and cold air. The gradient is not as large in all places. It is especially near the floor and ceiling and especially the outer walls that the gradient can be non-linear. In other parts of a room, the temperature gradient is most often virtually linear. The magnitude of the temperature gradient varies with the position in the room, the temperature of the room surfaces, the room's ventilation and size, the number and placement of the heaters, involuntary ventilation, the furniture and the activity in the room [12]. As you can see, there are a number of factors that have an effect; however, quite a lot of them have a small or a very small effect on the temperature gradient.

$$P_{dim} = P_t + P_{ov} + P_v$$

where P_t = Effect requirement due to transmission

P_{ov} = Effect requirement due to involuntary ventilation.

P_v = Effect requirement due to ventilation

The effect supplied by internal generation in the building or room is not normally included in the calculation, if it cannot be regarded as a constant heat source.

The effect requirement due to transmission is calculated according to:

$$P_t = \sum_i U_i \times A_i \times \Delta t_i$$

A_i = The area for each part of the building (m²).

U_i = U_p value for each part of the building (W/m² °C).

Δt_i = Temperature difference for each part of the building, i.e. when calculating each part of the building, the temperature gradient is taken into consideration. You do not need to take the temperature gradient into consideration for low ceiling heights (approx. 2.5 to 3.5 m).

Effect requirement due to involuntary ventilation, P_{ov} , is normally assumed to be:

- Older homes: 0.4-0.6 oms/h
- Newer homes: 0.2-0.4 oms/h
- Older commercial or public premises: 0.3-0.5 oms/h.
- Newer commercial or public premises: 0.1-0.3 oms/h.

Effect requirement due to ventilation is calculated according to:

$$P_v = q \times \rho \times c_p \times \Delta t_v$$

where q = airflow outdoor air (m³/s)

ρ = air density (kg/m³)

c_p = air heating capacity

Δt_v = temperature difference between outdoor temperature and supply temperature.

The design effect requirement for heating is calculated according to the formula above.

Ceiling Heating Guide

A ceiling heating system's effect on the temperature gradient is favourable. The surrounding room surfaces are heated by the thermal radiation and, in turn, give off heat, partly through radiation (secondary) to other surfaces, and partly by convection to the air. Combined, this means that the air is heated extremely evenly towards all the room surfaces. The result is a relatively small temperature gradient.

As indicated above, there are several factors other than the heating system that affect the size of the temperature gradient. The size of the gradient therefore is different from one building to another depending on the conditions in the building. In the measurements we have made ourselves, the temperature gradient in premises with ceiling heating and ceiling heights between 2.8 m and approx. 7 m is between 0.3 and 1.0°C/m with a cluster at 0.4 to 0.5°C/m.

Ref. [12] lists the values for other heating systems; these are retrieved from the international literature:

- radiator systems: 1 to 2°C/m
- convective heating: 2 to 3°C/m

As previously mentioned, at higher ceiling heights, the temperature gradient plays a significant role when calculating the design heating effect requirement. In rooms with normal ceiling heights (approx. 2.5 m), the temperature gradient plays a relatively small role for the effect requirement. Below, there are examples of the influence the temperature gradient has at relatively high ceiling heights in different scenarios. The values below are calculated theoretically and are based on the following example:

A hall in the area of Gothenburg, $DOT_{10} = -10^{\circ}\text{C}$, with a floor area of 500, 1000 and 2000 m², respectively, and window area equal to 10% of the floor area.

The Up value for the wall is 0.2, for the ceiling 0.2 and for the floor 0.3 W/m², °C.

The windows' Up value is set to 2.0 W/m², °C. Involuntary ventilation is assumed to be 0.3 oms/h. The heating effect requirement concerns only transmission and involuntary ventilation.

The effect requirement for each row is indexed against the case room temp./gradient: 20°C/0.0°C/m for the respective row. The figures can only be compared with each other on the same row.

Relative heating effect requirement

The energy requirement for the heating comes from three factors: transmission, ventilation and involuntary ventilation. Transmission normally stands for approx. 20 to 50% and ventilation, including involuntary ventilation, for 50 to 80%. In a property heated to normal indoor temperatures (approx. 20°C), it is often said as a rule of thumb that you save approx. 5% of the energy consumption, per degree drop in the indoor temperature.

With a ceiling heating system, the indoor temperature can normally be lowered by one to two degrees, without lowering the operative temperature below that allowed [4]. Furthermore, the temperature gradient is lower with ceiling heating than with conventional heating systems.

As a result of these two factors, the losses due to transmission (especially through the ceiling) and, in particular, due to ventilation and involuntary ventilation decrease. In [3], the difference in measured energy consumption between a ceiling heating system and a radiator system is stated to be 2 to 7% in favour of ceiling heating. In a literature study [4], the energy savings with ceiling heating are measured as 6 to 30% in different premises.

A theoretical comparison of energy consumption between different systems, presented as different temperatures and different temperature gradients, is shown on page 4:33. The same premises and conditions have been used as in the comparison with design effect requirement. The energy consumption has been calculated with the degree-day method. The indicated temperature gradient is assumed to occur with the design outdoor temperature (-10°C), to then drop linearly to zero when the outdoor temperature and room temperature are equal.

The energy requirement for each row is indexed against the case room temp./gradient: 20°C/0.0°C/m for the respective row. The figures can be only compared with each other on the same row. (see table 1).

Relative heating energy requirement

The table shows that the difference between different heating systems, or alternatively, the temperature relation, results in a difference in energy consumption that approximately corresponds to the measured economies that ceiling heating gave in the above references. It is obvious that the amount of energy savings varies depending on the conditions. Nevertheless, it is quite clear that a ceiling heating system provides an energy consumption that is lower than that for most other heating systems. (see table 2).

Ceiling Heating Guide

Table 1 – Relative heating effect requirement

		Room temp./gradient (°C and °C/m, respectively)				
Area (m ²)	Ceiling height (m)	20/0.0	20/0.5	20/2.0	18/0.5	18/0.2
500	5	1.00	1.04	1.17	0.96	1.09
	10	1.00	1.08	1.33	1.01	1.26
1000	5	1.00	1.04	1.18	0.97	1.10
	10	1.00	1.09	1.35	1.02	1.28
2000	5	1.00	1.05	1.18	0.97	1.11
	10	1.00	1.09	1.35	1.02	1.29

Table 2 – Relative heating energy requirement

		Room temp./gradient (°C and °C/m, respectively)				
Area (m ²)	Ceiling height (m)	20/0.0	20/0.5	20/2.0	18/0.5	18/0.2
500	5	1.00	1.04	1.17	0.89	1.01
	10	1.00	1.09	1.34	0.94	1.18
1000	5	1.00	1.04	1.17	0.89	1.01
	10	1.00	1.09	1.34	1.94	1.18
2000	5	1.00	1.04	1.17	0.89	1.01
	10	1.00	1.09	1.34	0.94	1.18

Ceiling Heating Guide

Chapter VIII

Environment and recycling

Life cycle analyses (LCA) that have been produced for aluminium products show many common features. The material's production stage (mining, concentration and production) contributes a relatively high load factor to both energy and environment. Compared to other materials, the reverse is observed in the product utilisation phase. The load for aluminium products in the production stage is sometimes fully compensated by their lower impact on the environment in the utilisation phase.

Moreover, if the aluminium is recycled, the impact on the environment from the production stage is further reduced to a corresponding degree.

Lindab Comfort's ceiling heating systems consist exclusively of copper, aluminium, an insulating sheet of expanded polystyrene and a small amount of tin solder. All component materials, except for the insulating sheet, are up to 100% recyclable. All production waste goes for recycling, even today.

When a building, where Lindab Comfort's ceiling heating products are installed, is demolished, 100% of the metals they contain can be recycled. Certainly, the aluminium and copper are bonded metallurgically in the manufacturing process and cannot be separated, but nevertheless recycling is still possible. The ceiling heaters are pressed in a package of approx. 20 × 20 cm and are used in the metal industry as alloying materials for different aluminium qualities. The proportion of copper is well defined in each of the packages, as each centimetre of a panel contains the same percentage of copper.

[20] presents life cycle assessments (LCA) for different packaging materials, e.g. aluminium and sheet steel. A comparison between these materials is presented below, without recycling and with 70 to 75% recycling. The presented values are not translatable to Lindab Comfort's ceiling heating products, since LCA applies only for a specific product and its special conditions during its service life. The absolute values are therefore not applicable to Lindab Comfort's products.

What we wish to show with the diagrams on this and the next page, however, is that the load on the environment falls dramatically with a good degree of recycling and that aluminium, from an environmental aspect, is equal to sheet steel with 70 to 75% recycling. Nowadays, the degree of recycling is low when a house is demolished, but in the future, developments in this area will probably go quickly and then, recycling degrees of 70 to 75% will not be unusual. For this reason, you can assume with great certainty that the products from Lindab Comfort installed today will be recycled when the building they are installed in is demolished or rebuilt.

Discharge of different substances

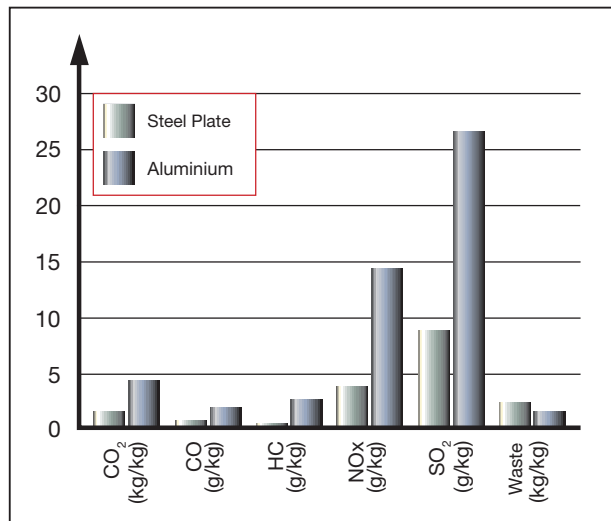

LCA values for packaging without recycling.

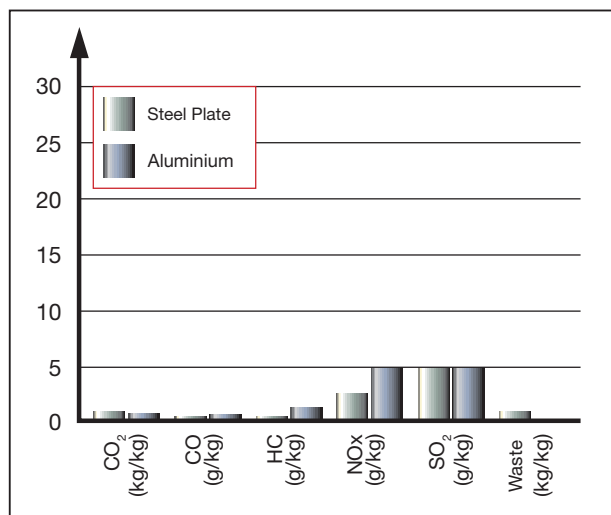

LCA values for packaging with 70 to 75% recycling.

Ceiling Heating Guide

Use of different types of energy

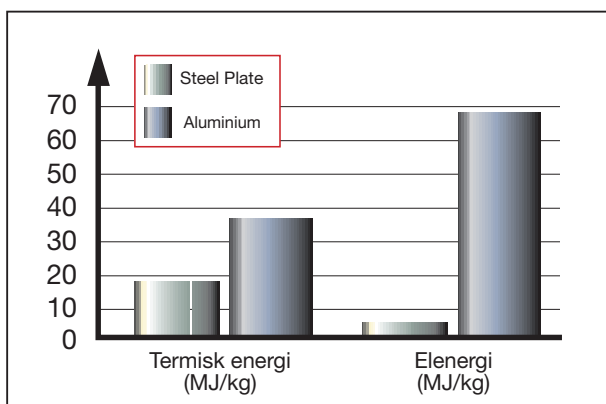

LCA values for packaging without recycling.

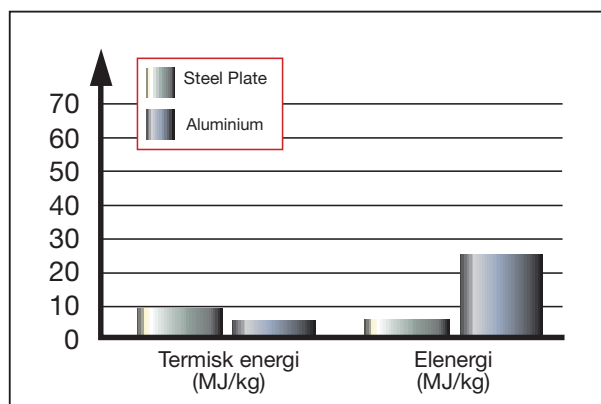

LCA values for packaging with 70 to 75% recycling.

References

- [1] damsson/Löfstedt: Takvärme, Temperaturfördelning och behaglighet, (Ceiling heating, Temperature distribution and Comfort): The Swedish Institute for Building Research, Report R12:1971, 1971.
- [2] Lind/Olsson: Klimatmätningar i skolor med elektrisk takvärme och fläktstyrd frånluftsventilation (Climate measurements in schools with electric ceiling heaters and fan controlled exhaust ventilation): The Swedish Institute for Building Research, Report R40:1972, 1972.
- [3] Johansson/Pettersson: Takvärme – energiförbrukning och inomhusklimat (Ceiling heating – energy consumption and indoor climate): The Swedish Institute for Building Research, Report R12:1984, 1984.
- [4] Brännvall: Takvärme – kritisk granskning av olika uppvärmningssystem, litteraturstudie: (Ceiling heating – critical review of different heating systems, literature study) KTH Inst. for Heating and Oven technology, Stockholm 1977.
- [5] Jacobsson/Lindgren: Kallras vid fönster – en förstudie (Draught by windows – a pilot study): Wahlings installationutveckling AB, Stockholm 1982.
- [6] Peterson: Kallras vid konvertering (Draught with convection): KTH Inst. for Heating and Ventilation Technology, A4-series no. 140, Stockholm 1991.
- [7] Al-Bazi: Klimat och byggnader nr 1/1989 (Climate and buildings no 1/1989): KTH Inst. for Heating and Ventilation Technology, Stockholm 1989.
- [8] SCANVAC, Classified indoor climate systems, guide lines and specifications: Swedish Indoor Climate Institute, Guideline series, R1.
- [9] Allard/Inard/Simoneau: Experimental study and numerical simulation of natural convection in a room with heated ceiling or floor: ROOMVENT '90 Engineering Area- and Thermodynamics of Ventilated Room, second international conference, Oslo 1990.
- [10] Krause: Die konvektive Wärmeabgabe von Heizdecken: Gesundheit-ingenieur no. 10 and 11, 1959.
- [11] Müllejan: Über die Ähnlichkeit der nichtisothermen strömung und den Wärmeübergang in Räumen mit Strahlüftung: Forschungsberichte des landes Nordrhein-Westfalen, no. 1656, 1966.
- [12] Peterson, F: Temperaturgradienter vid olika uppvärmningssystem (Temperature gradients with different heating systems): Technical Notice no. 65, KTH Inst. for Heating and Ventilation Technology, 1975.
- [13] Pierre, B: Mekanisk Värmeteori del 2 (Mechanical Heating Theory part 2) Kompendium, Institution for Mechanical Heating Theory and Cooling Technology, KTH 1979.
- [14] Duffie, J, Beckman, W: Solar Engineering of Thermal Processes: Wiley & Sons 1980.
- [15] McIntyre, D. A.; The Thermal Radiation Field; Building Science Vol 9, 1974.
- [16] McIntyre, D. A, Griffiths I. D.; The effect of uniform and asymmetric thermal radiation on comfort; Proc. of the 6th international congress of climatistics "clima 2000", Milan, March 1975.
- [17] Chrenko, F. A.: Heated ceilings and comfort; Journal of the Inst. of Heating and Ventilation Engineers, January 1953.
- [18] Olesen B. W. et al.: Thermal comfort in a room heated by different methods: ASHRAE transactions, vol 86 part one, 1980.
- [19] Fransson, J et al.: Utvärdering av Bo-klimat och fuktstyrning I Falun: Swedish Committee for Building Research, SPAR 1993: 67.
- [20] Tillman A-M. et al.: Packaging and the environment- Life-cycle analyses of selected packaging materials – Quantification of environmental loadings; Chalmers Industrial Technology, Gothenburg 1992.
- [21] Fanger P.O.: Thermal Comfort, Analysis and Applications in Environmental Engineering; Danish Technical Press, Copenhagen 1970.

Ceiling Heating Guide

Dimensioning key

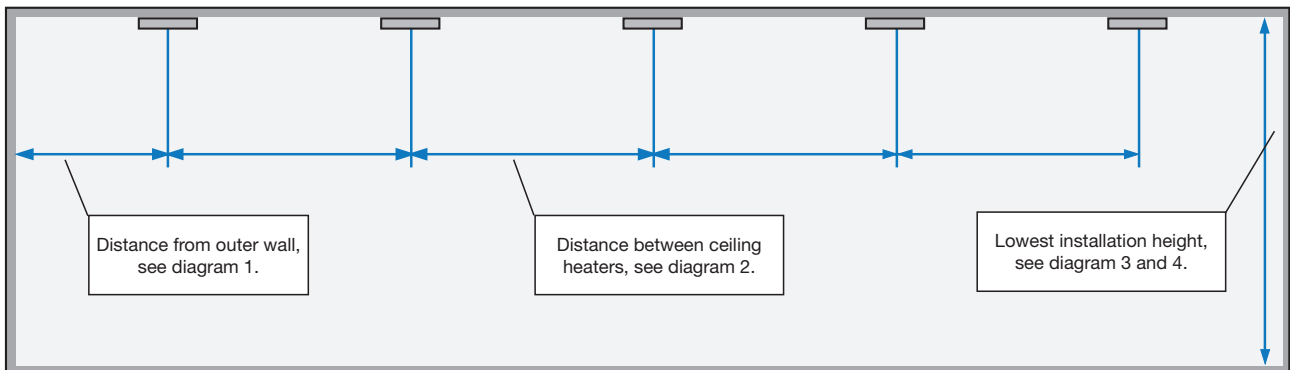

Placement of the panels

You should try to follow the following rules of thumb so as to achieve as uniform distribution of thermal radiation as possible.

Against outer walls without windows, the panel closest to the wall should be placed as shown in diagram 1.

Against an outer wall with windows: if the outer wall contains standard or large glass surfaces, the panels can be positioned closer to the wall. The heating effect should be concentrated so as to lower the risk of draughts and to reach the required operative temperature values. Concentration is rarely needed with smaller windows. It is difficult to give rules of thumb in these cases, as the variations in window size and building designs are big.

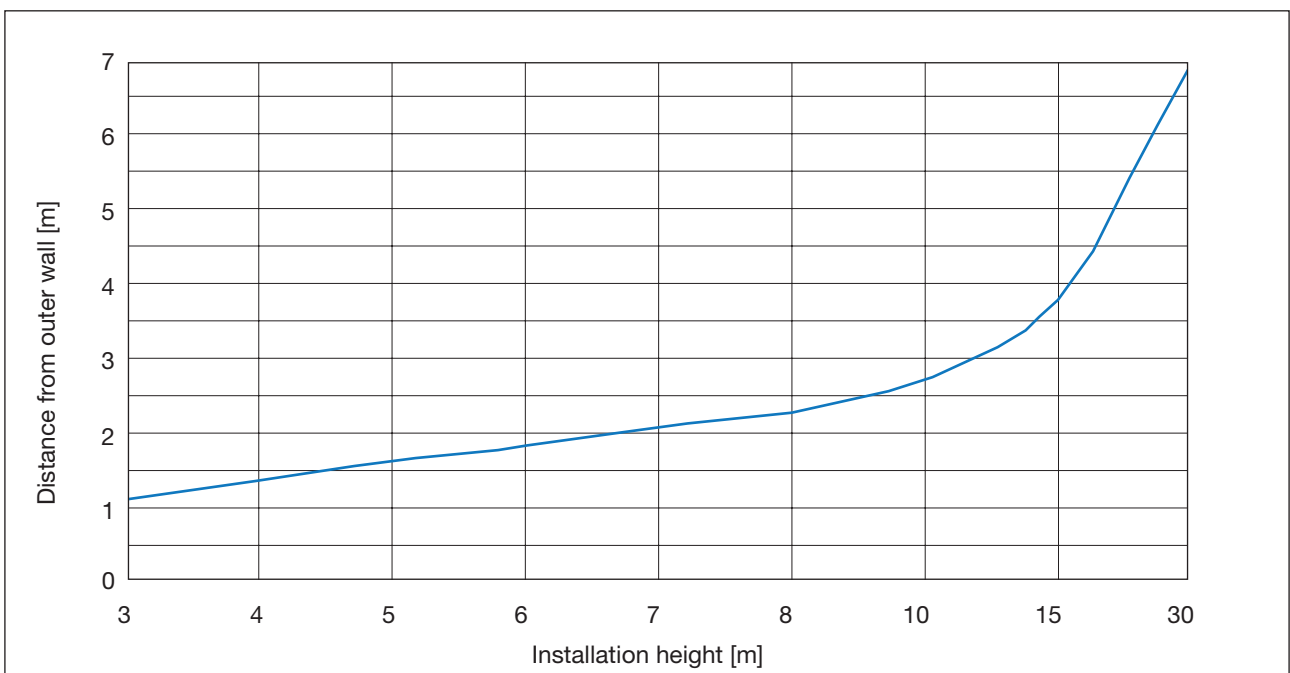

Diagram 1. Recommended distance between the ceiling heater closest to the outer wall and the outer wall (without window).

Ceiling Heating Guide

Placement of the panels

The spacing between panels/strips is clear from figure 2. The recommended spacing between panels/strips is presented in the diagram as a function of the installation height. With the recommended spacing, the thermal radiation is the same both between the heaters and beneath them.

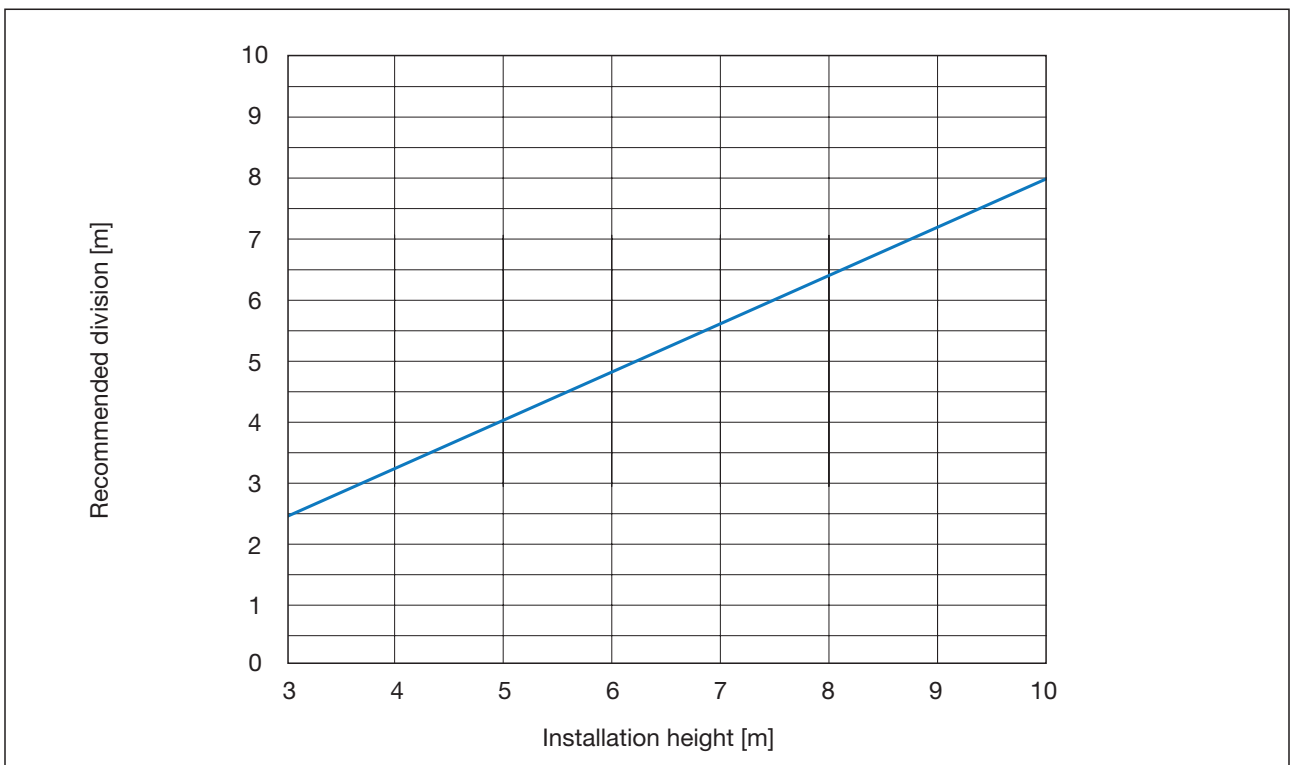

Diagram 2. Recommended distance between panels with ceiling heating.

Ceiling Heating Guide

Dimensioning key

Installation height and temperature

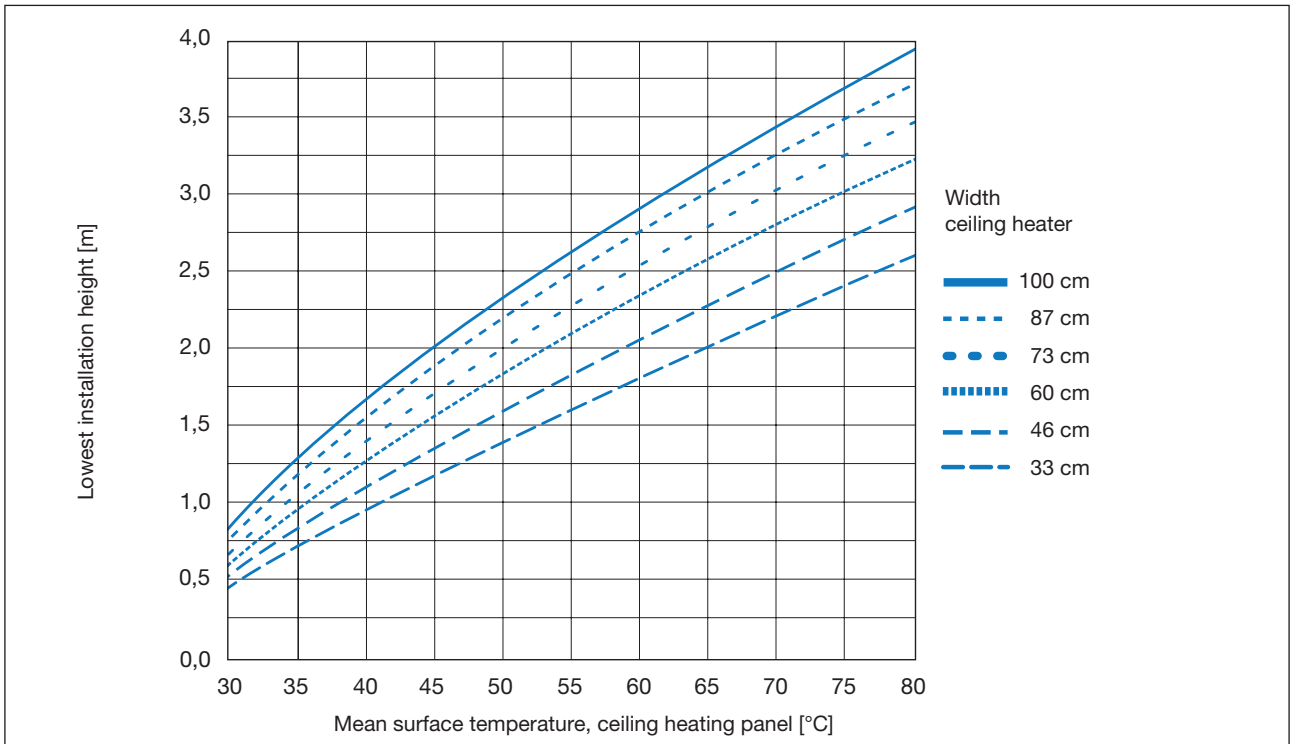

Diagram 3. Lowest installation height for ceiling heaters with radiant temperature asymmetry of 5°C. Ceiling heater length 3.6 m.

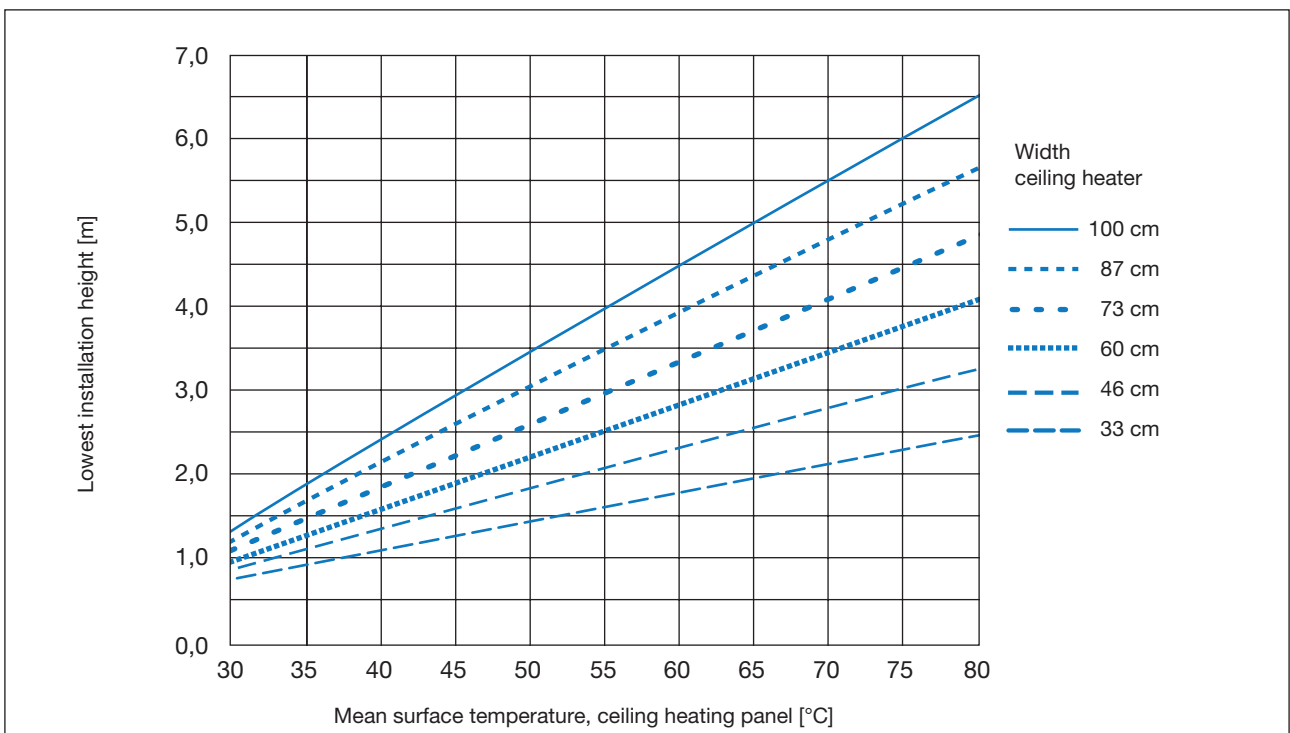
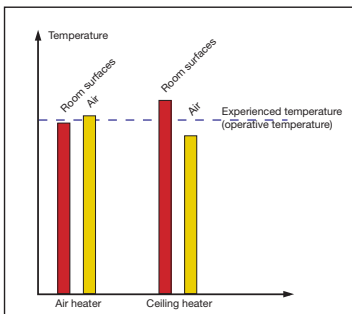

Diagram 4. Lowest installation height for ceiling heaters with radiant temperature asymmetry of 5°C. Ceiling heater length >10 m.

Ceiling Heating Guide

Quick facts



Ceiling heating heats the surfaces of the room via thermal radiation. The surfaces, in turn, heat the air. This provides the preconditions for a very good indoor climate.

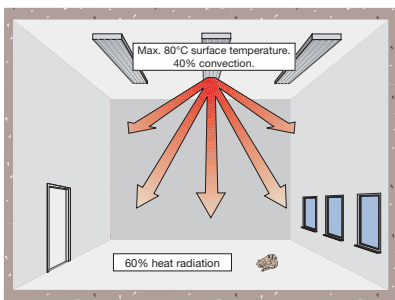

The ceiling height is of no importance for the heat transfer to the entire premises. The ceiling heater's temperature, therefore, does not need to be higher at higher ceiling heights.

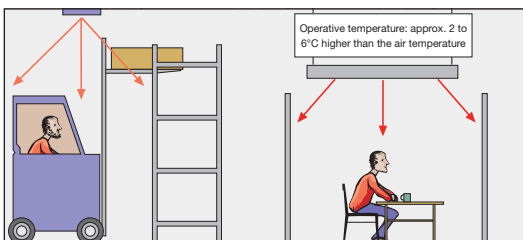

Ceiling heating also works perfectly for zone heating in larger premises. Heating of the adjacent surfaces and the ceiling heater itself means that the operative temperature can be increased by at least 2 to 6°C above the air temperature.

It will not be cold under a table, as the thermal radiation radiates indirectly from all surfaces in the room. All surfaces in the room contribute to the heating either by absorbing thermal radiation, being heated and radiating the heat, or by reflecting it.

Your head will not be too hot. Lindab Comfort's ceiling heaters are waterborne with a standard max. temperature of approx. 40 to 60°C, and are usually installed at an installation height of over 2.5 m. As a result, the thermal radiation from the ceiling heaters is barely noticeable.

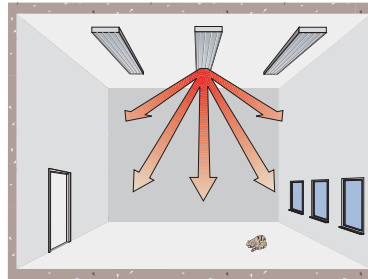

Ceiling heating is indirect floor heating! Radiant heat normally makes the floor 2 to 3°C warmer than the air directly above the floor.

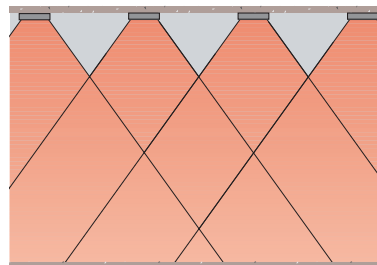

Thermal radiation spreads to all parts of the room that the ceiling heater can "see". Most radiation goes downwards and diminishes towards the sides. Thermal radiation is also guided, depending on the temperature of the recipient.

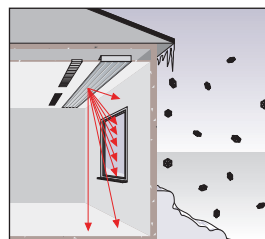

The effect from thermal radiation increases towards colder surfaces. This means that the heat goes directly to where it is needed the most, e.g. it warms the inside of windows so that the risk of draughts is eliminated.

Ceiling heating is among the most energy-efficient heating systems available. Ceiling heating allows 1 to 2°C lower room temperatures and gives a very small temperature gradient in the premises, i.e. no heat cushions are formed by the ceiling.

Ceiling-heating systems can be modified easily when the activity is changed. You do not need to take the ceiling system into consideration when modifying the walls and floor.



Most of us spend the majority of our time indoors. Indoor climate is crucial to how we feel, how productive we are and if we stay healthy.

We at Lindab have therefore made it our most important objective to contribute to an indoor climate that improves people's lives. We do this by developing energy-efficient ventilation solutions and durable building products. We also aim to contribute to a better climate for our planet by working in a way that is sustainable for both people and the environment.

[Lindab](#) | For a better climate