

Nozzle diffuser

DCS



Description

DCS is a circular diffuser with integrated box for visible installation. The diffuser is equipped with individually adjustable nozzles. The diffuser has an built-in damper and a measuring device for individual adjustment. DCS is equipped with a M8 threaded rod at the top for attaching the diffuser. The diffuser is suitable for the horizontal supply of cooled air, where great flexibility in the dispersal pattern is required.

- Individually adjustable nozzles
- Supplied with integrated M8 rivet nut for suspension
- Detachable damper for cleaning of duct.

Maintenance

The face plate can be detached and the damper removed to enable cleaning of the internal parts or the duct. The visible parts of the diffuser can be wiped with a damp cloth.

Order code

Product	DCS	aaa	A
Type			
DCS			
Duct connection Ød₁			
Ø100-315			
Version			
A			

Example: DCS-200-A

Dimensions

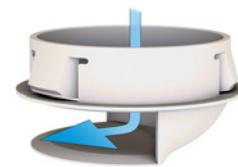
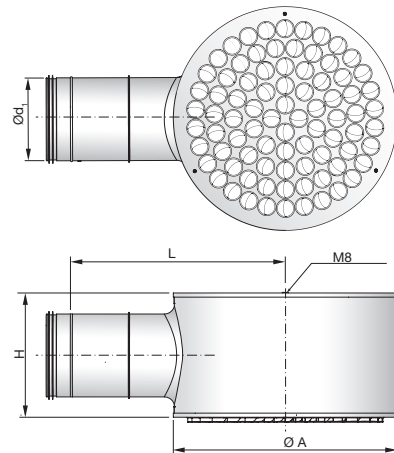

Ød ₁ Size mm	ØA mm	Ød ₁ mm	L mm	H mm	Weight kg
100	300	100	365	200	3.1
125	360	125	395	215	4.0
160	460	160	470	260	5.2
200	540	200	545	300	7.7
250	680	250	645	350	10.5
315	680	315	685	420	10.8

Materials and finish

Material:	Galvanised steel
Nozzles:	ABS Plastic, white
Standard finish:	Powder-coated
Standard colour:	White, RAL 9003 or 9010, gloss 30

The diffuser is available in other colours or unpainted. Please contact Lindab's sales department for further information.

Nozzle diffuser

DCS

Technical data

Capacity

Volume flow q_v [l/s] and [m³/h], total pressure Δp_t [Pa], throw $l_{0.2}$ [m] and sound power level L_{WA} [dB(A)] can be seen in the diagrams.

Frequency-related sound effect level

The sound effect level in the frequency band is defined as $L_{WA} + K_{ok}$. K_{ok} values are given in charts beneath the diagrams on the following pages.

Quick selection

Supply air

DCS Ød ₁ mm	Minimum P _t =5 Pa		p _t = 50 Pa L _{WA} =30 dB(A)		p _t = 50 Pa L _{WA} =35 dB(A)	
	l/s	m ³ /h	l/s	m ³ /h	l/s	m ³ /h
100	9	33	15	52	34	123
125	15	53	29	105	42	150
160	25	91	44	157	65	233
200	40	145	63	225	95	340
250	67	241	-	-	115	416
315	112	402	-	-	166	596

Throw $l_{0.2}$

The throw is specified at a terminal velocity of 0.2 m/s.

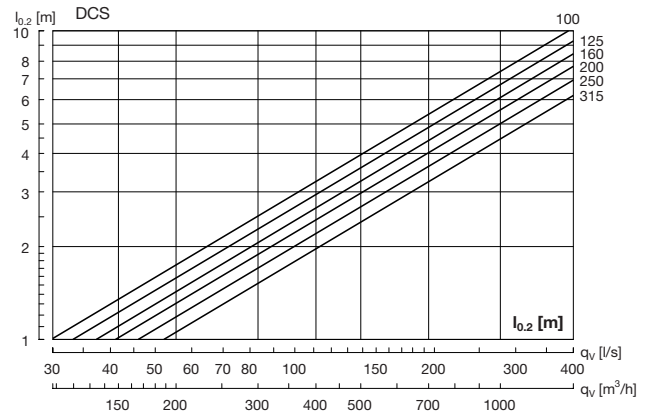

Sound attenuation

Sound attenuation of the diffusers ΔL from duct to room, including end reflection, see table below.

DCS Ød ₁ mm	Centre frequency Hz							
	63	125	250	500	1K	2K	4K	8K
100	14	9	6	17	14	11	9	16
125	16	11	5	14	12	9	10	16
160	14	10	5	16	10	9	9	14
200	11	7	7	13	8	7	9	14
250	11	7	9	9	7	7	10	14
315	9	6	11	9	6	8	10	14

Balancing

Balancing data is contained in a separate brochure.

Nozzle diffuser

DCS

Technical data

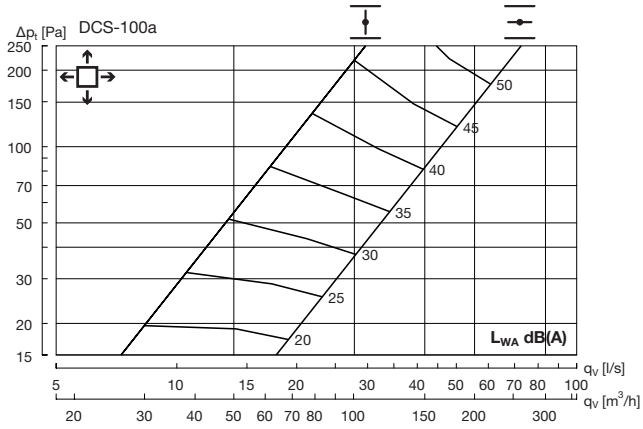

Hz	63	125	250	500	1K	2K	4K	8K
K_{sk}	7	4	5	-5	-7	-10	-14	-18

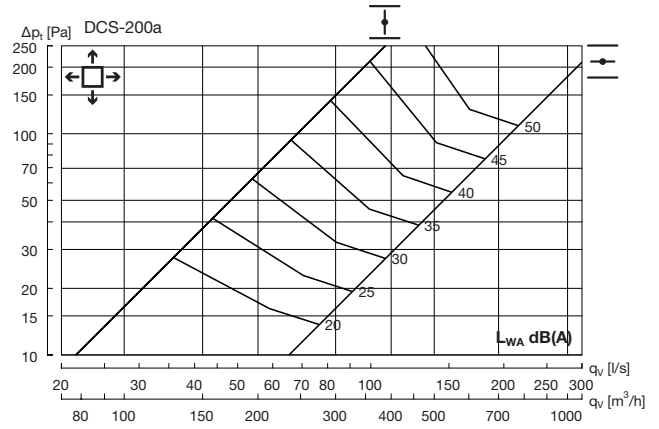

Hz	63	125	250	500	1K	2K	4K	8K
K_{sk}	11	8	1	-4	-6	-10	-15	-16

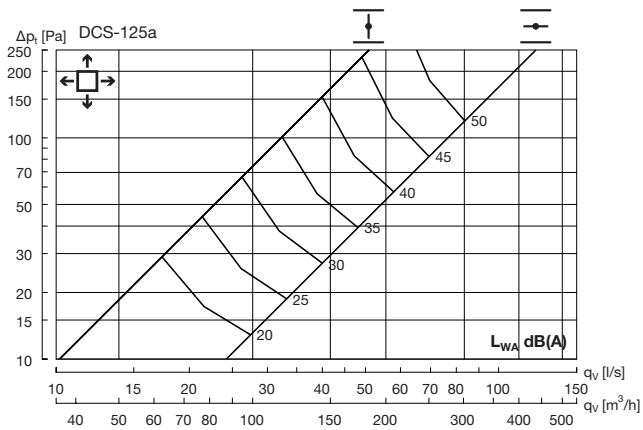

Hz	63	125	250	500	1K	2K	4K	8K
K_{sk}	7	4	4	-4	-7	-9	-14	-20

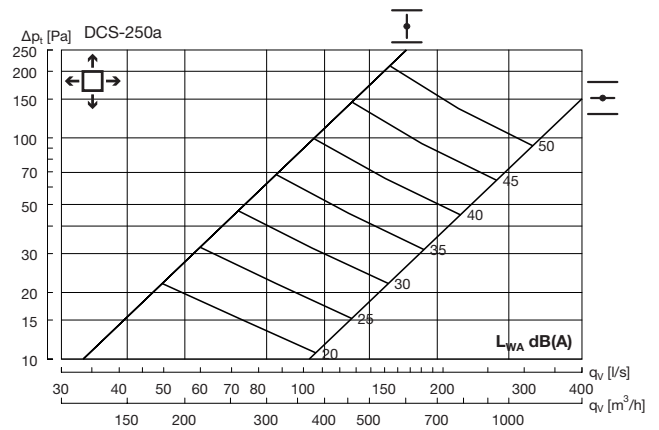

Hz	63	125	250	500	1K	2K	4K	8K
K_{sk}	11	8	1	-5	-6	-10	-14	-16

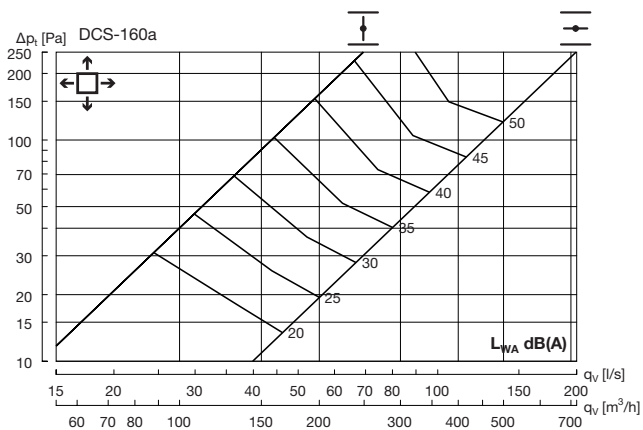

Hz	63	125	250	500	1K	2K	4K	8K
K_{sk}	11	8	3	-5	-6	-10	-17	-19

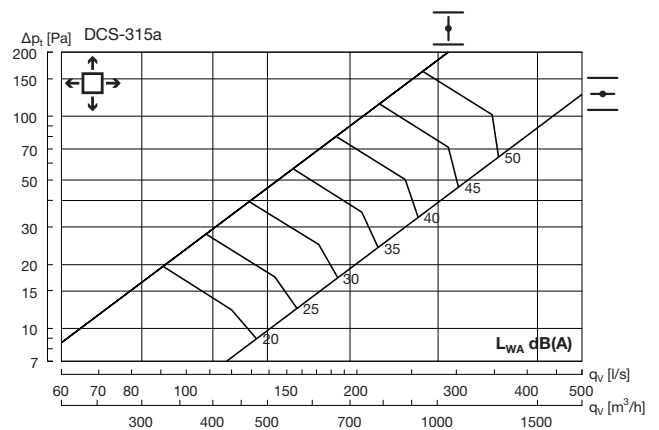

Hz	63	125	250	500	1K	2K	4K	8K
K_{sk}	9	6	1	-2	-6	-13	-16	-16