

# Lindab **UltraLink**<sup>®</sup> Heating and cooling control

Commissioning instruction

# UltraLink® Heating and cooling control

## Content

1.0 Function overview .....	3
1.1 Introduction .....	3
1.2 Feature description .....	3
1.3 Download application .....	3
1.4 Wireless sensors .....	4
1.5 Room regulation.....	4
1.6 Signal for controlling heating and cooling sources .....	4
1.7 Firmware update.....	4
2.0 Pairing instructions .....	5
2.1 Wireless temperature sensor to supply UltraLink.....	5
2.2 UltraLink to UltraLink as temperature sensor or slave unit .....	6
2.3 If sensor doesn't connect .....	8
3.0 Enable room regulation.....	8
3.1 Assign control variables for your system. ....	8
3.2 Temperature control.....	9
4.0 Set UltraLink to control heating and cooling sources via analog signal.....	9
4.1 Run cable between UltraLink and heating/cooling source.....	9
4.2 Make settings to analog output signal inside OneLink app .....	9
4.3 Disable increased airflow when heating/cooling .....	11

# UltraLink<sup>®</sup> Heating and cooling control

## 1.0 Function overview

### 1.1 Introduction

The heating and cooling feature is accessible from Lindab UltraLinks type  $\geq 4$ . You can read the type number on the UltraLink product label.

This commissioning instruction describes the functionality and commissioning steps of the heating- and/or cooling feature where you can control your heating and cooling sources from the registered values of an UltraLink.

The configuration is done in Lindab OneLink application via a smart device.

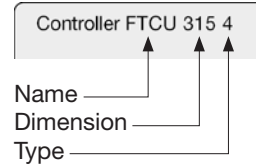

### 1.2 Feature description

By reading the temperature of the extract air or the room temperature via a wireless sensor, this feature will enable your UltraLink to control your heating and/or cooling sources via analog output signals. The signals on the analog ports AO1 and AO2 will be configured for heating and/or cooling from the OneLink app.

When heating and/or cooling feature is enabled on the analog ports, the control curve that control the temperature by air will convert the max scale factor to 100% and the minimum factor to 0%. This means that the proportional regulation on the analog ports will always vary between 0-100%. The percentage is converted to the corresponding voltage level based on what type of control signal we have specified when configuring the analog ports (0-10V, 2-10V, 10-0V or 10-2V).

The analog signals can be used for any passive heating and/or cooling source with an analogue actuator.

The UltraLink has a smart programming which prohibits both heating and cooling at the same time.

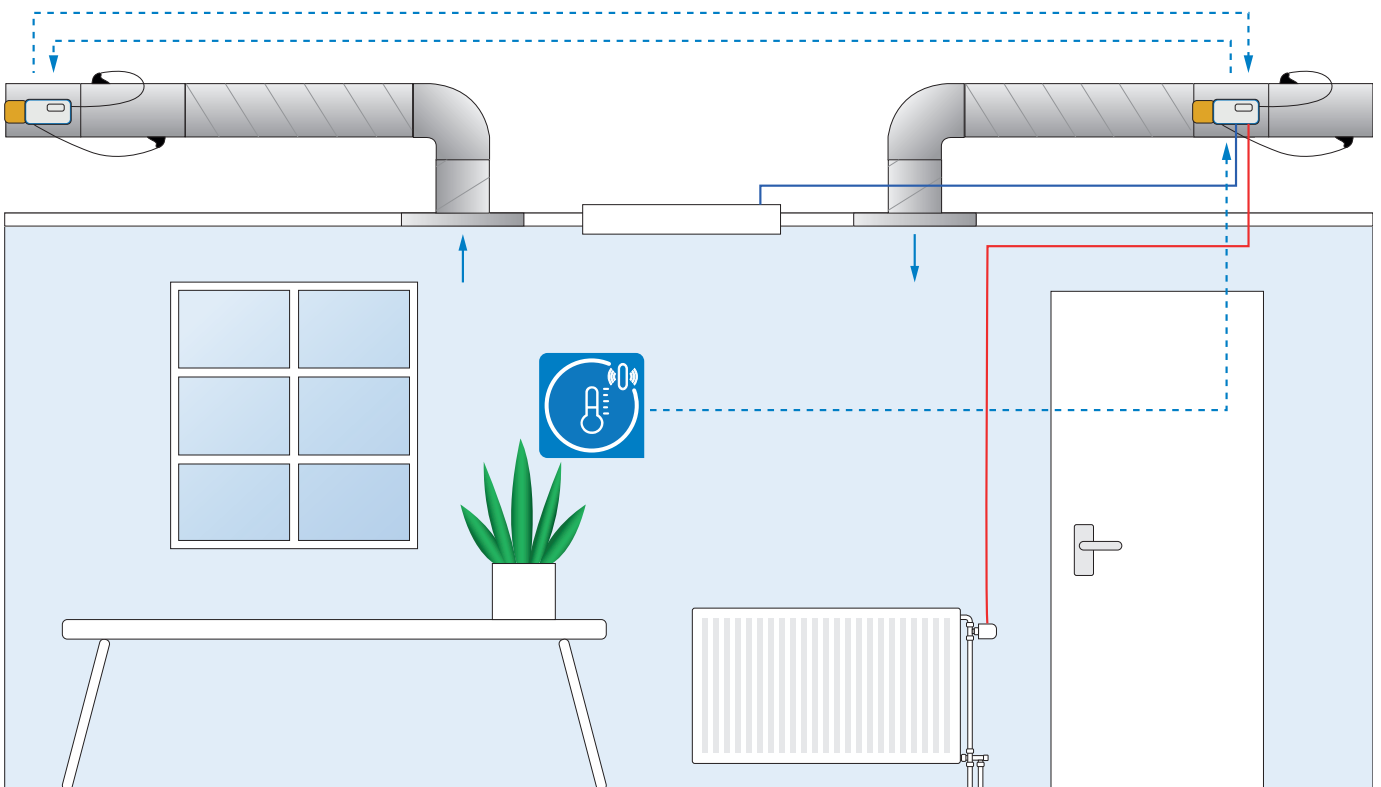

### 1.3 Download application

Commissioning application - Lindab OneLink™



# UltraLink<sup>®</sup> Heating and cooling control

## 1.4 Wireless sensors

Up to five wireless sensors can be connected to one UltraLink using a smart device and the Lindab OneLink app. After successful pairing of a sensor, its readings are available both in the app but also in the registers where they are accessed under the following modbus registers:

Register	Reading	
3x2021	Temperature	Min
3x2022		Max
3x2023		Average

If you connect more than one sensor that reports the same variable type (for example two temperature sensors) then you can choose to read either the max, min or average value according to the table above.

## 1.5 Room regulation

The regulation will not strive to always reach a given set point. It will maintain the climate within the allowed deviation that is configured.

It can only maintain a climate where the supply air has the possibility to support it. It means that it can not give a lower temperature than the temperature in the supply air, if not connected to any cooling source.

The room regulation works by applying a multiplication factor to the normal flow.

As long as the regulation is within its deadband the regulation factor is 1.0. As soon as it move outside the deadband a multiplication factor is applied to the normal flow - meaning that the flow will increase. Before the system applies to the factor a check is automatically made to make sure that an increase of the flow actually improves the conditions. It will for example not increase the flow if the indoor temperature is too low and the supply air temperature is even lower.

## 1.6 Signal for controlling heating and cooling sources

Control of heating and cooling sources can be added using analog signals from the UltraLink. The signals on the analog ports AO1 and AO2 can be configured for heating and/or cooling using the OneLink app. If heating and/or cooling is enabled on the analog ports, the same control curve that controls the temperature by air is used, but with one important difference. The max scale factor used to calculate the signal is always 100% and the minimum factor is 0%. This means that the proportional regulation on the analog ports will always vary between 0-100%. The percentage is converted to the corresponding voltage level based on what type of control signal we have specified when configuring the analog ports (0-10V, 2-10V, 10-0V or 10-2V). The analog signals can be used for any passive heating or cooling source with an analogue actuator, e.g. Lindab APR 40405.

## 1.7 Firmware update

By regularly searching for and carrying out firmware upgrades, you ensure optimal performance and the latest functionality of your UltraLink.

### How to upgrade your firmware

1. Open OneLink app and log in to UltraLink
2. Go to "Configuration" > "Device info"
3. Click on "Firmware update"

# UltraLink<sup>®</sup> Heating and cooling control

## 2.0 Pairing instructions

### 2.1 Wireless temperature sensor to supply UltraLink.

- 2.1.1 Turn on sensor according to specific sensor instruction.
- 2.1.2 Open OneLink application.
- 2.1.3 Scan for devices and connect to supply UltraLink.

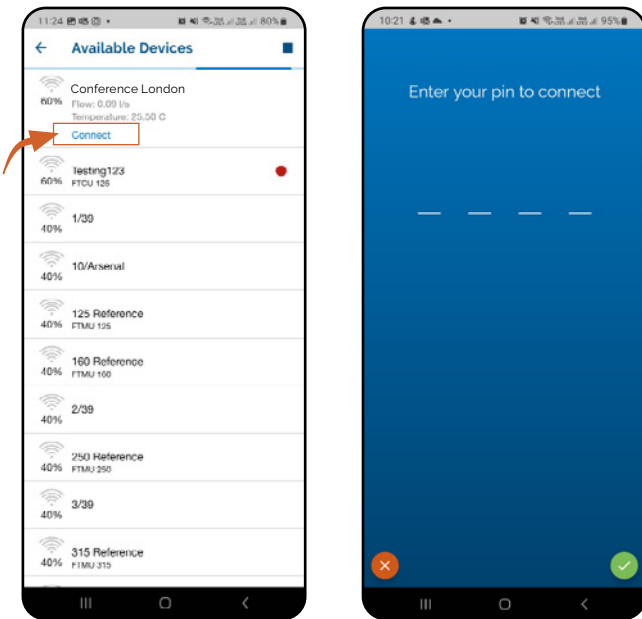

Default PIN: 1111

### 2.1.4 Go to "Configuration"



### 2.1.5 Go to "Wireless sensors".

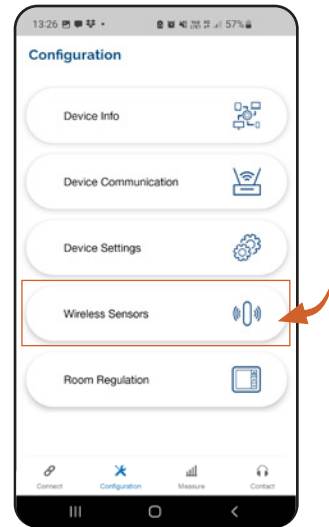

### 2.1.6 Tap on one of the available (grey colored) sensor slots.

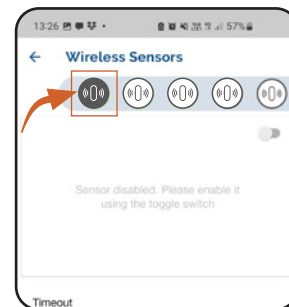

### 2.1.7 Click on "MAC address" and scan the QR-code attached to your sensor.

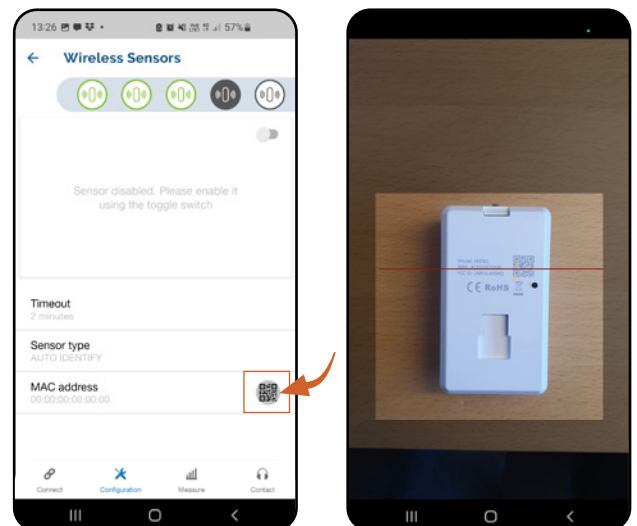

# UltraLink® Heating and cooling control

If the sensor is not available for pairing - please make sure you have the latest firmware update. See ["1.7 Firmware update" on page 4](#)

## 2.1.8 Click on enable sensor.

Wait for the sensor to connect. When the sensor icon turns green, it's connected. This might take a few seconds.

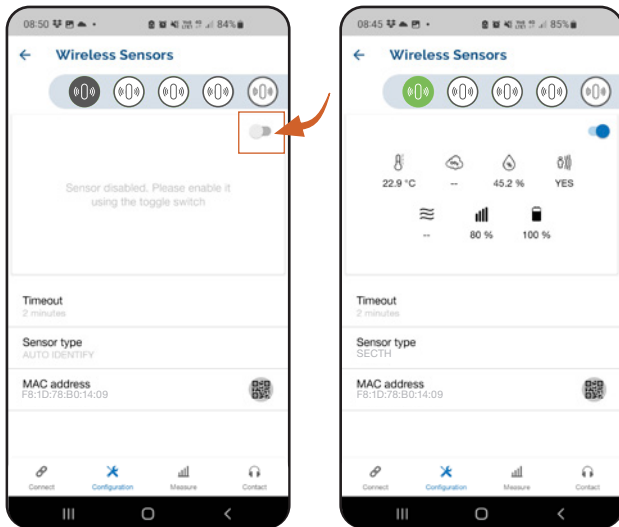

- OK
- Error → Go to ["2.3 If sensor doesn't connect"](#)
- Waiting
- Inactive

## 2.2 UltraLink to UltraLink as temperature sensor or slave unit

If you wish to use the extract UltraLink as temperature sensor to the supply UltraLink, you need to pair the extract UltraLink to the supply UltraLink.

To complete the commissioning of the heating and cooling control function we recommend to also pair the supply UltraLink to the extract UltraLink so that the extract UltraLink acts as slave unit to the supply UltraLink.

The steps in this paragraph describes the pairing steps.

### 2.2.1 Open OneLink application.

### 2.2.2 Scan for devices and connect to your UltraLink.

When pairing extract UltraLink to supply UltraLink as temperature sensor - connect to the extract UltraLink in this step.

If pairing extract UltraLink to extract UltraLink as slave - connect to the supply UltraLink in this step.

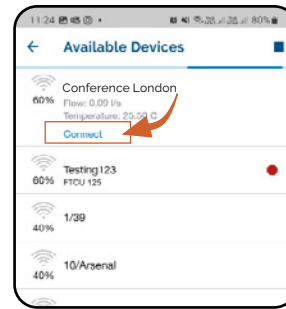

Default PIN: 1111

### 2.2.3 Copy the UltraLink MAC address.

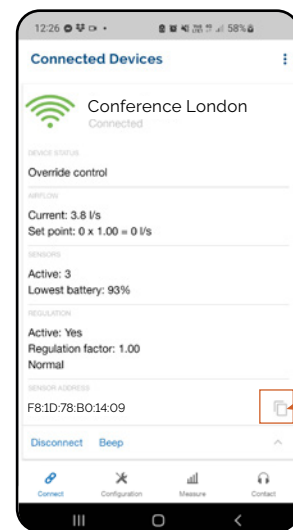

### 2.2.4 Disconnect UltraLink.

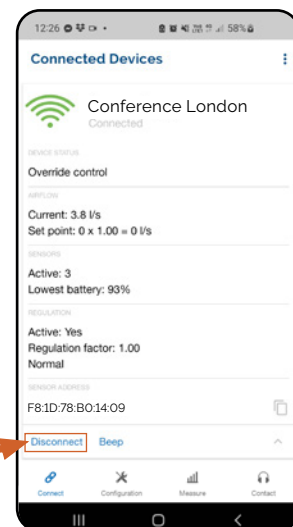

### 2.2.5 Scan for devices again and connect to the other UltraLink.

# UltraLink<sup>®</sup> Heating and cooling control

When pairing extract UltraLink to supply UltraLink as temperature sensor - connect to the supply UltraLink in this step.

If pairing extract UltraLink to extract Ultralink as slave - connect to the extract UltraLink in this step.

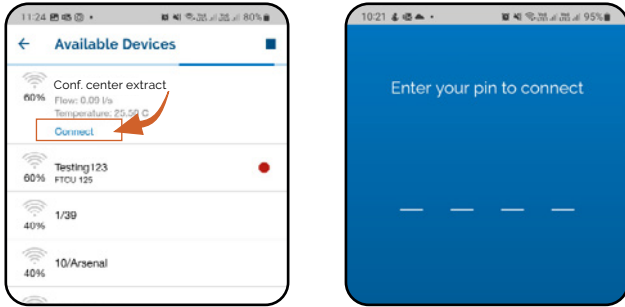

Default PIN: 1111

2.2.6 Go to "Configuration".



2.2.7 Go to "Wireless sensors".



2.2.8 Tap on one of the available (grey colored) sensor slots.

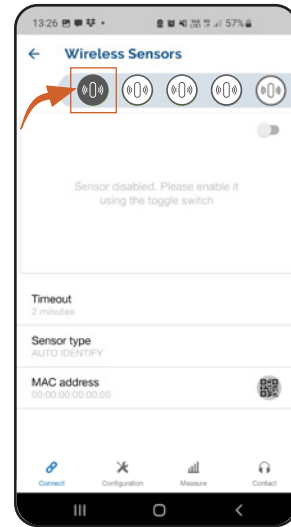

2.2.9 Click on "MAC address" and paste the copied UltraLink MAC-address.

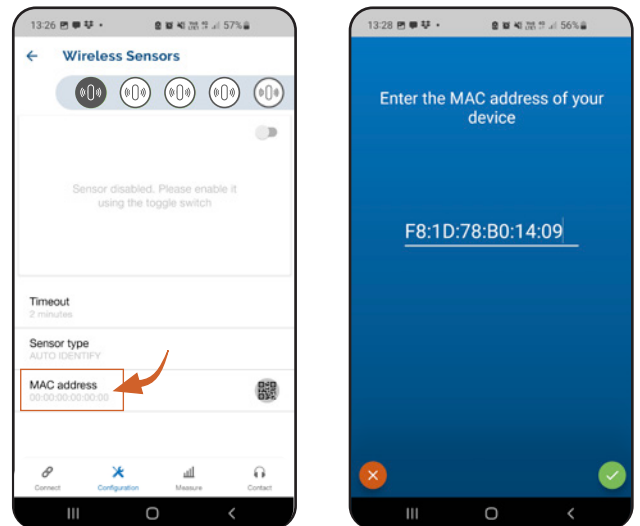

# UltraLink<sup>®</sup> Heating and cooling control

## 2.2.10 Click on enable sensor.

Wait for the sensor to connect. When the sensor icon turns green, it's connected. This might take a few seconds.

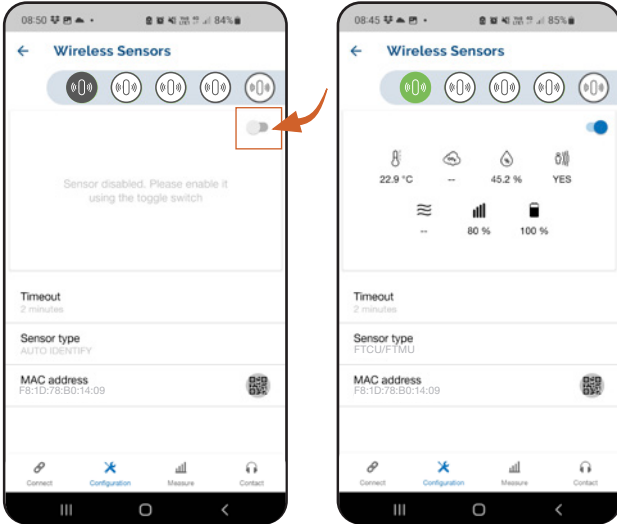

- OK
- Error → Go to ["2.3 If sensor doesn't connect" on page 8](#)
- Waiting
- Inactive

## 2.3 If sensor doesn't connect

3.3.1 Check the sensor battery.

3.3.2 Check that the distance between the sensor and the UltraLink doesn't exceed maximum bluetooth range.

You can find the maximum distance value and other requirements for your specific sensor in the sensor data sheet.

[Link to sensor documentation >>](#)

## 3.0 Enable room regulation

### 3.1 Assign control variables for your system.

3.1.1 Open OneLink application.

3.1.2 Scan for devices and connect to the supply UltraLink.

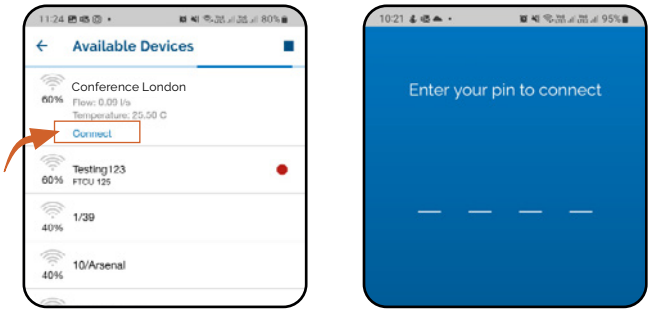

Standard PIN: 1111

3.1.3 Go to "Configuration".

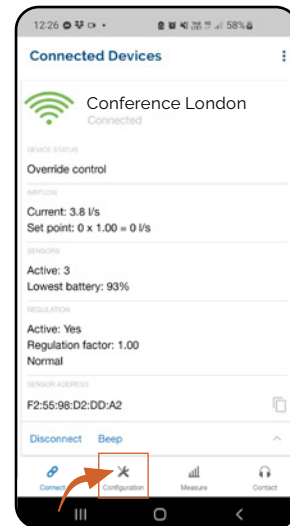

3.1.4 Go to "Room Regulation".





# UltraLink® Heating and cooling control

3.1.5 The top bar represents the different variables which you can use to control your room/zone.

### Regulation types:

-  Temperature
-  CO<sub>2</sub>
-  Relative humidity
-  Presence
-  Airflow

### Status light:

-  Working
-  Standby
-  Not available
-  Inactive

### 3.2 Temperature control



Detailed information

Reset values to default  
Toggle graph (% / l/s)

Graph

Off - no regulation on temperature  
Min - regulate according to minimum value  
Max - regulate according to max temperature value reported from configured temperature sensor  
Avg - regulate according to average value

Target temperature

Allowed deviation +/- from Baseline

How much the control value can deviate from Baseline before regulation starts

Maximum factor for multiplication with the normal airflow set point of the UltraLink when temperature value is outside of allowed deviation.

### 4.0 Set UltraLink to control heating and cooling sources via analog signal

#### 4.1 Wire cable between UltraLink and heating/cooling source

- 4.1.1 Cut the power supply to the supply UltraLink.
- 4.1.2 Install analog actuator onto the heating/cooling source.
- 4.1.3 Wire cable between actuator and UltraLink AO1 or AO2. *IMPORTANT:* If you are using both heating and cooling source to the same FTCU - make sure to use the common ground.

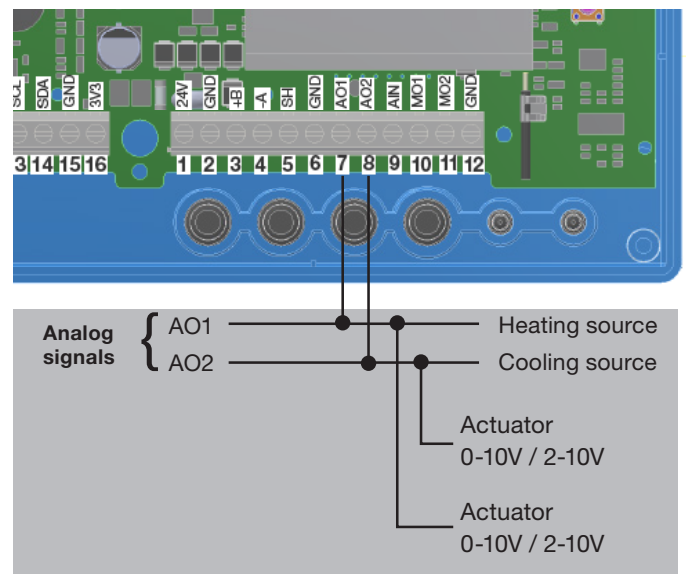

4.1.4 Restore the power supply to the supply UltraLink and turn it on.

#### 4.2 Make settings to analog output signal inside OneLink app

4.2.1 Inside OneLink app; Go to "Configuration".

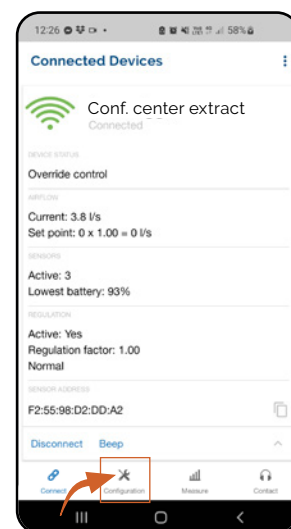

# UltraLink<sup>®</sup> Heating and cooling control

4.2.2 Go to "Device settings".



4.2.3 Go to "Setting of analog output AO1"/"AO2"

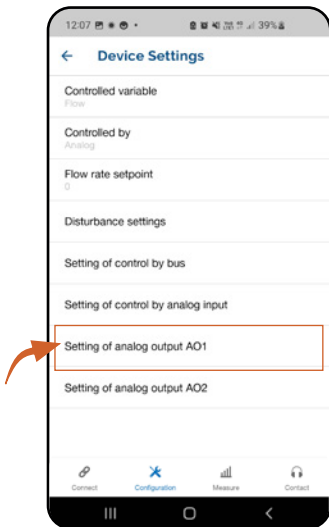

4.2.4 Click on "Variable" and select "cooling" or "heating"

If you are not able to select cooling or heating as analog output, you need to do a firmware update to your UltraLink. See ["1.7 Firmware update" on page 4](#).

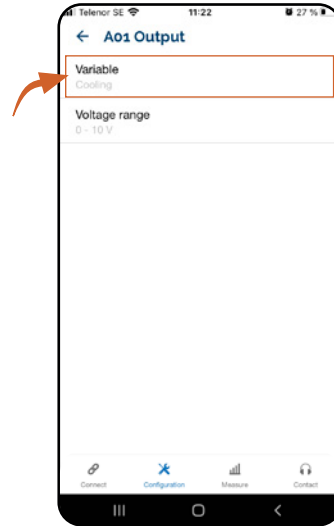

4.2.5 Click on "Voltage range" and select the voltage range according to the actuator.

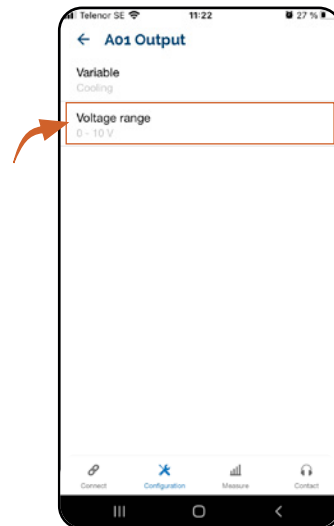

To enable additional heating and/or cooling steering the following steps are also mandatory:

- **Pairing temperatur sensor to supply UltraLink.**

You can choose to read the room temperature via wireless sensor placed in the room, or via the extract UltraLink.

# UltraLink<sup>®</sup> Heating and cooling control

To read temperature via wireless room sensor, see paragraph ["2.1 Wireless temperature sensor to supply UltraLink." on page 5.](#)

To read temperature via extract UltraLink, see paragraph: ["2.2 UltraLink to UltraLink as temperature sensor or slave unit" on page 6.](#)

- **Enable room regulation via temperature, see paragraph:** ["3.2 Temperature control" on page 9](#)

### 4.3 Disable increased airflow when heating/cooling

If your setup is based on disabling increased airflow when heating/cooling you need to set the "Max scale factor" for temperature control to 100%. By doing so, the temperature will be adjusted using only the heating/cooling source.



Most of us spend the majority of our time indoors. Indoor climate is crucial to how we feel, how productive we are and if we stay healthy.

We at Lindab have therefore made it our most important objective to contribute to an indoor climate that improves people's lives. We do this by developing energy-efficient ventilation solutions and durable building products. We also aim to contribute to a better climate for our planet by working in a way that is sustainable for both people and the environment.

[Lindab | For a better climate](#)