

FBC 1-4-7

Installation booklet

This is a 29 page installation booklet.

English

FIRE DAMPER

CIRCULAR SERIES FBC1 - 4 - 7 - 300 Pa

Cert. N° 1812-CPR-1630 - 1812-CPR-1632 - 1812-CPR-1634



1MUBFBC1-4-7EN-LIND rev 24-01



www.lindab.com - Fire dampers are manufactured by MP3 Srl www.mp3-italia.it

For further information please refer to the Technical Manual.

As the manufacturer is constantly improving its products, the aesthetic or dimensional features, the technical data, the equipment and accessories indicated could be subject to variations.



OVERVIEW

■ Fire resistance classification according to EN 13501-3-2009

VERTICAL RIGID WALL						min. thickness 100mm min. density 550Kg/m ³
----------------------------	--	--	--	--	--	---



PRESSURE 300Pa



AXIS
IRRELEVANT



FIRE DIRECTION
(i ↔ o)

TYPE OF INSTALLATION		TYPE OF HOLE	SEALING AND DESCRIPTION	FBC1 (60 min)	FBC4 (90 min)	FBC7 (120 min)	
IN	INSIDE THE WALL, DUCTED BOTH SIDES	SQUARE HOLE b: Ø + 50 h: Ø + 50	MORTAR OR PLASTER PUTTY	Ei 60 S	Ei 90 S	Ei 120 S	
			ROCK WOOL WITH MORTAR OR PLASTER OF COVERAGE	Ei 60 S	Ei 90 S	Ei 120 S	
IN	INSIDE THE WALL, DUCTED ONE SIDE	SQUARE HOLE b: Ø + 50 h: Ø + 50	ROCK WOOL WITH PLASTERBOARD OR PROMATECT 100	Ei 60 S	Ei 90 S	Ei 120 S	
			MORTAR OR PLASTER PUTTY	Ei 60 S	Ei 90 S	Ei 120 S	
IN	INSIDE THE WALL, TRANSFER	CIRCULAR HOLE Ø + 50	ROCK WOOL WITH MORTAR OR PLASTER OF COVERAGE	Ei 60 S	Ei 90 S	Ei 120 S	
			ROCK WOOL WITH PLASTERBOARD OR PROMATECT 100	Ei 60 S	Ei 90 S	Ei 120 S	
		SQUARE HOLE min. 600 X 600	FIRE BATT (WEICHSCHOTT)	Ei 60 S	Ei 90 S	Ei 120 S	
			WET METHOD SEALING				DRY SEALING

VERTICAL LIGHT WALL						min. thickness 100mm
----------------------------	--	--	--	--	--	----------------------



PRESSURE 300Pa



AXIS
IRRELEVANT



FIRE DIRECTION
(i ↔ o)

TYPE OF INSTALLATION		TYPE OF HOLE	SEALING AND DESCRIPTION	FBC1 (60 min)	FBC4 (90 min)	FBC7 (120 min)	
IN	INSIDE THE WALL, DUCTED BOTH SIDES	SQUARE HOLE b: Ø + 50 h: Ø + 50	MORTAR OR PLASTER PUTTY	Ei 60 S	Ei 90 S	Ei 120 S	
			ROCK WOOL WITH MORTAR OR PLASTER OF COVERAGE	Ei 60 S	Ei 90 S	Ei 120 S	
IN	INSIDE THE WALL, DUCTED ONE SIDE	SQUARE HOLE b: Ø + 50 h: Ø + 50	ROCK WOOL WITH PLASTERBOARD OR PROMATECT 100	Ei 60 S	Ei 90 S	Ei 120 S	
			MORTAR OR PLASTER PUTTY	Ei 60 S	Ei 90 S	Ei 120 S	
IN	INSIDE THE WALL, TRANSFER	CIRCULAR HOLE Ø + 50	ROCK WOOL WITH MORTAR OR PLASTER OF COVERAGE	Ei 60 S	Ei 90 S	Ei 120 S	
			ROCK WOOL WITH PLASTERBOARD OR PROMATECT 100	Ei 60 S	Ei 90 S	Ei 120 S	
		SQUARE HOLE min. 600 X 600	FIRE BATT (WEICHSCHOTT)	Ei 60 S	Ei 90 S	Ei 120 S	
			WET METHOD SEALING				DRY SEALING



PRESSURE 300Pa



AXIS
IRRELEVANT

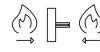

FIRE DIRECTION
(i ↔ o)

TYPE OF INSTALLATION		TYPE OF HOLE	SEALING AND DESCRIPTION	FBC1 (60 min)	FBC4 (90 min)	FBC7 (120 min)
IN	INSIDE THE WALL, DUCTED BOTH SIDES	SQUARE HOLE b: $\varnothing + 50$ h: $\varnothing + 50$	MORTAR OR PLASTER PUTTY	Ei 60 S	Ei 90 S	Ei 120 S
			ROCK WOOL WITH MORTAR OR PLASTER OF COVERAGE	Ei 60 S	Ei 90 S	Ei 120 S
			ROCK WOOL WITH PLASTERBOARD OR PROMATECT 100	Ei 60 S	Ei 90 S	Ei 120 S
IN	INSIDE THE WALL, DUCTED ONE SIDE	CIRCULAR HOLE $\varnothing + 50$	MORTAR OR PLASTER PUTTY	Ei 60 S	Ei 90 S	Ei 120 S
			ROCK WOOL WITH MORTAR OR PLASTER OF COVERAGE	Ei 60 S	Ei 90 S	Ei 120 S
IN	INSIDE THE WALL, TRANSFER	SQUARE HOLE min. 600 X 600	ROCK WOOL WITH PLASTERBOARD OR PROMATECT 100	Ei 60 S	Ei 90 S	Ei 120 S
			FIRE BATT (WEICHSCHOTT)	Ei 60 S	Ei 90 S	Ei 120 S
			WET METHOD SEALING		DRY SEALING	

VERTICAL SAFETY LIGHT WALL (BRANDWADE)



PRESSURE 300Pa



AXIS
IRRELEVANT

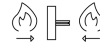







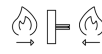

FIRE DIRECTION
(i ↔ o)

TYPE OF INSTALLATION		TYPE OF HOLE	SEALING AND DESCRIPTION	FBC1 (60 min)	FBC4 (90 min)	FBC7 (120 min)
IN	INSIDE THE WALL, DUCTED BOTH SIDES	SQUARE HOLE b: $\varnothing + 50$ h: $\varnothing + 50$	MORTAR OR PLASTER PUTTY	Ei 60 S	Ei 90 S	Ei 120 S
			ROCK WOOL WITH MORTAR OR PLASTER OF COVERAGE	Ei 60 S	Ei 90 S	Ei 120 S
			ROCK WOOL WITH PLASTERBOARD OR PROMATECT 100	Ei 60 S	Ei 90 S	Ei 120 S
IN	INSIDE THE WALL, DUCTED ONE SIDE	CIRCULAR HOLE $\varnothing + 50$	MORTAR OR PLASTER PUTTY	Ei 60 S	Ei 90 S	Ei 120 S
			ROCK WOOL WITH MORTAR OR PLASTER OF COVERAGE	Ei 60 S	Ei 90 S	Ei 120 S
IN	INSIDE THE WALL, TRANSFER	SQUARE HOLE min. 600 X 600	ROCK WOOL WITH PLASTERBOARD OR PROMATECT 100	Ei 60 S	Ei 90 S	Ei 120 S
			FIRE BATT (WEICHSCHOTT)	Ei 60 S	Ei 90 S	Ei 120 S
			WET METHOD SEALING		DRY SEALING	



PRESSURE 300Pa

AXIS
IRRELEVANTFIRE DIRECTION
(i ↔ o)

	TYPE OF INSTALLATION	TYPE OF HOLE	SEALING AND DESCRIPTION	FBC1 (60 min)	FBC4 (90 min)	FBC7 (120 min)
IN	 INSIDE THE WALL, DUCTED BOTH SIDES	SQUARE HOLE b: $\varnothing + 50$ h: $\varnothing + 50$	 MORTAR OR PLASTER PUTTY	Ei 60 S	Ei 90 S	Ei 120 S
IN	 INSIDE THE WALL, DUCTED ONE SIDE	CIRCULAR HOLE $\varnothing + 50$	 MORTAR OR PLASTER PUTTY	Ei 60 S	Ei 90 S	Ei 120 S
IN	 INSIDE THE WALL, TRANSFER	SQUARE HOLE min. 600 X 600	 FIRE BATT (WEICHSCHOTT)	Ei 60 S	Ei 90 S	Ei 120 S
					WET METHOD SEALING	

Cert. N° FBC1 1812-CPR-1630, FBC4 1812-CPR-1632, FBC7
1812-CPR-1634

■ Mechanism type

□ Manual

Blade closing mode

Automatic closing with thermal fuse.

The control mechanism has a thermosensitive element that automatically closes the blade when the temperature in the duct exceeds 70°C.

The damper can be closed manually as per the following instructions.

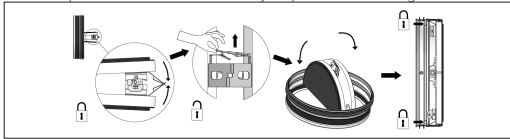

The fire damper is equipped with a spring for closing the blade: pay attention to the hands.

Blade opening mode

Make sure that the damper is open before the ventilation system start-up, otherwise there is a risk of product malfunction.

In case of closed damper as a result of the action of the thermosensitive element, it is possible to manually reopen the damper once the thermosensitive element has been replaced.

The fire damper can be opened manually as per the following instructions.

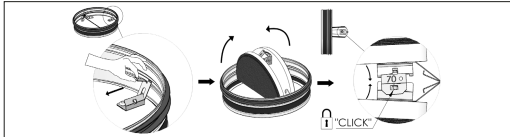

The fire damper is equipped with a spring for closing the blade: pay attention to the hands.

Position indication microswitch

On request, the fire damper can be supplied with position microswitch (separate accessory) that signal the closed position of the blade. Refer to the section Electrical connections for more details.

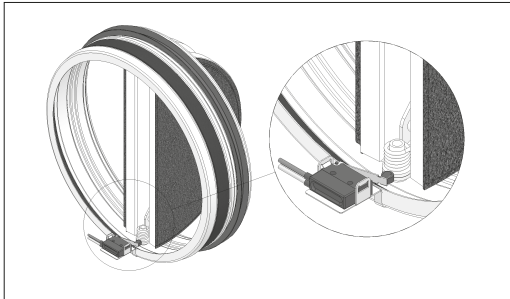

Temperature calibration of thermosensitive element for automatic damper closing

70 °C±7 °C

□ Closing by remote control

Not available

□ Motorized version

Not available

ELECTRICAL CONNECTIONS

■ Electrical wiring

Electrical connections must be done by qualified and trained people. Switch off the power supply before starting any work on the electric elements. Never switch on the power supply during electrical connections.

□ Wiring diagram for position microswitches

FCU: Closed damper contact

- A The fire damper's blade is open (the air flow is allowed)
- B The fire damper's blade is closed (the air flow is not allowed)
- 4 Normally opened (BLUE)
- 1 Common/neutral (BLACK)
- 2 Normally closed (GREY)

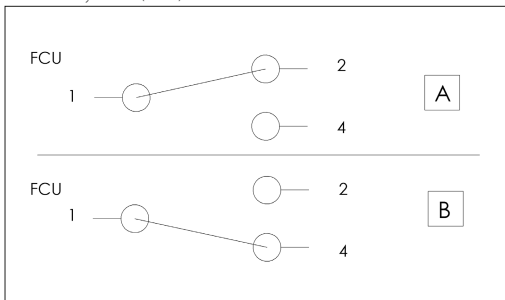

min. supply: 4V AC - 1 mA
max. supply: 250 V AC - 10 A

TECHNICAL DATA

The sizes shown are in mm.

■ Dimension

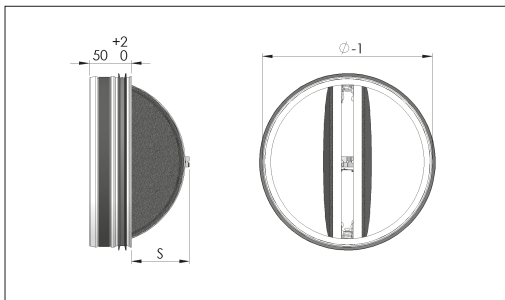

Ø	mm	100	125	160	200
S blade exposition	mm	21	34	51	72

MAINTENANCE AND INSPECTIONS

Fire dampers and control mechanisms do not require routine maintenance.

Extraordinary maintenance (repairs) and periodic inspection operations are the responsibility of the ventilation system operator. It is recommended to provide inspection hatches on both sides of the ducts connected to the fire damper.

The implementation of a periodic inspection plan allows to guarantee the efficiency and functionality of the fire dampers for the fire safety of the building.

■ Periodic inspection and cleaning

Periodic inspection shall be performed in accordance with the requirements of the law or by the building regulations or other local regulations.

In the absence of specific regulations (or to their complement), in accordance with point 8.3 of the EN 1560 standard, it is recommended

to carry out the following control activities at intervals of no more than 12 months:

- Check the servomotor electrical wiring for damage (where applicable);
- Check end-switch wiring for damage (where applicable);
- Check damper cleanliness and clean where necessary;
- Check the condition of blades and seals, rectify and report where necessary;
- Check the correct opening and closing of the fire damper by manual operation according to the instructions in the technical manual of the fire damper;
- Check the opening and closing operation of the damper controlled by the fire alarm system (if present);
- Check the operation of the end switches in open and closed state, adjust and report if necessary (if it is present);
- Confirm that the damper fulfils its function as part of the control system (where necessary);
- Check that the damper is left in its normal operating position, which usually corresponds to the open position.

■ Repair

For safety reasons, repair activities involving fire-fighting components must be carried out only by qualified personnel.

Only original spare parts supplied by the fire damper manufacturer must be used.

A functional test must be performed after each repair.

At the end of the inspection, cleaning or repair operations, check that the fire damper is in the normal operating position.

Keep records of all inspections, repair activities, any problems encountered and their resolution.

This practice, even when not mandatory, is very useful in practice.

■ Disposal

Disposal in case of destruction must be carried out in accordance with national legislation. For electrical and electronic parts also refer to EU Directive 2011/65.

INSTALLATION

The sizes shown are in mm.

It is recommended to perform a functional test before installation to exclude possible damage during transport.

The fire dampers FBC must be accessible for maintenance and inspections.

■ Blade rotation axis positioning

The fire damper can be installed with the blade axis positioned vertically or horizontally or tilted at any angle.

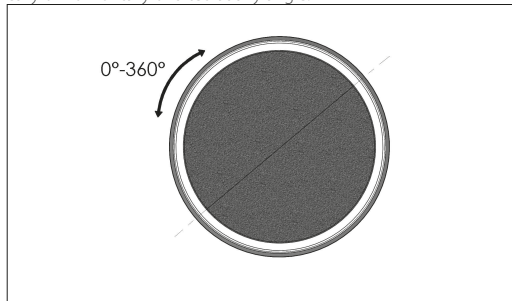

■ Installation of flexible connectors in order to balance out the ventilation ducts expansion

ATTENTION: the following regulations must be considered binding only if legislation or local regulation where the fire dampers are installed require the use of flexible connectors.

Flexible connectors compensate any duct thermal expansion and wall bending in case of fire.

Flexible connectors are used to limit fire damper stresses due to external forces in case of fire and to preserve fire resistance class.

In general it is always appropriate the use of flexible connectors for the followings installations:

- light walls;
- Plasterboard and rock wool or Fire Batt (Weichschott) sealing;
- Appliance fixing system.

Flexible connector must be normal flammability and in case of fire the grounding bonding should disconnect to guarantee the complete separation between fire damper and connected air duct.

When flexible connectors made of conductive material (e.g. aluminum) are used, no additional grounding bonding is required.

Despite flexible connector installation, the fire damper must be installed in the construction support so that its weight does not affect damper's installation position both during normal operation and in case of fire.

It is recommended not to compress flexible connectors in the installation phase.

Flexible connector must be at least 100mm long and in order that possible duct thermal expansions are balanced.

Take care that the flexible connector does not interfere with opening / closing movement of the blade.

Refer to the section Technical data for blade exposition values.

■ Minimum distances

In accordance with Articles 7 and 13 of EN 1366-2 respect the minimum distances indicated below.

Minimum distances

1. Vertical lateral wall
2. Floor

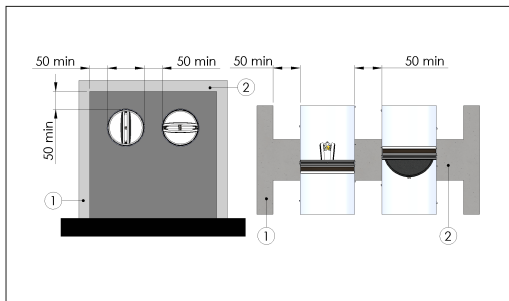

■ Construction supports characteristics

The European standard for fire dampers foresees a precise correlation between the wall/floor characteristics and the fire resistance class obtained, as well as the correlation between wall/floor used for the test and wall/floor used for the actual installation.

The test results obtained on a type of wall/floor are valid also for walls/floor of the same type but with greater thickness and/or density than those used in the test.

For plasterboard walls, the test results are also valid for walls with a greater number of plasterboard layers on each side.

As a result, the indicated thickness and density characteristics to be considered as minimum values.

The wall/floor in which the fire dampers are installed must be fire class certified according to the standards foreseen for the structure.

■ Rigid walls

Can be made with aerated concrete blocks, poured concrete, concrete panels, perforated cell elements in concrete or brick in accordance with the following characteristics:

- minimum thickness 100 mm;
- minimum density 550 kg/m³.

For walls built with perforated elements, it is also recommended that the area of the opening be made from full elements (for example aerated concrete blocks) to guarantee the correct adhesion of the mortar.

■ Light plasterboard vertical walls

During testing, light plasterboard walls have been used with the following characteristics:

- U-shaped horizontal metal frame (50 mm) and C-shaped vertical frame (49 mm) made from 0,6 mm thick sheet metal;
- vertical profiles placed with a maximum spacing of 1000 mm;
- Filling made of rock wool;

- Each side is made from two plasterboard layers 12,5 mm thick, unalined to avoid alignment between the joints of the layer above and below.

The following indications are given for the installation walls:

- metal profiles minimum width: 49 mm;
- metal profiles minimum thickness: 0,6 mm;
- vertical profiles placed with a maximum spacing of 1000 mm between each other;
- vertical profile fixing with selfthreading screws or by clinching to the bottom horizontal profile and insertion in the top horizontal profile;
- profiles fixed using self-threading screws or by clinching on every intersection.
- installation of a frame around the damper with base and height where shown in the installation instructions;
- Filling made of rock wool;
- each side is made from two plasterboard layers 12,5 mm minimum thick, unalined to avoid alignment between the joints of the layer above and below.
- the front plasterboards layers are fixed using long enough screws to pass through the lower plasterboard and attach to the steel profile underneath.

▣ Vertical plaster block wall (carreaux de plâtre)

Gypsum blocks wall can be built with special solid gypsum blocks with interlocking shaped edges as indicated in the supplier's instructions and according to the following characteristics:

- minimum thickness 70 or 100 mm according to the type and resistance class required;
- minimum density 995 kg/m³.

It is generally advisable to first build the wall and then provide the opening for the fire damper.

▣ Light plasterboard vertical walls with steel reinforcement (special / firewall)

During testing, light plasterboard walls have been used with the following characteristics:

- U-shaped horizontal metal frame (50 mm) and C-shaped vertical frame (49 mm) made from 0,6 mm thick sheet metal;
- Vertical profiles placed with a maximum spacing of 312,5 mm between each other;
- reinforcement sheet;
- Filling made of rock wool with density up to 40 kg/m³ (optional);
- Each side is made from two plasterboard layers 12,5 mm thick, unalined to avoid alignment between the joints of the layer above and below.

The following indications are given for the installation walls:

- metal profiles minimum width: 49 mm;
- metal profiles minimum thickness: 0,6 mm;
- vertical profiles placed with a maximum spacing of 312,5mm between each other;
- vertical profile fixing with selfthreading screws or by clinching to the bottom horizontal profile and insertion in the top horizontal profile;
- profiles fixed using self-threading screws or by clinching on every intersection.
- installation of a frame around the damper with base and height where shown in the installation instructions;
- Filling made of rock wool with density up to 100 kg/m³ (optional);
- each side is made from two plasterboard layers 12,5 mm minimum thick, unalined to avoid alignment between the joints of the layer above and below.
- the front plasterboards layers are fixed using long enough screws to pass through the lower plasterboard and attach to the steel profile underneath.

▣ Concrete floors

Concrete floors can be built during installation or with preformed slabs with interlocking shaped edges or hollow bricks and concrete according to the following characteristics:

- minimum thickness 100 or 150 mm according to the type and resistance class required;
- minimum density 550 kg/m³.

■ Installations within vertical rigid wall

Refer to the section Construction supports characteristics for further information.

Comply with the minimum distances indicated on section Minimum distances.

Before and after installation please perform a functional test. Refer to section Mechanism type for further information.

■ Wall opening

An opening must be provided in the wall as indicated in the drawing.

■ Damper positioning

Install the fire damper in the ventilation duct as shown in the drawing.

Close the blade before installing the fire damper.

■ Filling

Fill the space between ventilation duct and wall as indicated in the drawing.

■ Insulation

The walls must be of the same or higher strength class than the damper.

Rigid wall, ducted on both sides, square hole, mortar or plaster putty

1. Mortar or plaster grouting
 2. Fire damper
 3. Ventilation duct
 4. Vertical rigid wall
- D from nominal diameter min + 50 to nominal diameter max + 70

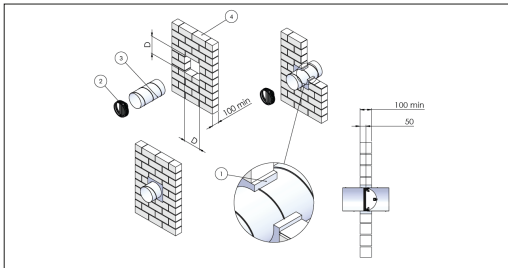

Rigid wall, ducted on one side, square hole, mortar or plaster putty

1. Mortar or plaster grouting
 2. Terminal valve
 3. Fire damper
 4. Ventilation duct
 5. Vertical rigid wall
- D from nominal diameter min + 50 to nominal diameter max + 70

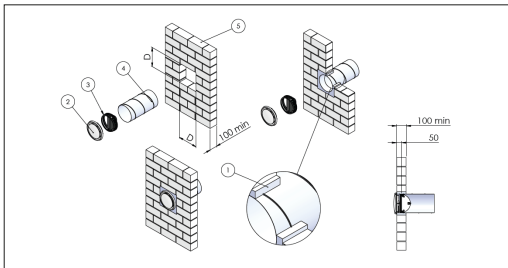

Rigid wall, transfer, square hole, mortar or plaster putty

1. Mortar or plaster grouting
 2. Terminal valve
 3. Fire damper
 4. Ventilation duct
 5. Vertical rigid wall
- D from nominal diameter min + 50 to nominal diameter max + 70

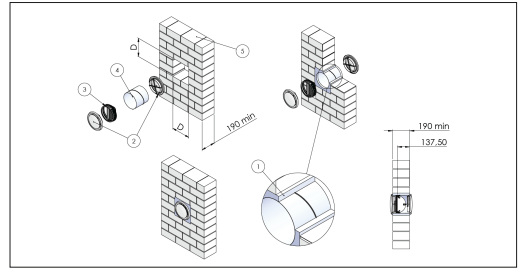

Rigid wall, ducted on both sides, square hole, rock wool with mortar or plaster putty

1. Rock wool, 40 kg/m³
 2. Mortar or plaster grouting
 3. Fire damper
 4. Ventilation duct
 5. Vertical rigid wall
- D from nominal diameter min + 50 to nominal diameter max + 70

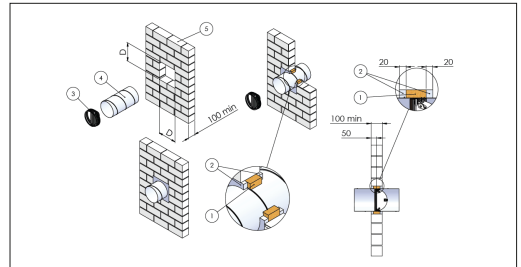

Rigid wall, ducted on one side, square hole, rock wool with mortar or plaster putty

1. Rock wool, 40 kg/m³
 2. Mortar or plaster grouting
 3. Terminal valve
 4. Fire damper
 5. Ventilation duct
 6. Vertical rigid wall
- D from nominal diameter min + 50 to nominal diameter max + 70

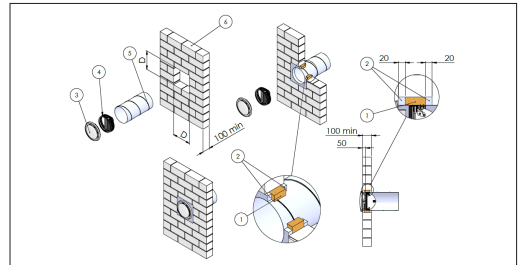

Rigid wall, transfer, square hole, rock wool with mortar or plaster putty

1. Mortar or plaster grouting
 2. Rock wool, 40 kg/m³
 3. Terminal valve
 4. Fire damper
 5. Ventilation duct
 6. Vertical rigid wall
- D from nominal diameter min + 50 to nominal diameter max + 70

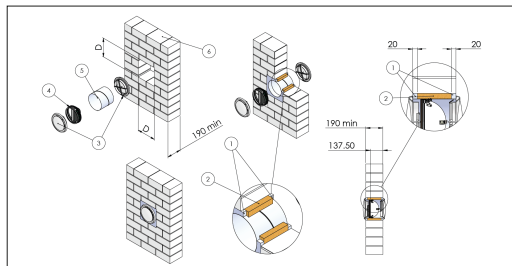

Rigid wall, ducted both sides, square hole, rock wool plasterboard - EI60-S - FBC1

1. Rock wool, 40 kg/m³
 2. Fire damper
 3. Ventilation duct
 4. Rigid vertical wall
 5. Plasterboard arch infill, thickness 12,5 mm or promatect 100 thickness 12 mm
 6. Self-drilling screw \varnothing 3,5 X 45 mm
- D from nominal diameter min + 50 to nominal diameter max + 70

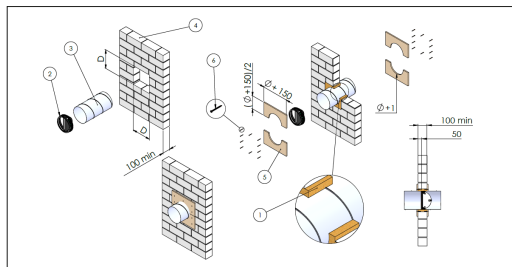

Rigid wall, ducted both sides, square hole, rock wool plasterboard - EI90-S - FBC4- EI120-S - FBC7

1. Rock wool 40 kg/m³
 2. Fire damper
 3. Ventilation duct
 4. Rigid vertical wall
 5. Plasterboards arch infill type F, thickness 12,5 mm or promatect 100 thickness 12 mm
 6. Self-drilling screw \varnothing 3,5 X 45 mm
- D from nominal diameter min + 50 to nominal diameter max + 70

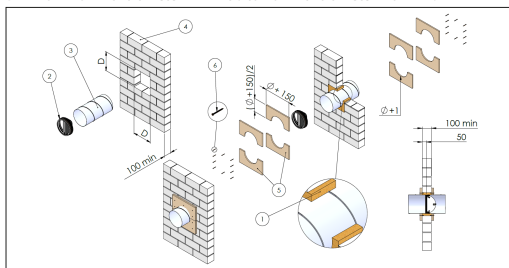

Rigid wall, ducted one side, square hole, rock wool with plasterboard

1. Rock wool, 40 kg/m³
 2. Terminal valve
 3. Fire damper
 4. Ventilation duct
 5. Rigid vertical wall
 6. Plasterboard arch infill, thickness 12,5 mm or promatect 100 thickness 12 mm
 7. Self-drilling screw \varnothing 3,5 X 45 mm
- D from nominal diameter min + 50 to nominal diameter max + 70

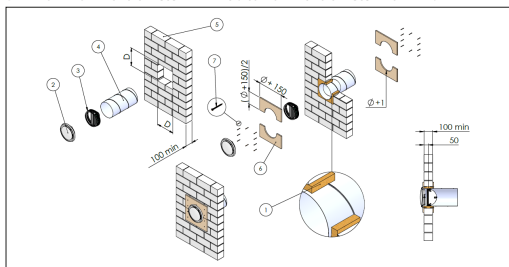

Rigid wall, transfer, square hole, rock wool plasterboard

1. Rock wool, 40 kg/m³
 2. Terminal valve
 3. Fire damper
 4. Ventilation duct
 5. Rigid vertical wall
 6. Plasterboard arch infill, thickness 12,5 mm or promatect 100 thickness 12 mm
 7. Self-drilling screw \varnothing 3,5 X 45 mm
- D from nominal diameter min + 50 to nominal diameter max + 70

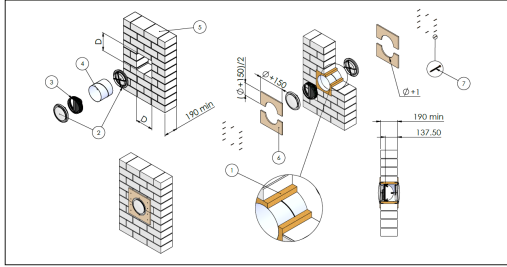

Rigid wall, channelled both sides, circular hole, mortar or plaster putty

1. Mortar or plaster grouting
 2. Fire damper
 3. Ventilation duct
 4. Vertical rigid wall
- D from nominal diameter min + 50 to nominal diameter max + 70

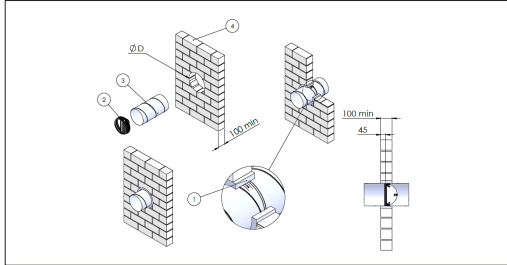

Rigid wall, channelled one side, circular hole, mortar or plaster putty

1. Mortar or plaster grouting
 2. Terminal valve
 3. Fire damper
 4. Ventilation duct
 5. Vertical rigid wall
- D from nominal diameter min + 50 to nominal diameter max + 70

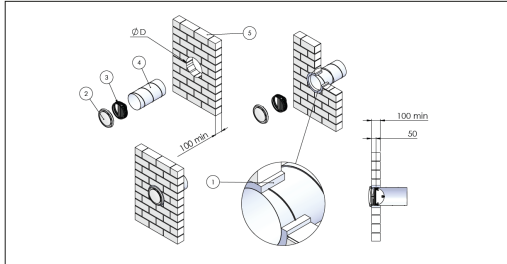

Rigid wall, transfer, circular hole, mortar or plaster putty

1. Mortar or plaster grouting
 2. Terminal valve
 3. Fire damper
 4. Ventilation duct
 5. Vertical rigid wall
- D from nominal diameter min + 50 to nominal diameter max + 70

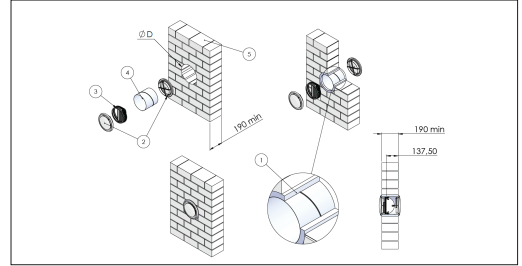

Rigid wall, channelled both sides, circular hole, rock wool with mortar or plaster filler

1. Rock wool, 40 kg/m³
 2. Mortar or plaster grouting
 3. Fire damper
 4. Ventilation duct
 5. Vertical rigid wall
- D from nominal diameter min + 50 to nominal diameter max + 70

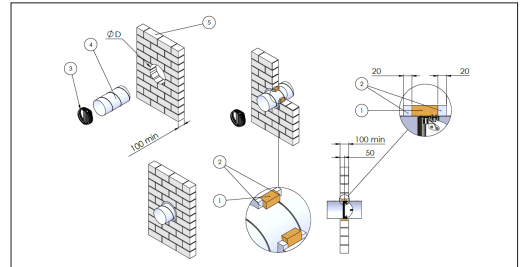

Rigid wall, ducted one side, circular hole, rock wool with mortar or plaster putty

1. Rock wool, 40 kg/m³
 2. Mortar or plaster grouting
 3. Terminal valve
 4. Fire damper
 5. Ventilation duct
 6. Vertical rigid wall
- D from nominal diameter min + 50 to nominal diameter max + 70

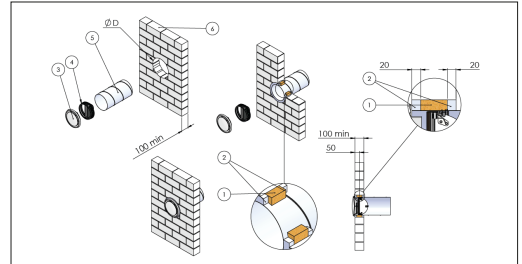

Rigid wall, transfer, round hole, rock wool with mortar or plaster putty

1. Mortar or plaster grouting
 2. Rock wool, 40 kg/m³
 3. Terminal valve
 4. Fire damper
 5. Ventilation duct
 6. Vertical rigid wall
- D from nominal diameter min + 50 to nominal diameter max + 70

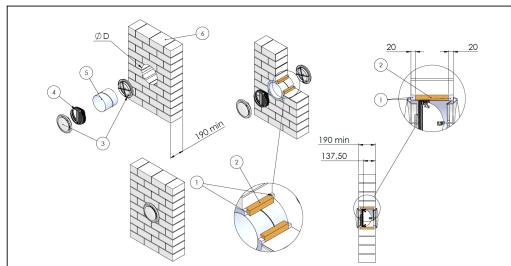

Rigid wall, ducted both sides, circular hole, rock wool with plasterboard - EI60-S - FBC1

1. Rock wool, 40 kg/m³
 2. Fire damper
 3. Ventilation duct
 4. Rigid vertical wall
 5. Plasterboard arch infill, thickness 12,5 mm or promatect 100 thickness 12 mm
 6. Self-drilling screw \varnothing 3,5 X 45 mm
- D from nominal diameter min + 50 to nominal diameter max + 70

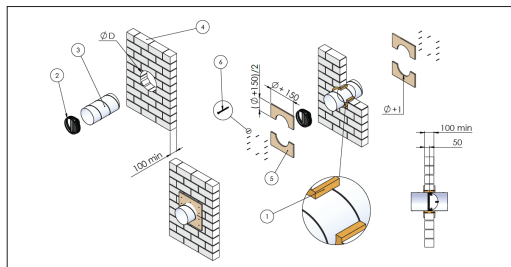

Rigid wall, ducted both sides, circular hole, rock wool with plasterboard - EI90-S - FBC4- EI120-S - FBC7

1. Rock wool, 40 kg/m³
 2. Fire damper
 3. Ventilation duct
 4. Rigid vertical wall
 5. Plasterboards arch infill type F, thickness 12,5 mm or promatect 100 thickness 12 mm
 6. Self-drilling screw \varnothing 3,5 X 45 mm
- D from nominal diameter min + 50 to nominal diameter max + 70

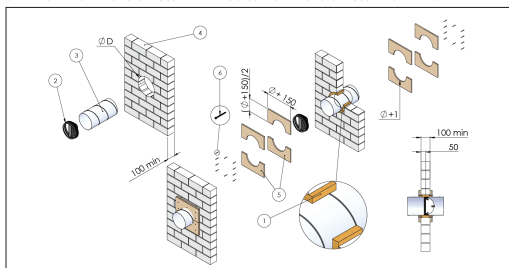

Rigid wall, ducted one side, circular hole, rock wool with plasterboard

1. Rock wool, 40 kg/m³
 2. Terminal valve
 3. Fire damper
 4. Ventilation duct
 5. Rigid vertical wall
 6. Plasterboard arch infill, thickness 12,5 mm or promatect 100 thickness 12 mm
 7. Self-drilling screw \varnothing 3,5 X 45 mm
- D from nominal diameter min + 50 to nominal diameter max + 70

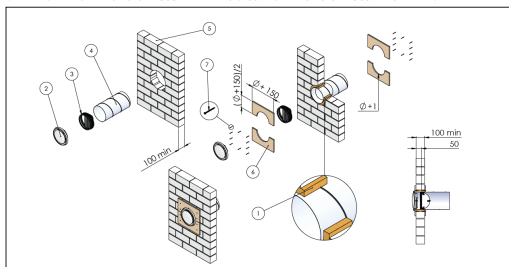

Rigid wall, transfer, round hole, rock wool with plasterboard

1. Rock wool, 40 kg/m³
 2. Terminal valve
 3. Fire damper
 4. Ventilation duct
 5. Rigid vertical wall
 6. Plasterboard arch infill, thickness 12,5 mm or promatect 100 thickness 12 mm
 7. Self-drilling screw \varnothing 3,5 X 45 mm
- D from nominal diameter min + 50 to nominal diameter max + 70

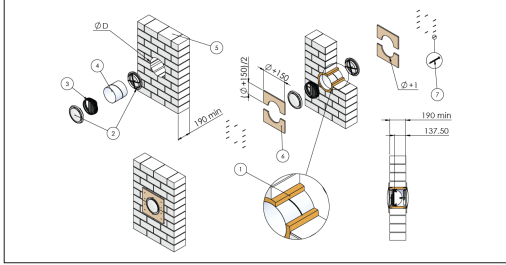

■ Installations within vertical light wall (plasterboard)

Refer to the section Construction supports characteristics for further information.

Comply with the minimum distances indicated on section Minimum distances.

Before and after installation please perform a functional test. Refer to section Mechanism type for further information.

■ Wall opening

A opening must be provided in the wall as indicated in the drawing.

■ Damper positioning

Install the fire damper in the ventilation duct as shown in the drawing.

Close the blade before installing the fire damper.

■ Filling

Fill the space between ventilation duct and wall as indicated in the drawing.

■ Insulation

Only in the case of a light vertical wall with two dampers closer than 200 mm and rock wool sealing, bands BELT-FBC- \varnothing are required on both sides of the wall or shaft, only on the accessible side. With other sealings they are not necessary.

Light wall, ducted on both sides, square hole, mortar or plaster putty

1. Rock wool density up to 40 kg/m³ (optional)
 2. Metal frame
 3. plasterboard, thickness 12,5 mm type A: FBC1; type F: FBC4 and FBC7 (EN 520)
 4. Mortar or plaster putty
 5. Fire damper
 6. Ventilation duct
- D from nominal diameter min + 50 to nominal diameter max + 70

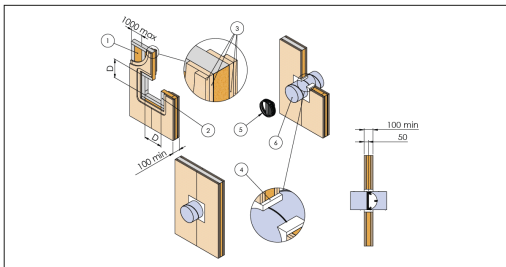

Light wall, ducted on one side, square hole, mortar or plaster putty

1. Rock wool density up to 40 kg/m³ (optional)
 2. Metal frame
 3. plasterboard, thickness 12,5 mm type A: FBC1; type F: FBC4 and FBC7 (EN 520)
 4. Mortar or plaster putty
 5. Terminal valve
 6. Fire damper
 7. Ventilation duct
- D from nominal diameter min + 50 to nominal diameter max + 70

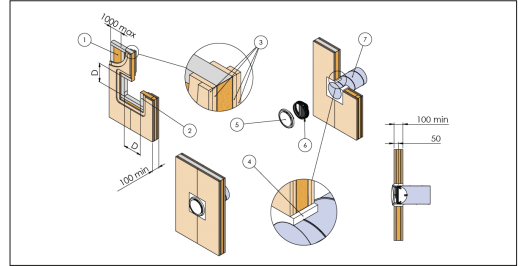

Light wall, transfer, square hole, rock wool with mortar or plaster putty

1. Rock wool density up to 40 kg/m³ (optional)
 2. Metal frame
 3. plasterboard, thickness 12,5 mm type A: FBC1; type F: FBC4 and FBC7 (EN 520)
 4. Mortar or plaster putty
 5. Terminal valve
 6. Fire damper
 7. Ventilation duct
- D from nominal diameter min + 50 to nominal diameter max + 70

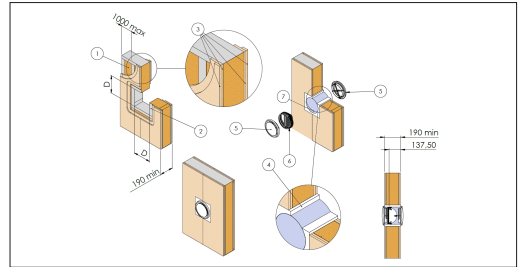

Light wall, ducted on both sides, square hole, rock wool with mortar or plaster putty

1. Rock wool density up to 40 kg/m³ (optional)
2. Metal frame
3. plasterboard, thickness 12,5 mm type A: FBC1; type F: FBC4 and FBC7 (EN 520)
4. Mortar or plaster putty
5. Rock wool, 40 kg/m³
6. Fire damper
7. Ventilation duct
- D from nominal diameter min + 50 to nominal diameter max + 70

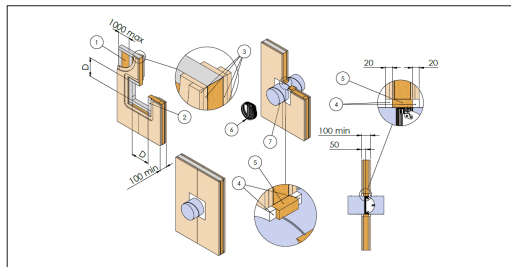

Light wall, ducted on one side, square hole, rock wool with mortar or plaster putty

1. Rock wool density up to 40 kg/m³ (optional)
2. Metal frame
3. plasterboard, thickness 12,5 mm type A: FBC1; type F: FBC4 and FBC7 (EN 520)
4. Mortar or plaster putty
5. Rock wool, 40 kg/m³
6. Terminal valve
7. Fire damper
8. Ventilation duct
- D from nominal diameter min + 50 to nominal diameter max + 70

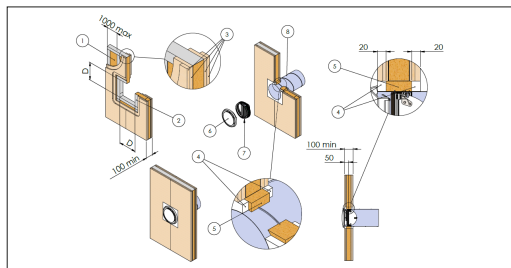

Light wall, transfer, square hole, rock wool with mortar or plaster putty

1. Rock wool density up to 40 kg/m³ (optional)
2. Metal frame
3. plasterboard, thickness 12,5 mm type A: FBC1; type F: FBC4 and FBC7 (EN 520)
4. Mortar or plaster putty
5. Rock wool, 40 kg/m³
6. Terminal valve
7. Fire damper
8. Ventilation duct
- D from nominal diameter min + 50 to nominal diameter max + 70

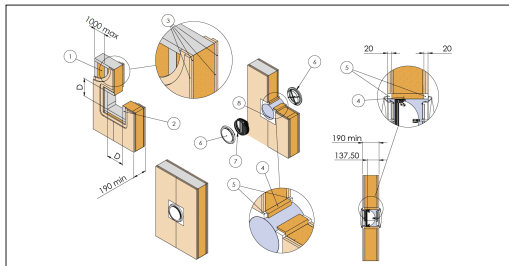

Light wall, ducted both sides, square hole, rock wool with plasterboard - EI60-S - FBC1

1. Rock wool density up to 40 kg/m³ (optional)
2. Metal frame
3. plasterboard, thickness 12,5 mm type A: FBC1; type F: FBC4 and FBC7 (EN 520)
4. Rock wool, 40 kg/m³
5. Fire damper
6. Ventilation duct
7. Self-drilling screw Ø 3,5 X 45 mm
8. Plasterboard arch infill, thickness 12,5 mm or promatect 100 thickness 12 mm
- D from nominal diameter min + 50 to nominal diameter max + 70

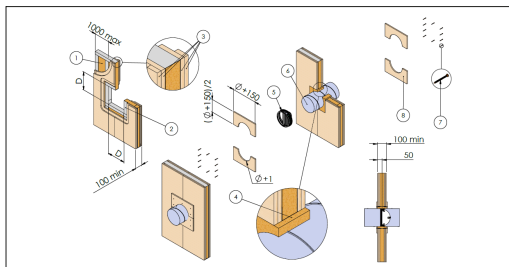

Light wall, ducted both sides, square hole, rock wool with plasterboard - EI90-S - FBC4- EI120-S - FBC7

1. Rock wool density up to 40 kg/m³ (optional)
 2. Metal frame
 3. plasterboard, thickness 12,5 mm type A: FBC1; type F: FBC4 and FBC7 (EN 520)
 4. Rock wool, 40 kg/m³
 5. Fire damper
 6. Ventilation duct
 7. Self-drilling screw \varnothing 3,5 X 45 mm
 8. Plasterboards arch infill type F, thickness 12,5 mm or promatect 100 thickness 12 mm
- D from nominal diameter min + 50 to nominal diameter max + 70

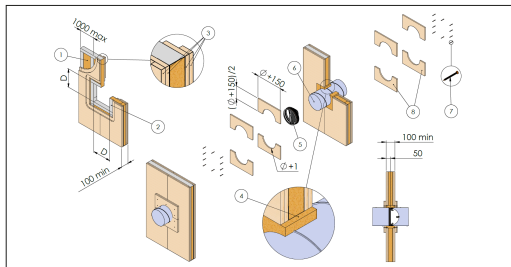

Light wall, ducted one side, square hole, rock wool with plasterboard

1. Rock wool density up to 40 kg/m³ (optional)
 2. Metal frame
 3. plasterboard, thickness 12,5 mm type A: FBC1; type F: FBC4 and FBC7 (EN 520)
 4. Rock wool, 40 kg/m³
 5. Terminal valve
 6. Fire damper
 7. Ventilation duct
 8. Plasterboard arch infill, thickness 12,5 mm or promatect 100 thickness 12 mm
 9. Self-drilling screw \varnothing 3,5 X 45 mm
- D from nominal diameter min + 50 to nominal diameter max + 70

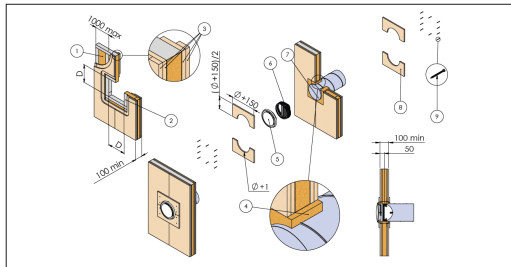

Light wall, transfer, square hole, rock wool with plasterboard

1. Rock wool density up to 40 kg/m³ (optional)
 2. Metal frame
 3. plasterboard, thickness 12,5 mm type A: FBC1; type F: FBC4 and FBC7 (EN 520)
 4. Rock wool, 40 kg/m³
 5. Terminal valve
 6. Fire damper
 7. Ventilation duct
 8. Plasterboard arch infill, thickness 12,5 mm or promatect 100 thickness 12 mm
 9. Self-drilling screw \varnothing 3,5 X 45 mm
- D from nominal diameter min + 50 to nominal diameter max + 70

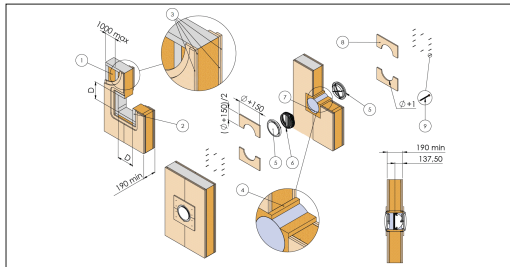

Light wall, ducted both sides, circular hole, mortar or plaster filler

1. Rock wool density up to 40 kg/m³ (optional)
 2. Metal frame
 3. plasterboard, thickness 12,5 mm type A: FBC1; type F: FBC4 and FBC7 (EN 520)
 4. Mortar or plaster putty
 5. Fire damper
 6. Ventilation duct
- D from nominal diameter min + 50 to nominal diameter max + 70

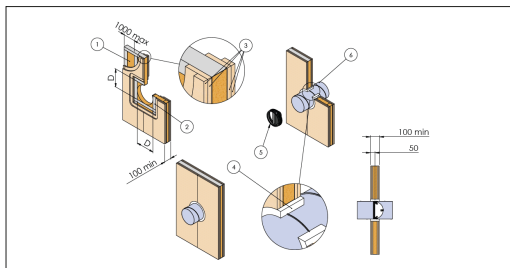

Light wall, ducted one side, circular hole, mortar or plaster putty

1. Rock wool density up to 40 kg/m^3 (optional)
 2. Metal frame
 3. plasterboard, thickness 12,5 mm type A: FBC1; type F: FBC4 and FBC7 (EN 520)
 4. Mortar or plaster putty
 5. Terminal valve
 6. Fire damper
 7. Ventilation duct
- D from nominal diameter min + 50 to nominal diameter max + 70

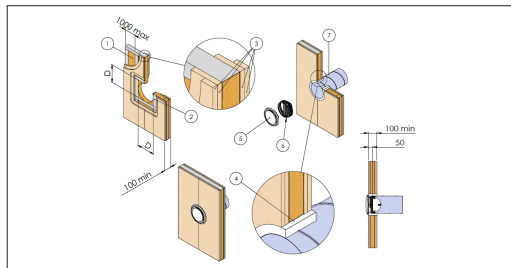

Light wall, ducted one side, circular hole, rock wool with mortar or plaster putty

1. Rock wool density up to 40 kg/m^3 (optional)
 2. Metal frame
 3. plasterboard, thickness 12,5 mm type A: FBC1; type F: FBC4 and FBC7 (EN 520)
 4. Mortar or plaster putty
 5. Terminal valve
 6. Fire damper
 7. Ventilation duct
- D from nominal diameter min + 50 to nominal diameter max + 70

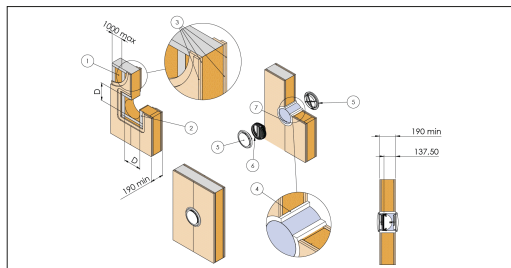

Light wall, ducted both sides, circular hole, rock wool with mortar or plaster filler

1. Rock wool density up to 40 kg/m^3 (optional)
 2. Metal frame
 3. plasterboard, thickness 12,5 mm type A: FBC1; type F: FBC4 and FBC7 (EN 520)
 4. Rock wool, 40 kg/m^3
 5. Mortar or plaster putty
 6. Fire damper
 7. Ventilation duct
- D from nominal diameter min + 50 to nominal diameter max + 70

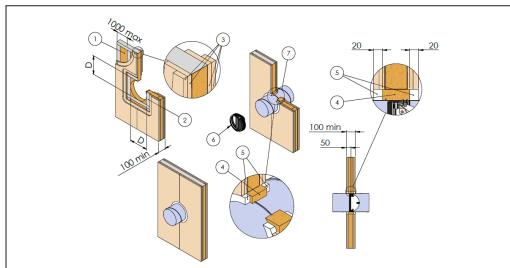

Light wall, ducted one side, circular hole, rock wool with mortar or plaster putty

1. Rock wool density up to 40 kg/m^3 (optional)
 2. Metal frame
 3. plasterboard, thickness 12,5 mm type A: FBC1; type F: FBC4 and FBC7 (EN 520)
 4. Mortar or plaster putty
 5. Rock wool, 40 kg/m^3
 6. Terminal valve
 7. Fire damper
 8. Ventilation duct
- D from nominal diameter min + 50 to nominal diameter max + 70

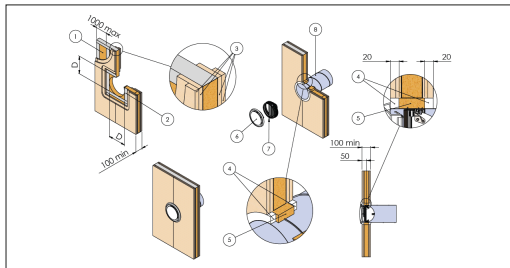

Light wall, transfer, round hole, rock wool with mortar or plaster putty

1. Rock wool density up to 40 kg/m³ (optional)
 2. Metal frame
 3. plasterboard, thickness 12,5 mm type A: FBC1; type F: FBC4 and FBC7 (EN 520)
 4. Rock wool, 40 kg/m³
 5. Mortar or plaster putty
 6. Terminal valve
 7. Fire damper
 8. Ventilation duct
- D from nominal diameter min + 50 to nominal diameter max + 70

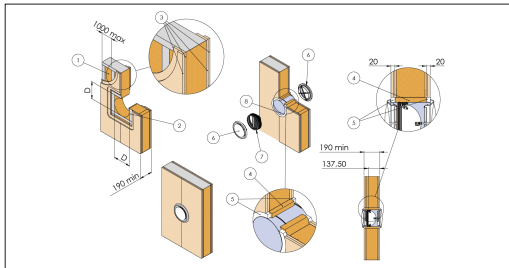

Light wall, ducted both sides, circular hole, rock wool with plasterboard - EI60-S - FBC1

1. Rock wool density up to 40 kg/m³ (optional)
 2. Metal frame
 3. plasterboard, thickness 12,5 mm type A: FBC1; type F: FBC4 and FBC7 (EN 520)
 4. Rock wool, 40 kg/m³
 5. Fire damper
 6. Ventilation duct
 7. Plasterboard arch infill, thickness 12,5 mm or promatect 100 thickness 12 mm
 8. Self-drilling screw \varnothing 3,5 X 45 mm
- D from nominal diameter min + 50 to nominal diameter max + 70

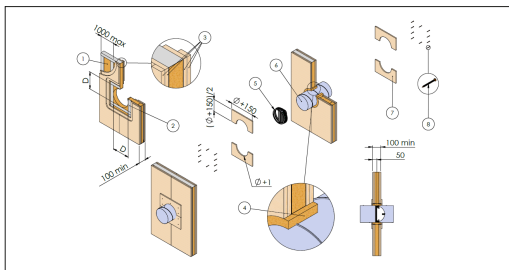

Light wall, ducted both sides, circular hole, rock wool with plasterboard - EI90-S - FBC4 - EI120-S - FBC7

1. Rock wool density up to 40 kg/m³ (optional)
 2. Metal frame
 3. plasterboard, thickness 12,5 mm type A: FBC1; type F: FBC4 and FBC7 (EN 520)
 4. Rock wool, 40 kg/m³
 5. Fire damper
 6. Ventilation duct
 7. Plasterboards arch infill type F, thickness 12,5 mm or promatect 100 thickness 12 mm
 8. Self-drilling screw \varnothing 3,5 X 45 mm
- D from nominal diameter min + 50 to nominal diameter max + 70

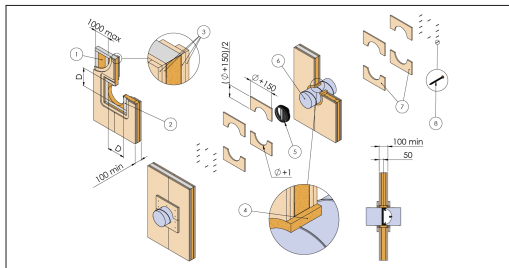

Light wall, ducted one side, circular hole, rock wool with plasterboard

1. Rock wool density up to 40 kg/m³ (optional)
 2. Metal frame
 3. Type A (EN 520) plasterboard thickness 12,5 mm
 4. Rock wool, 40 kg/m³
 5. Terminal valve
 6. Fire damper
 7. Ventilation duct
 8. Plasterboard arch infill, thickness 12,5 mm or promatect 100 thickness 12 mm
 9. Self-drilling screw \varnothing 3,5 X 45 mm
- D from nominal diameter min + 50 to nominal diameter max + 70

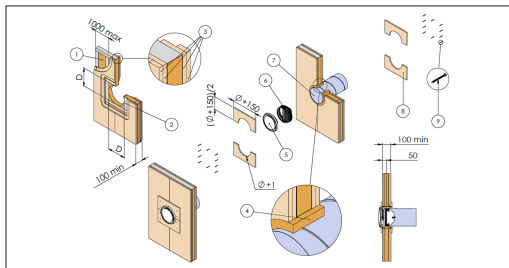

Light wall, transfer, round hole, rock wool with plasterboard

1. Rock wool density up to 40 kg/m³ (optional)
 2. Metal frame
 3. plasterboard, thickness 12,5 mm type A: FBC1; type F: FBC4 and FBC7 (EN 520)
 4. Rock wool, 40 kg/m³
 5. Terminal valve
 6. Fire damper
 7. Ventilation duct
 8. Plasterboard arch infill, thickness 12,5 mm or promatect 100 thickness 12 mm
 9. Self-drilling screw \varnothing 3,5 X 45 mm
- D from nominal diameter min + 50 to nominal diameter max + 70

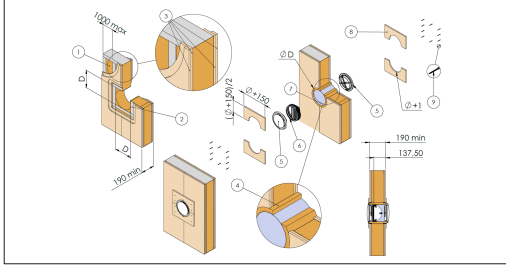

Vertical gypsum block wall installation

Refer to the section Construction supports characteristics for further information.

Comply with the minimum distances indicated on section Minimum distances.

Before and after installation please perform a functional test. Refer to section Mechanism type for further information.

Wall opening

A opening must be provided in the wall as indicated in the drawing.

Damper positioning

Install the fire damper in the ventilation duct as shown in the drawing. Close the blade before installing the fire damper.

Filling

Fill the space between ventilation duct and wall as indicated in the drawing.

Insulation

The walls must be of the same or higher strength class than the damper.

Plaster block wall, ducted on both sides, square hole, mortar or gypsum plaster

1. Mortar or plaster grouting
 2. Fire damper
 3. Ventilation duct
 4. Vertical plaster block wall
- D from nominal diameter min + 50 to nominal diameter max + 70

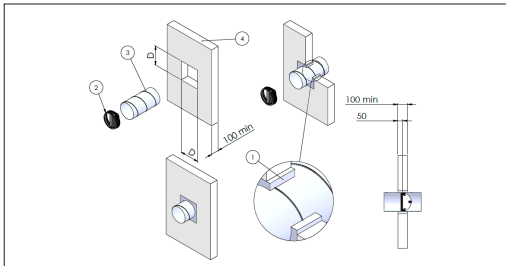

Plaster block wall, ducted one side, square hole, mortar or plaster putty

1. Mortar or plaster grouting
 2. Terminal valve
 3. Fire damper
 4. Ventilation duct
 5. Vertical plaster block wall
- D from nominal diameter min + 50 to nominal diameter max + 70

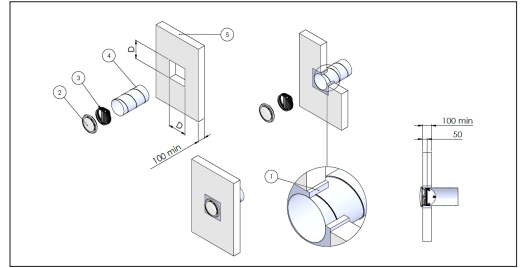

Plaster block wall, transfer, square hole, mortar or plaster putty

1. Mortar or plaster grouting
 2. Terminal valve
 3. Fire damper
 4. Ventilation duct
 5. Vertical plaster block wall
- D from nominal diameter min + 50 to nominal diameter max + 70

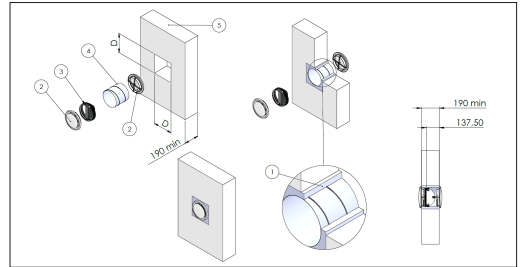

Plaster block wall, ducted both sides, square hole, rock wool with mortar or plaster putty

1. Rock wool, 40 kg/m³
 2. Mortar or plaster grouting
 3. Fire damper
 4. Ventilation duct
 5. Vertical plaster block wall
- D from nominal diameter min + 50 to nominal diameter max + 70

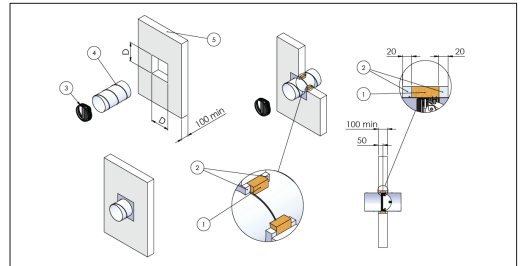

Plaster block wall, ducted one side, square hole, rock wool with mortar or plaster putty

1. Rock wool, 40 kg/m³
2. Mortar or plaster grouting
3. Terminal valve
4. Fire damper
5. Ventilation duct
6. Vertical plaster block wall

D from nominal diameter min + 50 to nominal diameter max + 70

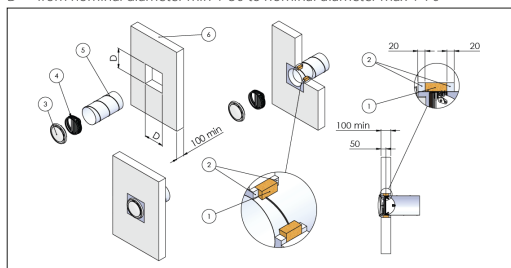

plaster block wall, transfer, square hole, rock wool with mortar or plaster putty

1. Mortar or plaster grouting
2. Rock wool, 40 kg/m³
3. Terminal valve
4. Fire damper
5. Ventilation duct
6. Vertical plaster block wall

D from nominal diameter min + 50 to nominal diameter max + 70

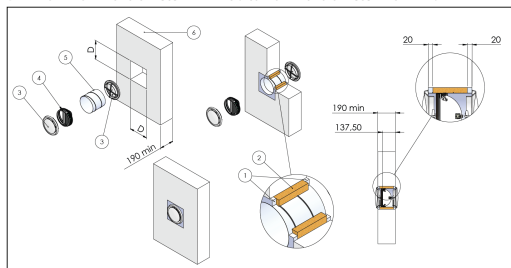

Plaster block wall, ducted both sides, square hole, rock wool plasterboard - EI60-S - FBC1

1. Rock wool, 40 kg/m³
2. Fire damper
3. Ventilation duct
4. Vertical plaster block wall
5. Plasterboard arch infill, thickness 12,5 mm or promatect 100 thickness 12 mm
6. Self-drilling screw \varnothing 3,5 X 45 mm

D from nominal diameter min + 50 to nominal diameter max + 70

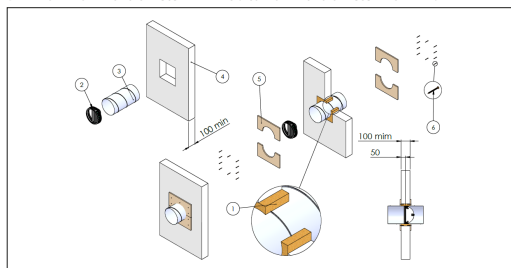

Plaster block wall, ducted both sides, square hole, rock wool plasterboard - EI90-S - FBC4- EI120-S - FBC7

1. Rock wool, 40 kg/m³
2. Fire damper
3. Ventilation duct
4. Vertical plaster block wall
5. Plasterboards arch infill type F, thickness 12,5 mm or promatect 100 thickness 12 mm
6. Self-drilling screw \varnothing 3,5 X 45 mm

D from nominal diameter min + 50 to nominal diameter max + 70

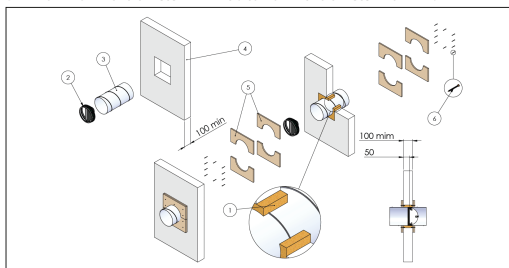

Plaster block wall, ducted one side, square hole, rock wool with plasterboard

1. Rock wool, 40 kg/m³
2. Terminal valve
3. Fire damper
4. Ventilation duct
5. Vertical plaster block wall
6. Plasterboard arch infill, thickness 12,5 mm or promatect 100 thickness 12 mm
7. Self-drilling screw \varnothing 3,5 X 45 mm

D from nominal diameter min + 50 to nominal diameter max + 70

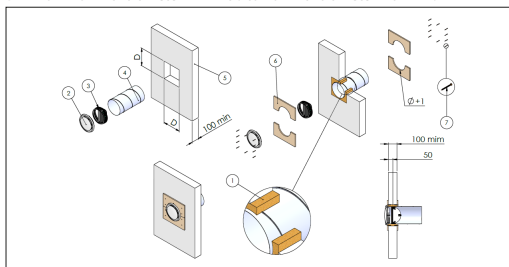

Wall plaster blocks, transfer, square hole, rock wool plaster-board

1. Rock wool, 40 kg/m³
 2. Terminal valve
 3. Fire damper
 4. Ventilation duct
 5. Vertical plaster block wall
 6. Plasterboard arch infill, thickness 12,5 mm or promatect 100 thickness 12 mm
 7. Self-drilling screw \varnothing 3,5 X 45 mm
- D from nominal diameter min + 50 to nominal diameter max + 70

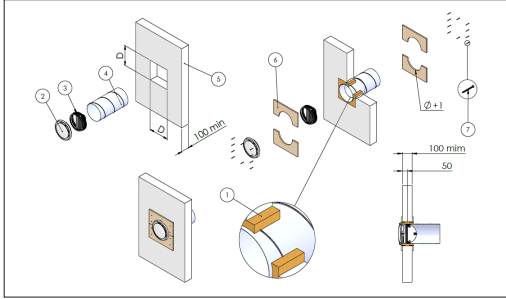

Plaster block wall, ducted on both sides, circular hole, mortar or plaster putty

1. Mortar or plaster grouting
 2. Fire damper
 3. Ventilation duct
 4. Vertical plaster block wall
- D from nominal diameter min + 50 to nominal diameter max + 70

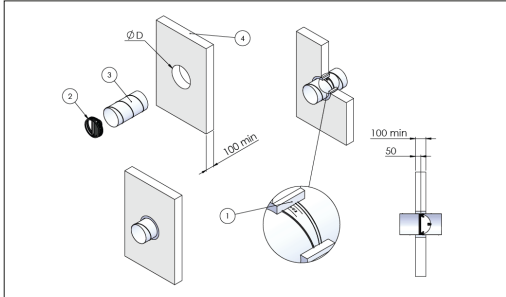

Plaster block wall, ducted one side, circular hole, mortar or plaster putty

1. Mortar or plaster grouting
 2. Terminal valve
 3. Fire damper
 4. Ventilation duct
 5. Vertical plaster block wall
- D from nominal diameter min + 50 to nominal diameter max + 70

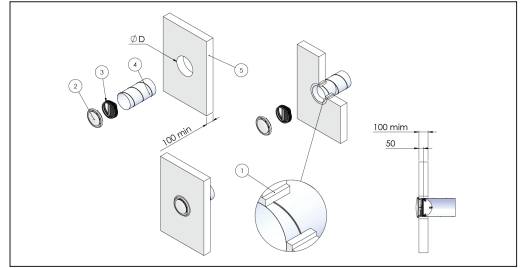

Wall plaster blocks, transfer, circular hole, mortar or plaster putty

1. Mortar or plaster grouting
 2. Terminal valve
 3. Fire damper
 4. Ventilation duct
 5. Vertical plaster block wall
- D from nominal diameter min + 50 to nominal diameter max + 70

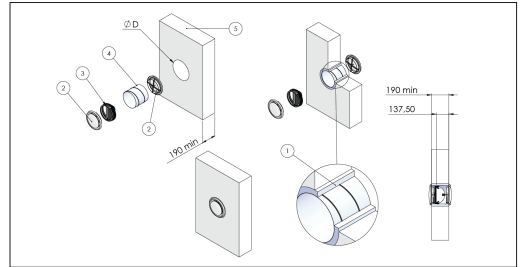

Wall plaster blocks, transfer, circular hole, mortar or plaster putty

1. Rock wool, 40 kg/m³
 2. Mortar or plaster grouting
 3. Fire damper
 4. Ventilation duct
 5. Vertical plaster block wall
- D from nominal diameter min + 50 to nominal diameter max + 70

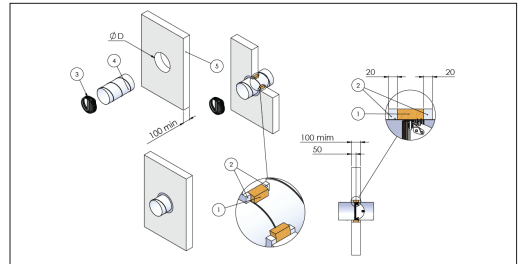

Wall plaster blocks, transfer, circular hole, mortar or plaster putty

1. Rock wool, 40 kg/m³
 2. Mortar or plaster grouting
 3. Terminal valve
 4. Fire damper
 5. Ventilation duct
 6. Vertical plaster block wall
- D from nominal diameter min + 50 to nominal diameter max + 70

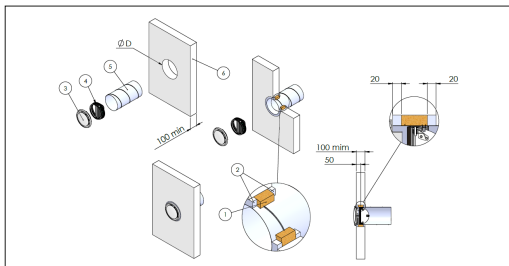

Wall plaster blocks, transfer, circular hole, mortar or plaster putty

1. Mortar or plaster grouting
 2. Rock wool, 40 kg/m³
 3. Terminal valve
 4. Fire damper
 5. Ventilation duct
 6. Vertical plaster block wall
- D from nominal diameter min + 50 to nominal diameter max + 70

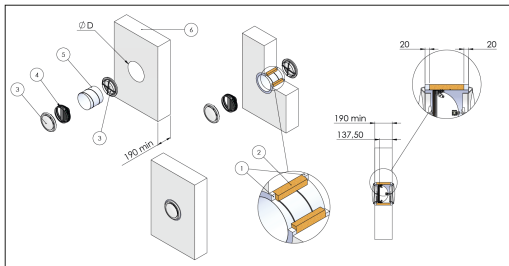

Plaster block wall, ducted both sides, circular hole, rock wool with plasterboard - EI60-S - FBC1

1. Rock wool, 40 kg/m³
 2. Fire damper
 3. Ventilation duct
 4. Vertical plaster block wall
 5. Plasterboard arch infill, thickness 12,5 mm or promatect 100 thickness 12 mm
 6. Self-drilling screw \varnothing 3,5 X 45 mm
- D from nominal diameter min + 50 to nominal diameter max + 70

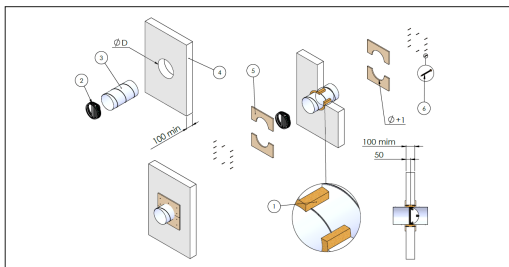

Plaster block wall, ducted both sides, circular hole, rock wool plasterboard - EI90-S - FBC4- EI120-S - FBC7

1. Rock wool, 40 kg/m³
 2. Fire damper
 3. Ventilation duct
 4. Vertical plaster block wall
 5. Plasterboards arch infill type F, thickness 12,5 mm or promatect 100 thickness 12 mm
 6. Self-drilling screw \varnothing 3,5 X 45 mm
- D from nominal diameter min + 50 to nominal diameter max + 70

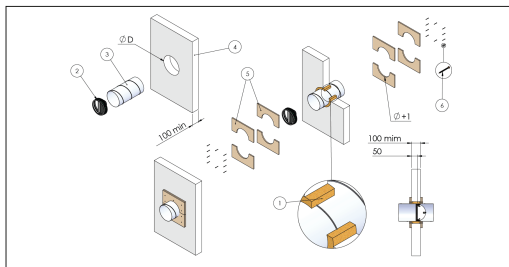

Wall plaster blocks, transfer, circular hole, mortar or plaster putty

1. Rock wool, 40 kg/m³
 2. Terminal valve
 3. Fire damper
 4. Ventilation duct
 5. Vertical plaster block wall
 6. Plasterboard arch infill, thickness 12,5 mm or promatect 100 thickness 12 mm
 7. Self-drilling screw \varnothing 3,5 X 45 mm
- D from nominal diameter min + 50 to nominal diameter max + 70

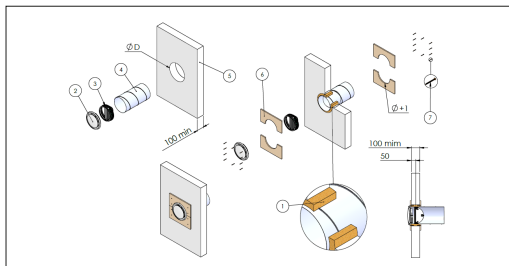

Wall plaster blocks, transfer, circular hole, mortar or plaster putty

1. Rock wool, 40 kg/m³
 2. Terminal valve
 3. Fire damper
 4. Ventilation duct
 5. Vertical plaster block wall
 6. Plasterboard arch infill, thickness 12,5 mm or promatect 100 thickness 12 mm
 7. Self-drilling screw Ø 3,5 X 45 mm
- D from nominal diameter min + 50 to nominal diameter max + 70

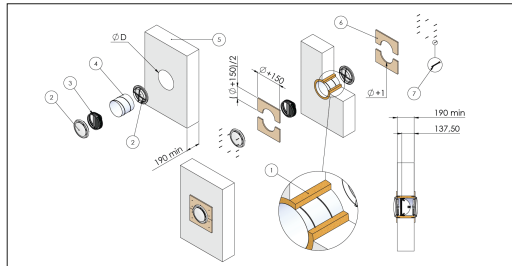

Lightweight vertical safety wall installations (plasterboard)

Refer to the section Construction supports characteristics for further information.

Comply with the minimum distances indicated on section Minimum distances .

Before and after installation please perform a functional test. Refer to section Mechanism type for further information .

Wall opening

An opening must be provided in the wall as indicated in the drawing.

Damper positioning

Install the fire damper in the ventilation duct as shown in the drawing.

Close the blade before installing the fire damper.

Filling

Fill the space between ventilation duct and wall as indicated in the drawing.

Insulation

Only in the case of a light vertical wall with two dampers closer than 200 mm and rock wool sealing, bands BELT-FBC-Ø are required on both sides of the wall or shaft, only on the accessible side. With other sealings they are not necessary.

Lightweight safety wall, ducted on both sides, square hole, mortar or gypsum plaster

1. Rock wool density up to 40 kg/m³ (optional)
 2. Metal frame
 3. plasterboard, thickness 12,5 mm type A: FBC1; type F: FBC4 and FBC7 (EN 520)
 4. Metal foil 0,5 mm thick
 5. Mortar or plaster putty
 6. Fire damper
 7. Ventilation duct
- D from nominal diameter min + 50 to nominal diameter max + 70

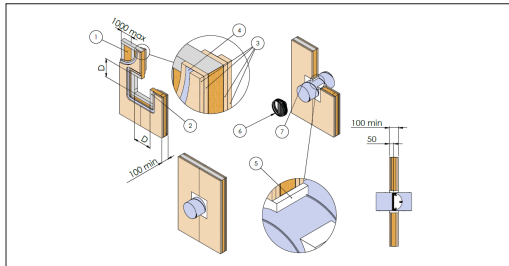

Lightweight safety wall, ducted one side, square hole, mortar or plaster putty

1. Rock wool density up to 40 kg/m³ (optional)
 2. Metal frame
 3. plasterboard, thickness 12,5 mm type A: FBC1; type F: FBC4 and FBC7 (EN 520)
 4. Metal foil 0,5 mm thick
 5. Mortar or plaster putty
 6. Terminal valve
 7. Fire damper
 8. Ventilation duct
- D from nominal diameter min + 50 to nominal diameter max + 70

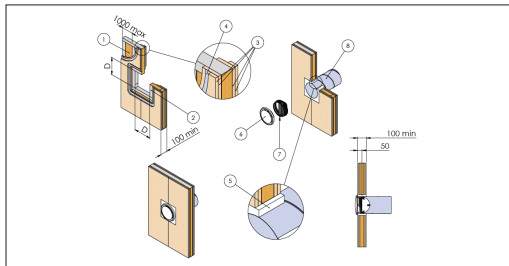

Light security wall, transfer, square hole, mortar or plaster putty

1. Rock wool density up to 40 kg/m^3 (optional)
2. Metal frame
3. plasterboard, thickness 12,5 mm type A: FBC1; type F: FBC4 and FBC7 (EN 520)
4. Metal foil 0.5 mm thick
5. Mortar or plaster putty
6. Terminal valve
7. Fire damper
8. Ventilation duct
- D from nominal diameter min + 50 to nominal diameter max + 70

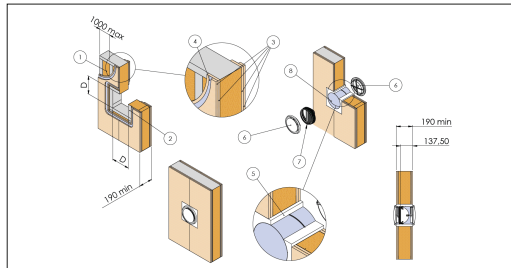

Light safety wall, ducted both sides, square hole, rock wool with mortar or gypsum plaster

1. Rock wool density up to 40 kg/m^3 (optional)
2. Metal frame
3. plasterboard, thickness 12,5 mm type A: FBC1; type F: FBC4 and FBC7 (EN 520)
4. Foil thickness 0.5 mm
5. Mortar or plaster putty
6. Rock wool, 40 kg/m^3
7. Fire damper
8. Ventilation duct
- D from nominal diameter min + 50 to nominal diameter max + 70

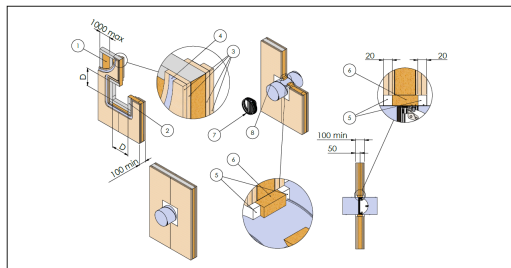

Light safety wall, ducted one side, square hole, rock wool with mortar or gypsum plaster

1. Rock wool density up to 40 kg/m^3 (optional)
2. Metal frame
3. plasterboard, thickness 12,5 mm type A: FBC1; type F: FBC4 and FBC7 (EN 520)
4. Foil thickness 0.5 mm
5. Mortar or plaster putty
6. Rock wool, 40 kg/m^3
7. Terminal valve
8. Fire damper
9. Ventilation duct
- D from nominal diameter min + 50 to nominal diameter max + 70

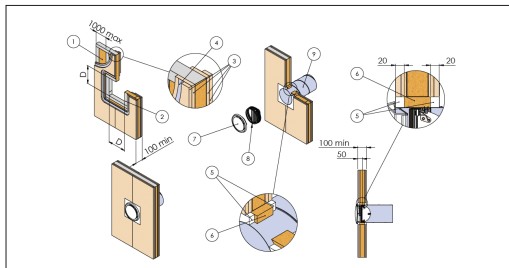

Light wall, transfer, square hole, rock wool with mortar or plaster putty

1. Rock wool density up to 40 kg/m^3 (optional)
2. Metal frame
3. plasterboard, thickness 12,5 mm type A: FBC1; type F: FBC4 and FBC7 (EN 520)
4. Foil thickness 0.5 mm
5. Mortar or plaster putty
6. Rock wool, 40 kg/m^3
7. Terminal valve
8. Fire damper
9. Ventilation duct
- D from nominal diameter min + 50 to nominal diameter max + 70

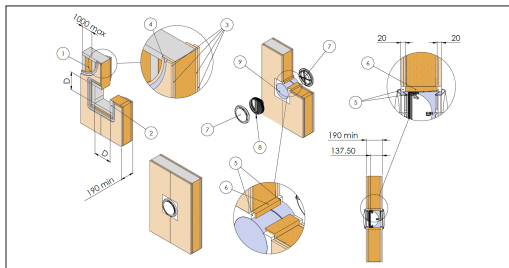

Light safety wall, ducted both sides, square hole, rock wool with plasterboard - EI60-S - FBC1

1. Rock wool density up to 40 kg/m³ (optional)
2. Metal frame
3. plasterboard, thickness 12,5 mm type A: FBC1; type F: FBC4 and FBC7 (EN 520)
4. Foil thickness 0,5 mm
5. Rock wool, 40 kg/m³
6. Fire damper
7. Ventilation duct
8. Plasterboard arch infill, thickness 12,5 mm or promatect 100 thickness 12 mm
9. Self-drilling screw \varnothing 3,5 X 45 mm
- D from nominal diameter min + 50 to nominal diameter max + 70

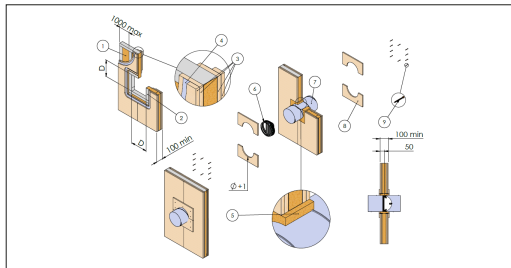

Light safety wall, ducted both sides, square hole, rock wool with plasterboard - EI90-S - FBC4- EI120-S - FBC7

1. Rock wool density up to 40 kg/m³ (optional)
2. Metal frame
3. plasterboard, thickness 12,5 mm type A: FBC1; type F: FBC4 and FBC7 (EN 520)
4. Foil thickness 0,5 mm
5. Rock wool, 40 kg/m³
6. Fire damper
7. Ventilation duct
8. Plasterboards arch infill type F, thickness 12,5 mm or promatect 100 thickness 12 mm
9. Self-drilling screw \varnothing 3,5 X 45 mm
- D from nominal diameter min + 50 to nominal diameter max + 70

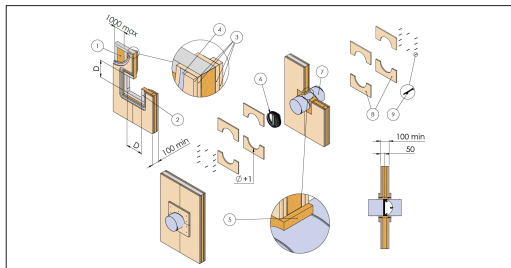

Light safety wall, ducted one side, square hole, rock wool with plasterboard

1. Rock wool density up to 40 kg/m³ (optional)
2. Metal frame
3. plasterboard, thickness 12,5 mm type A: FBC1; type F: FBC4 and FBC7 (EN 520)
4. Foil thickness 0,5 mm
5. Rock wool, 40 kg/m³
6. Terminal valve
7. Fire damper
8. Ventilation duct
9. Plasterboard arch infill, thickness 12,5 mm or promatect 100 thickness 12 mm
10. Self-drilling screw \varnothing 3,5 X 45 mm
- D from nominal diameter min + 50 to nominal diameter max + 70

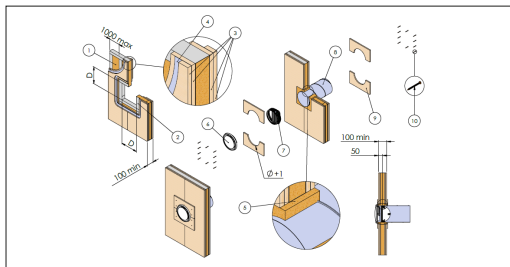

Light safety wall, transfer, square hole, rock wool with plasterboard

1. Rock wool density up to 40 kg/m³ (optional)
2. Metal frame
3. plasterboard, thickness 12,5 mm type A: FBC1; type F: FBC4 and FBC7 (EN 520)
4. Foil thickness 0,5 mm
5. Rock wool, 40 kg/m³
6. Terminal valve
7. Fire damper
8. Ventilation duct
9. Plasterboard arch infill, thickness 12,5 mm or promatect 100 thickness 12 mm
10. Self-drilling screw \varnothing 3,5 X 45 mm
- D from nominal diameter min + 50 to nominal diameter max + 70

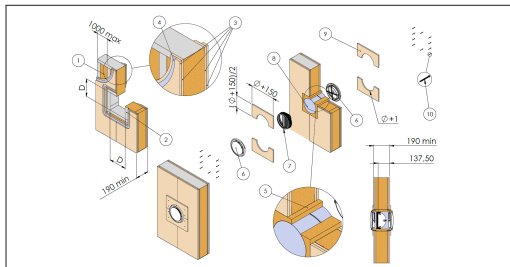

Light safety wall, ducted on both sides, circular hole, mortar or plaster putty

1. Rock wool density up to 40 kg/m³ (optional)
 2. Metal frame
 3. plasterboard, thickness 12,5 mm type A: FBC1; type F: FBC4 and FBC7 (EN 520)
 4. Metal foil 0.5 mm thick
 5. Mortar or plaster putty
 6. Fire damper
 7. Ventilation duct
- D from nominal diameter min + 50 to nominal diameter max + 70

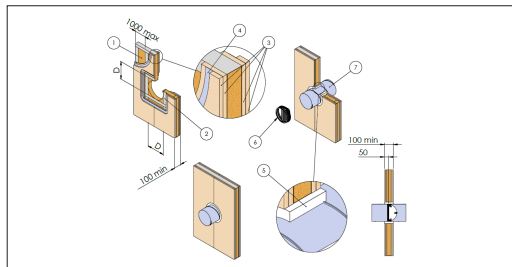

Light safety wall, ducted one side, circular hole, mortar or plaster putty

1. Rock wool density up to 40 kg/m³ (optional)
 2. Metal frame
 3. plasterboard, thickness 12,5 mm type A: FBC1; type F: FBC4 and FBC7 (EN 520)
 4. Metal foil 0.5 mm thick
 5. Mortar or plaster putty
 6. Terminal valve
 7. Fire damper
 8. Ventilation duct
- D from nominal diameter min + 50 to nominal diameter max + 70

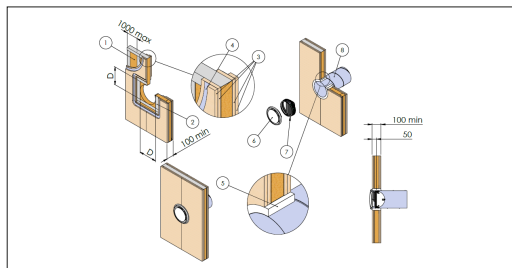

Light security wall, transfer, round hole, mortar or plaster putty

1. Rock wool density up to 40 kg/m³ (optional)
 2. Metal frame
 3. plasterboard, thickness 12,5 mm type A: FBC1; type F: FBC4 and FBC7 (EN 520)
 4. Metal foil 0.5 mm thick
 5. Mortar or plaster putty
 6. Terminal valve
 7. Fire damper
 8. Ventilation duct
- D from nominal diameter min + 50 to nominal diameter max + 70

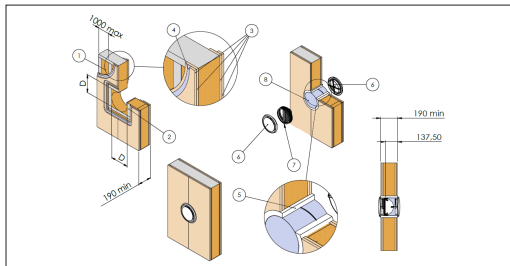

Light safety wall, ducted both sides, circular hole, rock wool with mortar or plaster putty

1. Rock wool density up to 40 kg/m³ (optional)
 2. Metal frame
 3. plasterboard, thickness 12,5 mm type A: FBC1; type F: FBC4 and FBC7 (EN 520)
 4. Foil thickness 0.5 mm
 5. Rock wool, 40 kg/m³
 6. Mortar or plaster putty
 7. Fire damper
 8. Ventilation duct
- D from nominal diameter min + 50 to nominal diameter max + 70

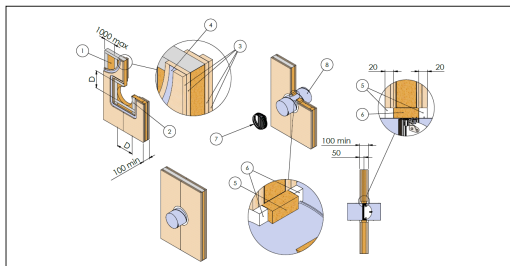

Light safety wall, ducted one side, circular hole, rock wool with mortar or plaster putty

1. Rock wool density up to 40 kg/m³ (optional)
 2. Metal frame
 3. plasterboard, thickness 12,5 mm type A: FBC1; type F: FBC4 and FBC7 (EN 520)
 4. Foil thickness 0,5 mm
 5. Mortar or plaster putty
 6. Rock wool, 40 kg/m³
 7. Terminal valve
 8. Fire damper
 9. Ventilation duct
- D from nominal diameter min + 50 to nominal diameter max + 70

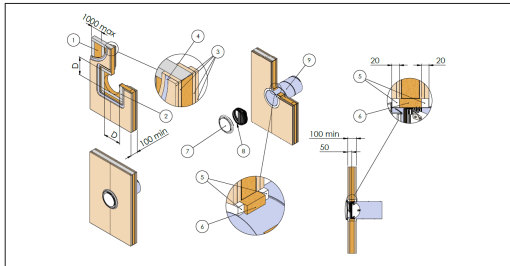

Light safety wall, transfer, round hole, rock wool with mortar or plaster putty

1. Rock wool density up to 40 kg/m³ (optional)
 2. Metal frame
 3. plasterboard, thickness 12,5 mm type A: FBC1; type F: FBC4 and FBC7 (EN 520)
 4. Foil thickness 0,5 mm
 5. Mortar or plaster putty
 6. Rock wool, 40 kg/m³
 7. Terminal valve
 8. Fire damper
 9. Ventilation duct
- D from nominal diameter min + 50 to nominal diameter max + 70

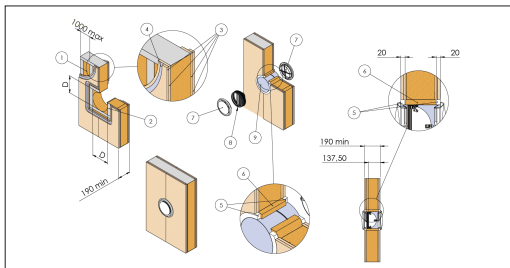

Light safety wall, ducted both sides, circular hole, rock wool with plasterboard - EI60-S - FBC1

1. Rock wool density up to 40 kg/m³ (optional)
 2. Metal frame
 3. plasterboard, thickness 12,5 mm type A: FBC1; type F: FBC4 and FBC7 (EN 520)
 4. Foil thickness 0,5 mm
 5. Rock wool, 40 kg/m³
 6. Fire damper
 7. Ventilation duct
 8. Plasterboard arch infill, thickness 12,5 mm or promatect 100 thickness 12 mm
 9. Self-drilling screw \varnothing 3,5 X 45 mm
- D from nominal diameter min + 50 to nominal diameter max + 70

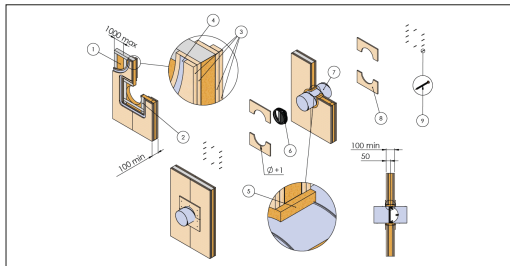

Light wall, ducted both sides, square hole, rock wool with plasterboard - EI90-S - FBC4 - EI120-S - FBC7

1. Rock wool density up to 40 kg/m³ (optional)
 2. Metal frame
 3. plasterboard, thickness 12,5 mm type A: FBC1; type F: FBC4 and FBC7 (EN 520)
 4. Foil thickness 0,5 mm
 5. Rock wool, 40 kg/m³
 6. Fire damper
 7. Ventilation duct
 8. Plasterboards arch infill type F, thickness 12,5 mm or promatect 100 thickness 12 mm
 9. Self-drilling screw \varnothing 3,5 X 45 mm
- D from nominal diameter min + 50 to nominal diameter max + 70

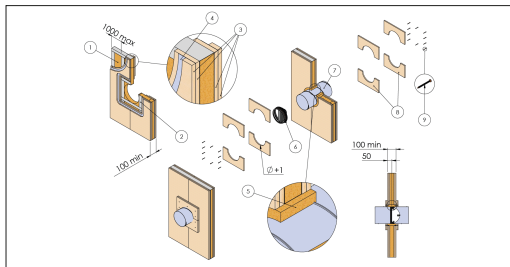

Light safety wall, ducted one side, circular hole, rock wool with plasterboard

1. Rock wool density up to 40 kg/m³ (optional)
 2. Metal frame
 3. plasterboard, thickness 12,5 mm type A: FBC1; type F: FBC4 and FBC7 (EN 520)
 4. Foil thickness 0,5 mm
 5. Rock wool, 40 kg/m³
 6. Terminal valve
 7. Fire damper
 8. Ventilation duct
 9. Plasterboard arch infill, thickness 12,5 mm or promatect 100 thickness 12 mm
 10. Self-drilling screw \varnothing 3,5 X 45 mm
- D from nominal diameter min + 50 to nominal diameter max + 70

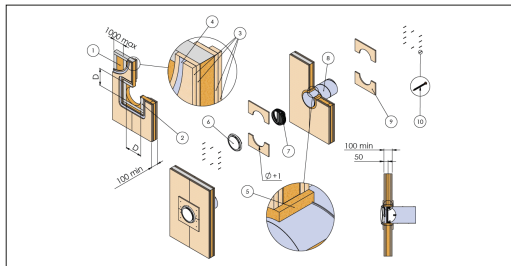

Light safety wall, transfer, round hole, rock wool with plasterboard

1. Rock wool density up to 40 kg/m³ (optional)
 2. Metal frame
 3. plasterboard, thickness 12,5 mm type A: FBC1; type F: FBC4 and FBC7 (EN 520)
 4. Foil thickness 0,5 mm
 5. Rock wool, 40 kg/m³
 6. Terminal valve
 7. Fire damper
 8. Ventilation duct
 9. Plasterboard arch infill, thickness 12,5 mm or promatect 100 thickness 12 mm
 10. Self-drilling screw \varnothing 3,5 X 45 mm
- D from nominal diameter min + 50 to nominal diameter max + 70

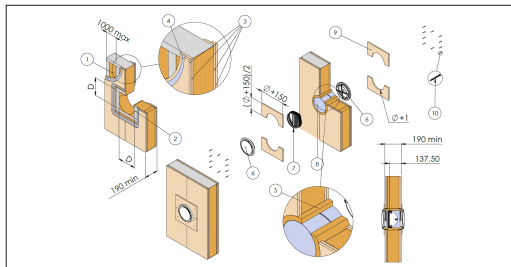

■ Installations within floor

Refer to the section Construction supports characteristics for further information.

Comply with the minimum distances indicated on section Minimum distances.

Before and after installation please perform a functional test. Refer to section Mechanism type for further information.

■ Floor opening

A opening must be provided in the floor as indicated in the drawing.

■ Damper positioning

Install the fire damper in the ventilation duct as shown in the drawing.

Close the blade before installing the fire damper.

■ Filling

Fill the space between ventilation duct and wall as indicated in the drawing.

■ Insulation

The floor must have a fire resistance class greater than or equal to that of the damper

Floor, ducted both sides, square hole mortar or plaster filler

1. Mortar or plaster putty
 2. Floor
 3. Fire damper
 4. Ventilation duct
- D From nominal diameter min + 0 to nominal diameter max + 70
S = min 100 mm for FBC1
= min 150 mm for FBC4, FBC7
L = 50 mm for FBC1
= 75 mm for FBC4, FBC7

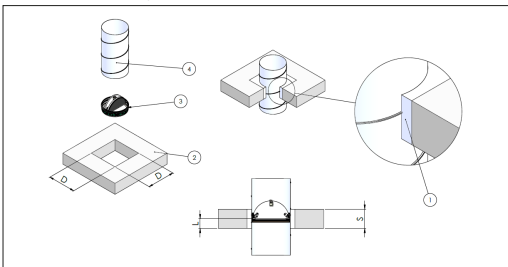

Floor, channelled one side, square hole mortar or plaster filler

1. Mortar or plaster putty
 2. Terminal valve
 3. Floor
 4. Fire damper
 5. Ventilation duct
- D From nominal diameter min + 0 to nominal diameter max + 70
S = min 100 mm for FBC1
= min 150 mm for FBC4, FBC7
L = 50 mm for FBC1
= 75 mm for FBC4, FBC7

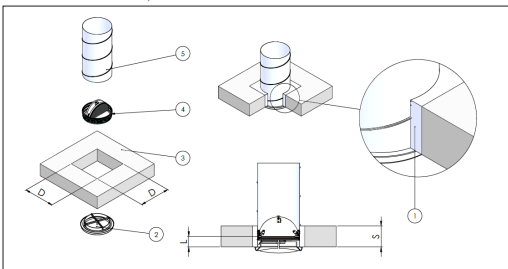

Floor, transfer, square hole mortar or plaster putty

1. Mortar or plaster putty
 2. Terminal valve
 3. Floor
 4. Fire damper
 5. Ventilation duct
- D From nominal diameter min + 0 to nominal diameter max + 70
 S = min 275 mm
 L = 137,50 mm

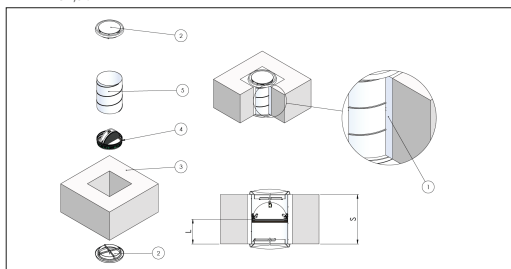

floor, ducted both sides, circular hole mortar or plaster filler

1. Mortar or plaster putty
 2. Floor
 3. Fire damper
 4. Ventilation duct
- D From nominal diameter min + 0 to nominal diameter max + 70
 S = min 100 mm for FBC1
 = min 150 mm for FBC4, FBC7
 L = 50 mm for FBC1
 = 75 mm for FBC4, FBC7

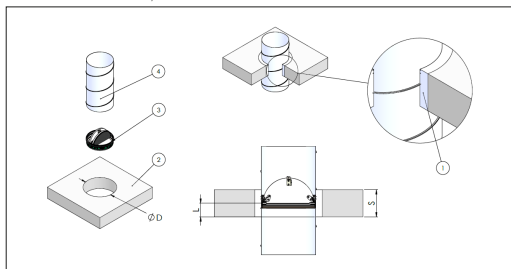

floor, ducted one side, circular hole mortar or plaster filler

1. Mortar or plaster putty
 2. Terminal valve
 3. Floor
 4. Fire damper
 5. Ventilation duct
- D From nominal diameter min + 0 to nominal diameter max + 70
 S = min 100 mm for FBC1
 = min 150 mm for FBC4, FBC7
 L = 50 mm for FBC1
 = 75 mm for FBC4, FBC7

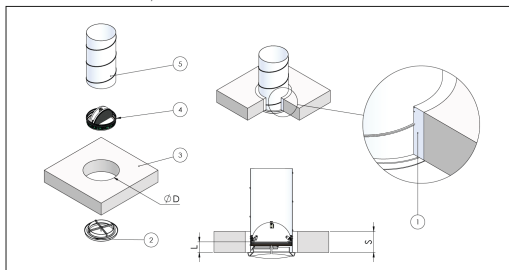

Floor, transfer, circular hole mortar or plaster putty

1. Mortar or plaster putty
 2. Terminal valve
 3. Floor
 4. Fire damper
 5. Ventilation duct
- D From nominal diameter min + 0 to nominal diameter max + 70
 S = min 275 mm
 L = 137,50 mm

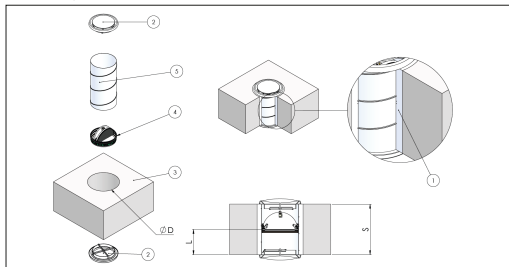

■ Installations within vertical wall with Fire Batt (Weichschott) sealing

Refer to the section Construction supports characteristics for further information.
 Comply with the minimum distances indicated on section Minimum distances.
 Before and after installation please perform a functional test. Refer to section Mechanism type for further information.

▣ Wall opening

A opening must be provided in the wall as indicated in the drawing.

▣ Damper positioning

Install the fire damper in the ventilation duct as shown in the drawing.

The fire damper has to be fixed at the bottom and suspended from the ceiling.

Close the blade before installing the fire damper.

▣ Filling

Fill the space between the damper and the wall using Fire Batt (Weichschott) sealing made from two rock wool panels with minimum thickness of 50 mm and minimum density of 140 kg/m³. The panels must be covered on both faces of the wall with endothermic varnish type PROMASTOP E PASTE or HILTI CFS-CT (mini-

mum thickness of 1 mm) and with an internal perimeter sealant type PROMASTOP E PASTE or HILTI CFS-S ACR (minimum thickness of 1 mm).

Insulation

The wall must be of the same or higher strength class than the damper.

Weichschott wall, ducted on both sides

1. Rock wool panel 50 mm thick with 140 kg/m³ density.
 2. PROMASTOP E PASTE or HILTI CFS-S ACR type sealant
 3. PROMASTOP E PASTE or HILTI CFS-CT endothermic varnish
 4. Ventilation duct
 5. Fire damper
 6. Vertical rigid wall density ≥ 550 kg/m³ or vertical light wall (plasterboard) type A (FBC1) ; type F: FBC4 and FBC7 (EN 520)
- D nominal diameter + 600 max

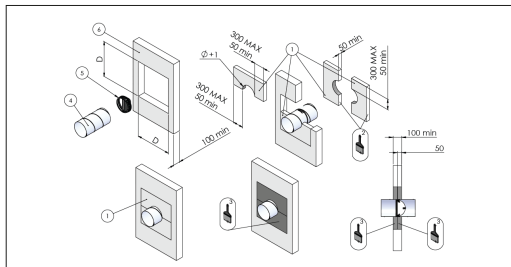

Weichschott wall, ducted on both sides

1. Rock wool panel 50 mm thick with 140 kg/m³ density.
 2. PROMASTOP E PASTE or HILTI CFS-S ACR type sealant
 3. PROMASTOP E PASTE or HILTI CFS-CT endothermic varnish
 4. Terminal valve
 5. Ventilation duct
 6. Fire damper
 7. Vertical rigid wall density ≥ 550 kg/m³ or vertical light wall (plasterboard) type A (FBC1) ; type F: FBC4 and FBC7 (EN 520)
- D nominal diameter + 600 max

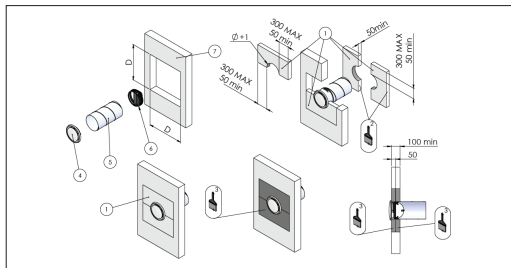

weichschott wall, transfer

1. Rock wool panel with thickness 137.50 mm and density 140 kg/m³
 2. PROMASTOP E PASTE or HILTI CFS-S ACR type sealant
 3. PROMASTOP E PASTE or HILTI CFS-CT endothermic varnish
 4. Terminal valve
 5. Ventilation duct
 6. Fire damper
 7. Vertical rigid wall density ≥ 550 kg/m³ or vertical light wall (plasterboard) type A (FBC1) ; type F: FBC4 and FBC7 (EN 520)
- D nominal diameter + 600 max

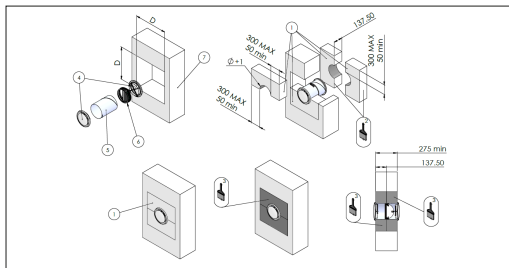

Installation within floor with Fire Batt (Weichschott) sealing
Refer to the section Construction supports characteristics for further information.
Comply with the minimum distances indicated on section Minimum distances .
Before and after installation please perform a functional test. Refer to section Mechanism type for further information .

Floor opening

A opening must be provided in the floor as indicated in the drawing.

Damper positioning

Position the damper in the opening so that the side of the closing mechanism extends as indicated in the drawing.
The mechanism can be located both above and below the floor.
Close the blade before installing the fire damper.

Filling

Fill the space between the damper and the floor using Fire Batt (Weichschott) sealing made from two rock wool panels with minimum thickness of 50 mm and minimum density of 140 kg/m³.
The panels must be covered on both faces of the wall with endothermic varnish type PROMASTOP E PASTE or HILTI CFS-CT (minimum thickness of 1 mm) and with an internal perimeter sealant type PROMASTOP E PASTE or HILTI CFS-S ACR (minimum thickness of 1 mm).

Insulation

The floor must have a fire resistance class greater than or equal to that of the damper

Weichschott floor, ducted on both sides

1. Rock wool panel 50 mm thick with 140 kg/m³ density.
 2. PROMASTOP E PASTE or HILTI CFS-S ACR type sealant
 3. PROMASTOP E PASTE or HILTI CFS-CT endothermic varnish
 4. Floor
 5. Fire damper
 6. Ventilation duct
- D Nominal diameter + 600 max
 S = min 100 mm for FBC1
 = min 150 mm for FBC4, FBC7
- L = 50 mm for FBC1
 = 75 mm for FBC4, FBC7

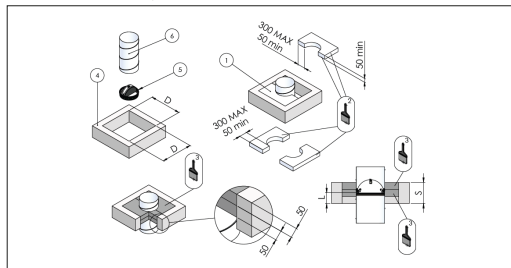

Weichschott floor, ducted one side

1. Rock wool panel with thickness 137.50 mm and density 140 kg/m³
 2. PROMASTOP E PASTE or HILTI CFS-S ACR type sealant
 3. PROMASTOP E PASTE or HILTI CFS-CT endothermic varnish
 4. Terminal valve
 5. Floor
 6. Fire damper
 7. Ventilation duct
- D Nominal diameter + 600 max
 S = min 275 mm
 L = 137,50 mm

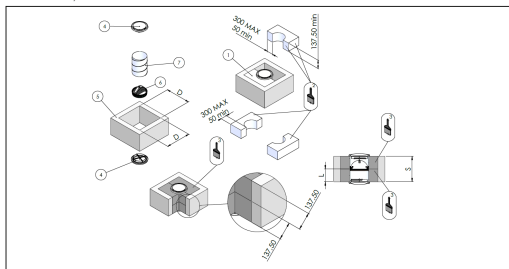

Weichschott floor, ducted one side

1. Rock wool panel 50 mm thick with 140 kg/m³ density.
 2. PROMASTOP E PASTE or HILTI CFS-S ACR type sealant
 3. PROMASTOP E PASTE or HILTI CFS-CT endothermic varnish
 4. Terminal valve
 5. Floor
 6. Fire damper
 7. Ventilation duct
- D Nominal diameter + 600 max
 S = min 100 mm for FBC1
 = min 150 mm for FBC4, FBC7
- L = 50 mm for FBC1
 = 75 mm for FBC4, FBC7

