

Lindab **Atrium / Loggia**

Radiant cooling- and heating panels
Installation instructions



Installation instruction

Atrium / Loggia

1. Content.....	2
1.1 Symbols.....	3
2. Control of delivery.....	3
2.1 Before starting.....	3
2.2 Safe operation.....	3
2.3 Receipt of goods.....	3
2.4 Unloading of goods.....	3
2.5 Handling / Carrying.....	3
2.6 Tools.....	4
2.7 Installation.....	4
2.8 Where to find additional instructions or technical documentation.....	4
2.9 Cleaning after assembly / before commissioning..	4
2.10 Packing, unpacking guideline	5
2.11 Product labelling.....	6
2.12 Order code	6
2.13 Order code examples.....	6
2.14 Label.....	6
2.15 Contents of order	7
2.16 Plus features.....	7
2.17 Accessories	7
2.17.1 Threaded rod kit (Hangers)	7
2.17.2 Flexible hoses	7
2.17.3 Transformer.....	7
2.17.4 Tectite fittings.....	7
3. Product specification	8
3.1 Product description.....	8
3.2 Dimensions	8
3.3 General structure	9
3.4 Material data	9
3.5 Environmental Declarations.....	9
3.6 Pressure Class.....	9
3.7 Water quality	9
3.8 Air quality	9
3.9 Capacity test.....	9
4. Connections.....	10
4.1. Water connections	10
4.1.1 Before installation	10
4.1.2 Push-on valve.....	11
4.1.3 Compression fitting.....	11
4.1.4 Flexible hoses.....	11
4.1.5 Possible connections water cooling or heating (2-pipe, standard).....	12
4.1.6 Possible connections water cooling and heating (4-pipe, standard)	12

4.1.7 Water pipe dimensions and placement.....	12
4.1.8 Coupling & Connecting	13
4.1.9 Minimum permitted waterflowa for non-hori- zontal installation	14

5. Installation of product

5.1 Handling of product	15
5.2 Adaption to ceiling systems.....	15
5.3 General installation principles.....	15
5.4 Preparation for installation on the product.....	15
5.4.1 Mounting with adjustable pendulums.....	15
5.4.2 Mounting in chains.....	16
5.4.3 Mounting direct to concrete	16
5.4.4 Mounting in sports halls	16
5.4.5 Insstalled recessed in a suspended ceiling	17

6. Adjustment and commissioning.....

6.1 Airflow and pressure	18
6.2 Adjustment of air distribution pattern.....	18
6.3 Measuring air pressure and calculating of air flow.....	18
6.4 Water flow rate	18
6.4.1 Pre-setting of valves	18
6.4.2 Balancing strategy	18

7. Maintenance.....

8. Accessories.....

Installation instruction

Atrium / Loggia

1.1 Symbols



Hot water



Heavy Load - 2 man job - It is recommended to use a "lift" for mounting.



Cold water



Hand-pull

2. Control of delivery

2.1 Before starting

Read through the entire installation instruction before commencing installation in order to determine which parts that needs to be performed and in what order to be done.

Lindab is a supplier of complete water products, but we offer also a wide range of accessories which suit perfectly to our water products simplifying your installation work, e.g. different type of hangers, push fittings, closing valves, thermostatic valves and actuators, flexible hoses, customized regulation components, customized cabling and more. See also the separate document "[Accessories.](#)"

Lindab will also provide you with a full ventilation system, with a wide range of Lindab Safe components. See also "Air Duct Systems."

2.2 Safe operation

Beware of sharp edges, especially of the coils (beams only). Always wear thin gloves and protective clothing.

All existing safety regulations must be observed when working with Lindab water products. Check the weights of the beams or the panels with the installation instruction before carrying.

2.3 Receipt of goods

Start by checking that the delivery is complete according to the order and that everything listed on the consignment note has been delivered. Then carry out a review of the products and make sure that nothing was damaged during transportation. If you discover damage that has occurred during delivery, it must be notified immediately.

Lindab is not responsible for costs associated with the replacement of products, that have been installed in any way other than shown in these installation instructions.

2.4 Unloading of goods

The beams and panels are normally delivered packed on wooden pallets. Lift the pallets carefully with a fork lift and place them on a dry and plain surface/ground. If the beams are delivered in single boxes, wooden blocks should be placed on the ground at one-metre intervals (or a pallet), before the boxes are been placed to store. Lindabs water

products must be stored on a plane surface in a dry and well ventilated place, preferably indoors. If they have to be stored outdoors, protect them with a waterproof cover and store them protected from rain beneath a roof or other until they are fitted.

2.5 Handling / Carrying

The beam or panel must be handled with care, ensuring that it will not be scratched or bended during transportation, preparation and installation.

Always carry the beams or panels piecewise into the building. Keep the product in the package as long as you can.

Never use piping connections or edges to lift them, neither when you unpack them nor when you carry them towards the construction site.



Do not place the product directly on the floor. Use the protective corners from package or other clean means from package to place the product before installation.

Be careful if you must carry a long panel horizontally; if the panels are bended lengthwise, the profiles may be deformed and the piping could loosen from the panel. When opening the box with a knife, be careful not to damage the product.

Each beam or panel is equipped with protective film to avoid any damage during transportation and handling on building site. The film needs to be removed before commissioning the products.



Installation instruction

Atrium / Loggia

2.6 Tools

To install the beam, panel or facade unit, the following tools are required.



Knife



Gloves



Shoes with soft soles

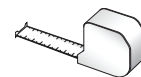

Tape measure

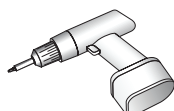

Drill machine

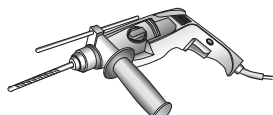

Percussion drill

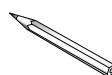

Pencil

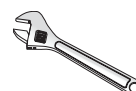

Spanner

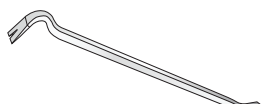

Crowbar

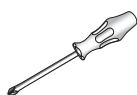

Screwdriver

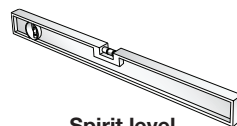

Spirit level

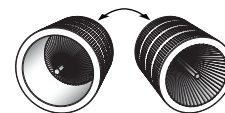

Deburring tool

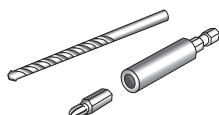

Bits and drills



Vacuum cleaner



Dust-cleaner

2.7 Installation

It is important to use the correct hangers and the recommended amount for all installation principles. Different possible installation principles are shown in the installation instruction and hangers from Lindab should be used to ensure, that they are intended for the purpose and are safe to use.

Lindab's water products can be ordered, to be adapted to a wide range of different ceiling systems, please check installation instruction to ensure best adaptation.

The Lindab water products should always be installed separately hanged up from the recessed ceiling. The weight of the product should not be covered by the ceiling system.

Use plastic folio or other to protect the product during on site construction continually to keep the products in best condition and avoid any scratches.

2.8 Where to find additional instructions or technical documentation

In the following chapters we will refer to additional technical documents or/and instructions by a certain keyword written as a link.

You can also find relevant related documents with our Lindab Quick selection tool:

1. Visit www.lindQST.com
2. Select "documentation"
3. Select product
4. Find relevant documents under "Related documents"

2.9 Cleaning after assembly / before commissioning

Please remember to remove plastic folio and other protection material before commissioning and clean the product before hand over.

Installation instruction

Atrium / Loggia

2.10 Packing, unpacking guideline

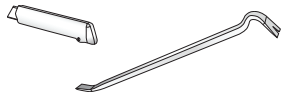

! Never use water pipe connections for lifting



Installation instruction

Atrium / Loggia

2.11 Product labelling

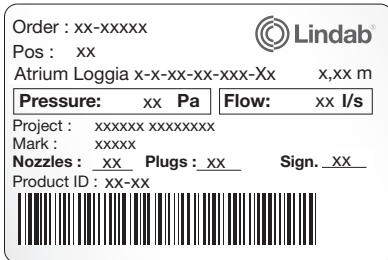

Fig. 1: **Atrium H** - Label location exterior (on insulation, above water connection).
Atrium C Label location exterior (above water connection).

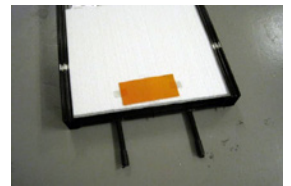

Fig. 2: **Loggia** - Label location exterior (on insulation, above water connection).



Fig. 3: **Atrium H** - Label location interior (under insulation, above water connection).



Fig. 4: **Loggia** - Label location interior (under insulation, above water connection).

2.12 Order code

Product	Atrium H	60	10	1	4.8m
Type					
Atrium H, Atrium C					
Loggia					
Width					
33 - 60 - 87 cm					
Water connection					
10 - 12 - 15 - 22 mm					
Coupling option					
1 - 2 - 13 - 14 - 23 - 24					
Length					
1.2 m - 6.0 m (in steps of 0.1 m)					

Example: Atrium-H-60-10-1-4.8m

2.13 Order code examples

Not relevant for Atrium/Loggia

2.14 Label

On the label you'll find:

- Order: Order identification number
- Pos.: Order position
- Product: Product configuration and product length
- Data: Preset static nozzle pressure [P_a] and primary airflow rate (l/s).
(not relevant for Atrium/Loggia).
- Project: Project name
- Mark: Marking noted on order
- Product ID: Product number
- Sign: To be signed when checked and commissioned on site

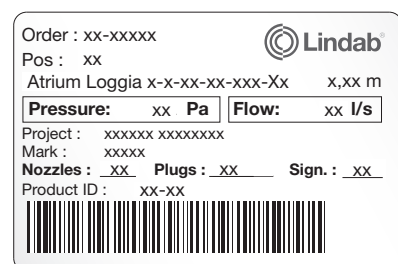

Installation instruction

Atrium / Loggia

2.15 Contents of order

Standard package/order contains:

- Beam/panel
- Accessories (separate in smaller box)

2.16 Plus features

Not relevant for Atrium/Loggia

2.17 Accessories

Here are some general accessories. For full range and order numbers, see separate [Accessories](#) document. Go to "8. Accessories" in this document to find accessories order numbers.

2.17.1 Threaded rod kit (Hangers)



M8 x4 per panel when $L_{nom} \leq 4000$ mm
M8 x6 per panel when $L_{nom} > 4000$ mm

Go to 5.4 "Preparation for installation on the product" for more details. *Order no:* See [Accessories](#).

2.17.2 Flexible hoses

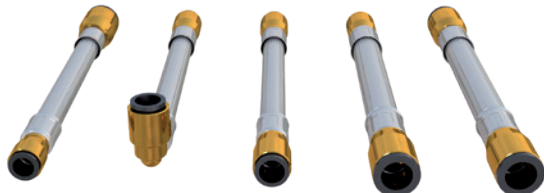

Order no: See [Accessories](#).

2.17.3 Transformer



Order no: See [Transformers](#).

2.17.4 Tectite fittings



See [Accessories](#).

Installation instruction

Atrium / Loggia

3. Product specification

3.1 Product description

The top of the Atrium H- and the Loggia panels are insulated with extruded polystyrene foam and should not be placed in direct sunshine or underneath other heating- or ignition sources. Sparks and smoke must be avoided. Keep places dry and ventilated and take precautions against static electricity.

The foamed plastic is manufactured without the addition of CFC or HCFC gas, i.e. Freons.

For full technical data sheet please contact Lindab.

Atrium-H is a heating panel. It is equipped with end-pieces and can be installed recessed into a suspended ceiling. The top of the panel is insulated with extruded polystyrene foam.

Atrium-C is a cooling panel. It is equipped with end-pieces and can be installed recessed into a suspended ceiling. The top of the Atrium-C is not insulated.

Loggia is a heating panel. It does not have end-pieces on its short sides. Loggia is therefore not designed for installation in the supporting structure of a suspended ceiling. Loggia is suited for industrial premises, for example, warehouses, showrooms, etc. The top of the panel is insulated with extruded polystyrene foam.

3.2 Dimensions

Width and height, cm



Figure 5. Atrium and Loggia are manufactured as standard in three widths, 33, 60* and 87 cm, and one height, 6 cm. Actual width dimension is -8 mm.

* The width fits a standard T support (600 mm modules).

Length, m

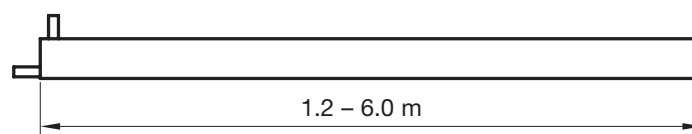

Figure 6. Atrium and Loggia are manufactured as standard in lengths from 1.2 m to 6.0 m in steps of 0.1 m. Actual length dimension is -12 mm.

Installation instruction

Atrium / Loggia

3.3 General structure

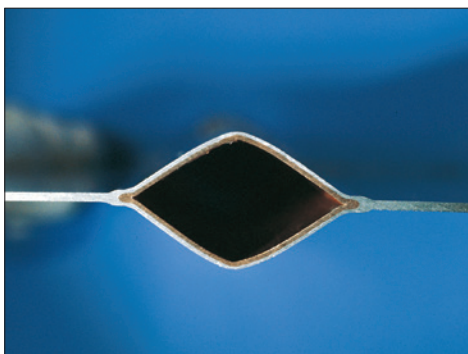

Fig. 7. Cross-section of the metallurgically bonded copper and aluminium plates and the rhomboid water duct.

The design of the panels is based on a worldpatented method of joining a copper pipe to an aluminium plate. The aluminium plate is metallurgically bonded with the copper pipe (the materials are partially fused together under very high pressure). The copper pipe has a rhomboid shape (see Fig.7).



Fig. 8: Loggia has no end-pieces



Fig. 9: Atrium is equipped with end-pieces, hiding the piping headers.

3.4 Material data

	Atrium / Loggia 33	Atrium / Loggia 60	Atrium / Loggia 87
Dry weight, [kg/m]	1.3	2.2	3.1
Water content, [l/m]	0.18	0.35	0.53
Copper pipes, quality	EN 12735-2 CU-DHP		
Pressure class	PN10		
Expansion at HW**: + 55/45°C	0.7 mm/m		
Expansion at HW**: + 80/60°C	1.2 mm/m		

Table 1. Material data.

HW** - Hot Water

3.5 Environmental Declarations

Please follow the links below:

- [Building product declaration](#)
- [Declaration of conformity](#)

3.6 Pressure Class

The waterborne products in Lindab, active chilled beams (battery products), passive chilled beams (battery and strips products), facade units (battery) and radiant panels (strips and panels) are produced according to pressure class PN 10 according to EN 1333: 2006.

This means the maximal working pressure for the products at a water temperature of 20°C must not exceed 10 bar.

3.7 Water quality

Lindab recommend water treatment and quality to be according to VDI 2035-2.

- The water preparation and maintenance for the chilled beam water circuit must be handled by a specialist.
- To prevent corrosion, the water circuit must be airtight.
- The water system must also be equipped with aerators to remove any build-up air in the system.
- The water must be oxygen free, to prevent corrosion.
- The water system must be filled with potable water that complies with the "EC directive 98/83/EC."
- The pH value of water must be between approximately 6-9 pH.
- The water velocities should not exceed 1 m/s, and should be kept as close to the nominal flow as possible to minimize noise and optimise the energy yield.
- Use in-line strainers to remove dirt particles from the water.
- If the water contains any additive inhibitor, then it must be appropriate to use with copper and solder.

3.8 Air quality

Not relevant for Atrium/Loggia

3.9 Capacity test

Atrium / Loggia panels are tested according to EN-14240: 2003, EN-14037-2: 2016 and EN-14037-5: 2016 at accredited to EN ISO/ IEC 17025 notified body by DIBt according to (EU) No. 305/2011 NB 1428, WSPlab, Stuttgart, Germany and are CE-marked.

Installation instruction

Atrium / Loggia

4. Connections

4.1. Water connections

For the control valves, a special direction of the flow must be upheld to ensure correct flow through the control valve. Please note the flow direction indicator on the valve to insure correct installation in relation to the desired flow.

When connecting a panel or a beam with the piping system either a push-on fitting or a compression coupling should be used. Lindab have tested and recommends John Guest push on fittings as well as push-on fittings from Tectite which are available as accessory. See [Accessories](#).

To avoid sound being transported over the beam, we recommend to use our flexible hoses between the piping and the beam connections. See [Accessories](#).

NB! Every control valve can create sound when it is installed directly connected to the water in- or outlet (or into the piping in close distance to the in- or outlet of the water product). To avoid unwanted sound generation we recommend to always use a Lindab control valve [LinFlow-A](#) (angled) or [LinFlow-S](#) (straight) and calculate the beam or panel with the valve in [LindQST waterborne calculator](#).

4.1.1 Before installation

- Notice! The connection pipes are internally soft-welded, therefore it is not allowed to solder the beam to the pipes. For other than Lindab fittings and valves, please consult the installation guide for the specific fitting for further details on proper installation.
- Both inlet- and return pipes are covered by a plastic or rubber protection cover, which must be removed before installation.

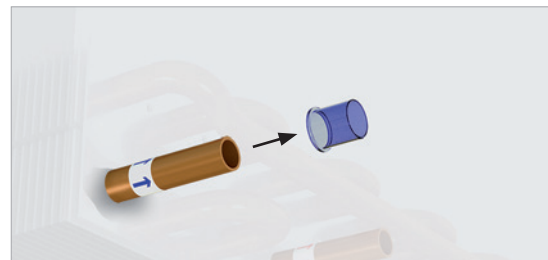

- After removing the protection cover, make sure that the pipe is intact and undamaged, especially at the pipe end, as even small dents and scratches potentially pose a risk of leakage in the system.
- Eventually deburr the pipe ends on the inside and the outside, using a deburring tool before installation.

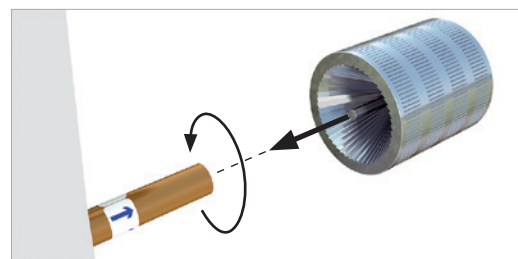
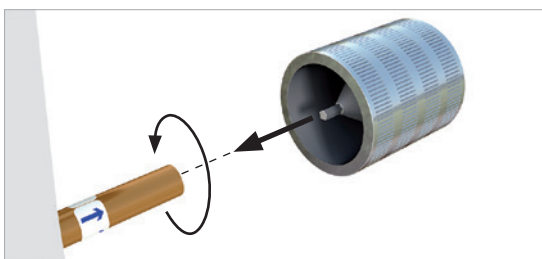
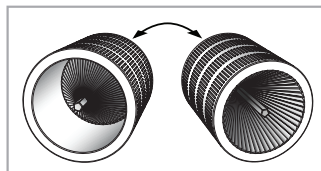

- Always remember to do a pressure test after assembly of the pipe work.

Installation instruction

Atrium / Loggia

4.1.2 Push-on valve

- Mount a push-on valve to the pipe. Make sure the valve has the correct flow direction (see indication arrow on the valve) and that you have the correct valve, when integrated valve has been chosen (see indication on valve or follow cabling to Regula Connect card). Cooper inserts aren't required!
- Please refer to the suppliers manual.

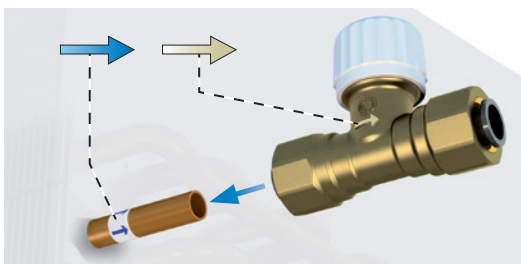

4.1.3 Compression fitting

- While mounting a compression fitting, the pipe will be exposed to a big amount of force, creating a risk of crushing the pipe. To ensure that the pipe won't be crushed when mounting the compression fitting, a copper insert must be inserted into the pipe (always part of the delivery).
- The copper insert should be placed inside the pipe on the beam. Always support the copper pipe coil when inserting the copper insert into position.
- Mount a compression coupling and/or a valve to the pipe. Don't stress the nut too much, since this may crush the pipe.
- Please refer to the suppliers manual.

4.1.4 Flexible hoses

- Our flexible hoses with straight ends can be used with both push-on and compression fitting.
- We recommend to use our flexible hoses with push-on fittings, for easier and faster mounting.
- For the connection to an enclosed valve with integrated push on coupling a flexible hose with straight end (male) or with push on (female) and a short copper pipe can be used.
- Please refer to the suppliers manual.

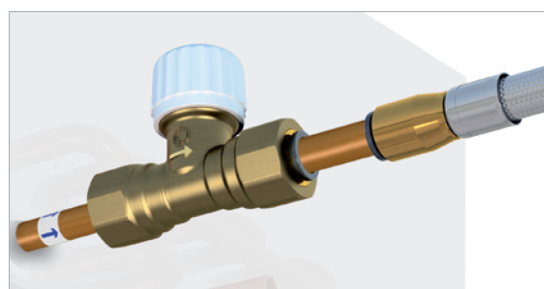
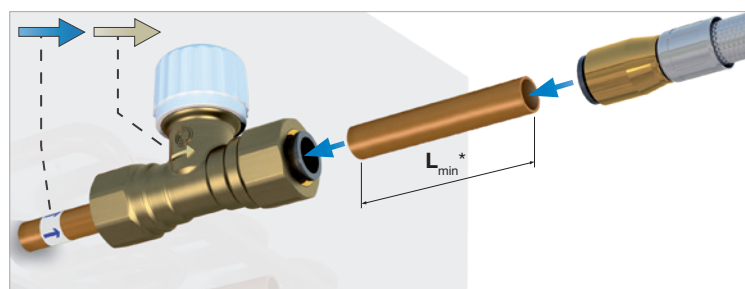
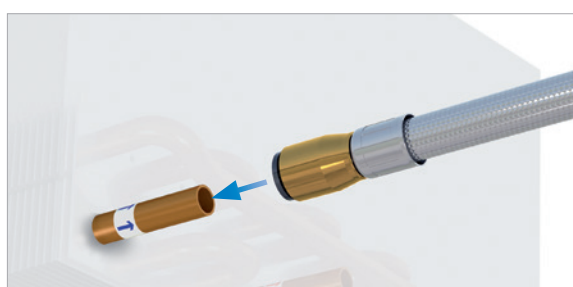

* $L_{min} = 70 \text{ mm}$ (to ensure you can open the couplings again).

Lindab flexible hoses are available with straight end (male) for direct connection to Lindab valves also.

Installation instruction

Atrium / Loggia

4.1.5 Possible connections water cooling or heating (2-pipe, standard)

All the Atrium / Loggia radiant panels are available with “2-pipe water connection” with one water circuit only.

All water pipe connections are $\varnothing = 10$ mm.

Connect water with push-on or compression couplings or similar. Use the support sleeves. Do not solder! (see chapter 4).

4.1.6 Possible connections water cooling and heating (4-pipe, standard)

Not relevant for Atrium/Loggia

4.1.7 Water pipe dimensions and placement.

Dimensions, mm

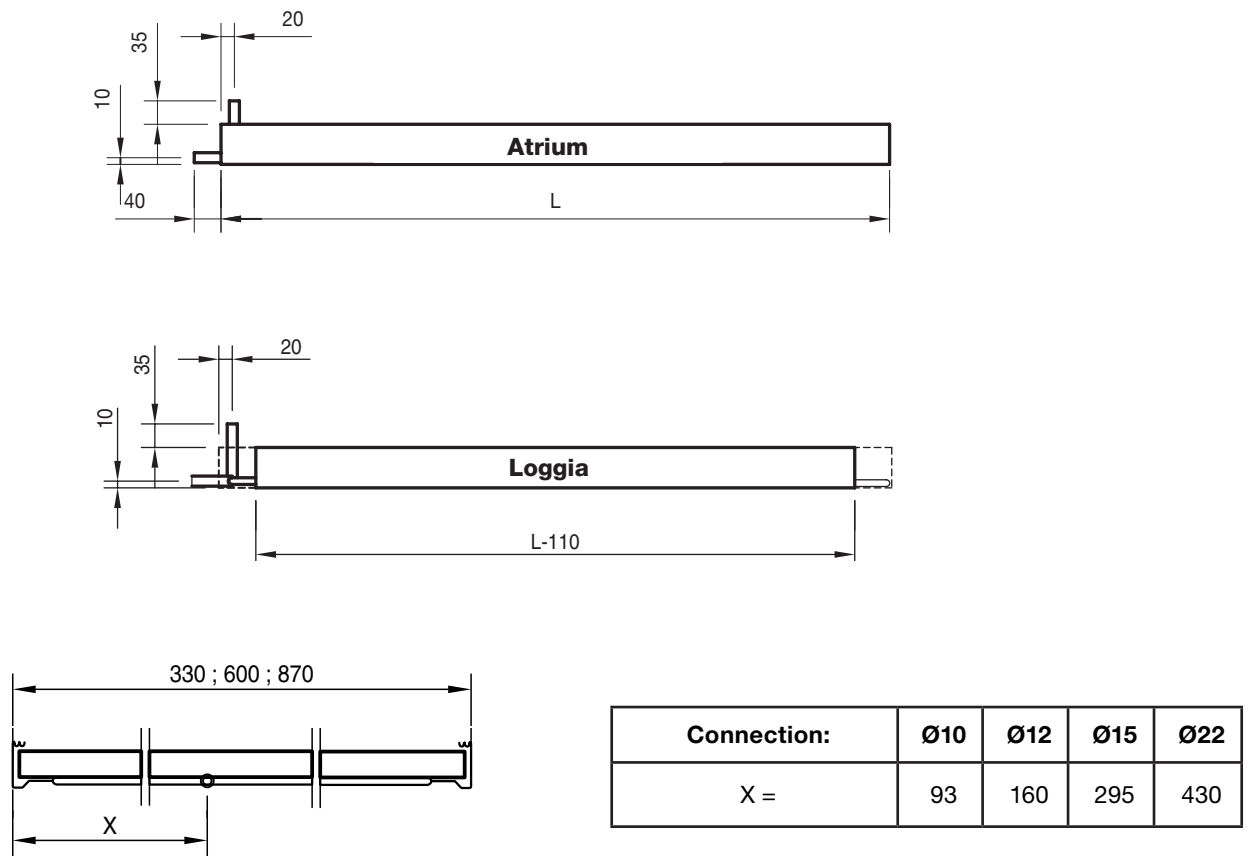

Figure 10. Atrium and Loggia dimension, water connection and connection.

Installation instruction

Atrium / Loggia

4.1.8 Coupling & connection

Atrium and Loggia are supplied in lengths of up to 6 metres. When the required length is longer than 6 metres, panels can be coupled in series.

Width 33		Width 60		Width 87	
Coupling options	Connection (mm)	Coupling options	Connection (mm)	Coupling options	Connection (mm)
1	10	1	10, 12	1	10, 15
2	10	2	10, 12	2	10, 15
Coupling options	Connection (mm)	Coupling options	Connection (mm)	Coupling options	Connection (mm)
13	10	13	12	13	15
14	10	14	12	14	15
24	10	24	12	24	15
Coupling options	Connection (mm)	Coupling options	Connection (mm)	Coupling options	Connection (mm)
13	12	13	15	13	22
14	12	14	15	14	22
24	12	24	15	24	22

Table 2. Atrium / Loggia, coupling and connection options.

NB! Connections should be made with compression couplings, press couplings or Tectite.

When applying the Atrium beam into a recessed ceiling, coupling option 2 or 24 should always be used to clear the pipes from the supporting frames of the ceiling (T-bar).

Installation instruction

Atrium / Loggia

			
<p>1 (1 connected)</p>	<p>13 (double circuit)</p>	<p>1+13 (1 connected + double circuit)</p>	<p>13+13 (straight through)</p>
<p>The supply and return for this model are located in the same end-piece.</p> <p>This coupling is only available with one pipe dimension per panel width.</p> <p>Width 33: Ø10 mm Width 60: Ø10 + Ø12 mm Width 87: Ø10 + Ø15 mm</p>	<p>This model has the supply in one end-piece and the return in the other one.</p> <p>This coupling is only available with one pipe dimension per panel width.</p> <p>Width 33: Ø10 mm Width 60: Ø12 mm Width 87: Ø15 mm</p>	<p>This model is a combination of 1 connected panel + 1 double circuit.</p> <p>This coupling is available with only one pipe dimension per panel width.</p> <p>Width 33: Ø10 mm Width 60: Ø12 mm Width 87: Ø15 mm</p>	<p>This model has the supply in one end-piece and the return in the other one.</p> <p>This coupling is only available with one pipe dimension per panel width.</p> <p>Width 33: Ø12 mm Width 60: Ø15 mm Width 87: Ø22 mm</p>

Table 3. Atrium and Loggia coupling & connection.

4.1.9 Minimum permitted waterflows for non-horizontal installation

Minimum permitted flow, non-horizontal mounting q_{wmin} (l/s)	Width 33		Width 60		Width 87	
	Cooling	Heating	Cooling	Heating	Cooling	Heating
dim Ø10	0.013	0.015	0.013	0.015	0.013	0.015
dim Ø12	0.026	0.030	0.026	0.030	-	-
dim Ø15	-	-	0.052	0.060	0.039	0.045
dim Ø22	-	-	-	-	0.078	0.090

Table 4. Atrium and Loggia, recommended minimal water flow rates q_{wmin} .

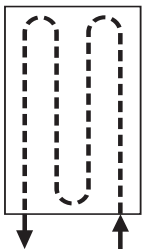
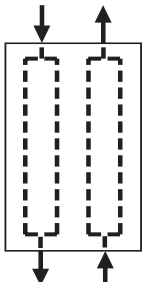
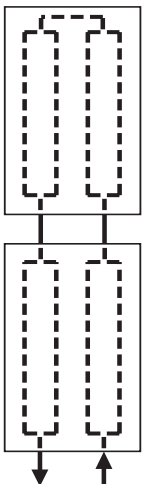
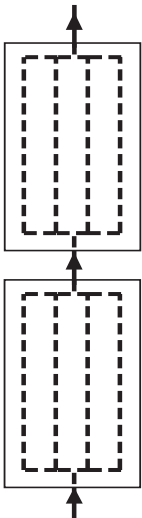
NB! If the panel is not mounted in a horizontal plane, the recommended minimal water flow rates q_{wmin} should be maintained, to avoid air build up. No separate air release valve is then required for the panel.

Installation instruction

Atrium / Loggia

5. Installation of product

5.1 Handling of product

For the handling of the product please refer to 2.5.

5.2 Adaption to ceiling systems

Not relevant for Atrium/Loggia

5.3 General installation principles

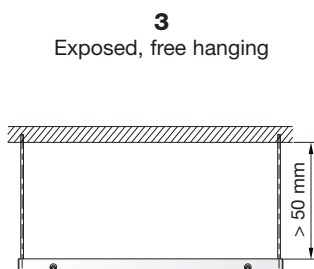
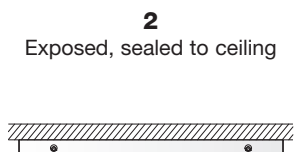
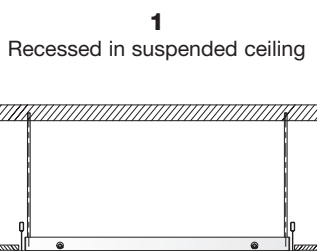

5.4 Preparation for installation on the product

1.- Measure and drill into the ceiling for the strips/panels brackets. 4 pieces for lengths up to 4.0 m, 6 pieces for longer units.



5.4.1 Mounting with adjustable pendulums

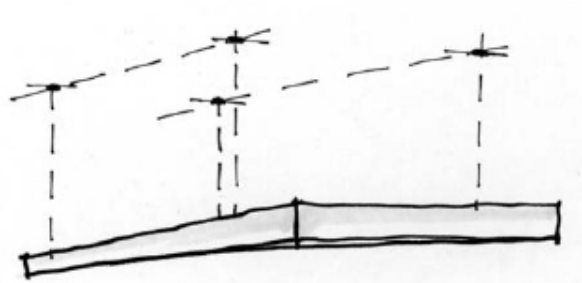

- 2.- Screw up the brackets into the ceiling
- 3.- Hang up the pendulums into these brackets.
- 4.- Hang up the strips/panel with the Atrium panel hook into the edge of the panel and connect the pendulums into these.

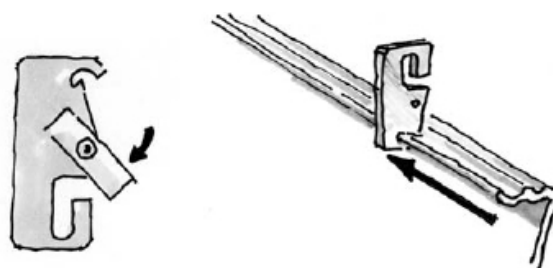

- 5.- Adjust the length of the pendulums. Also adjust after the false ceiling height if it's mounted into this.

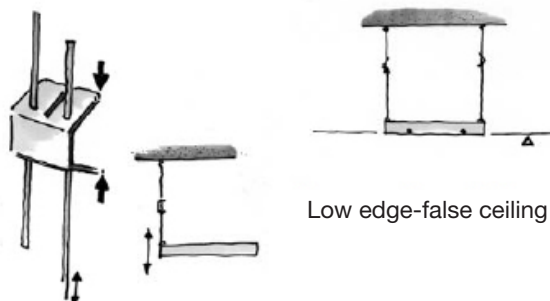

Installation instruction

Atrium / Loggia

5.4.2 Mounting in chains

1.- Measure and drill into the ceiling for the strips/panels brackets. 4 pieces for lengths up to 4.0 m, 6 pieces for longer units. Observe that the chains must be angled inwards so the angle brackets will be secured.

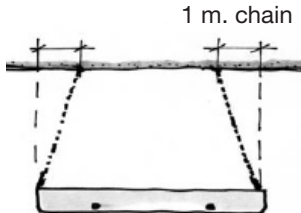

2.- Screw up the brackets for the chains into the ceiling.

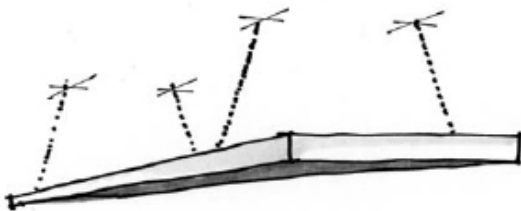

3.- Hang up the strips/panel with the Atrium panel hook into the edge of the panel.

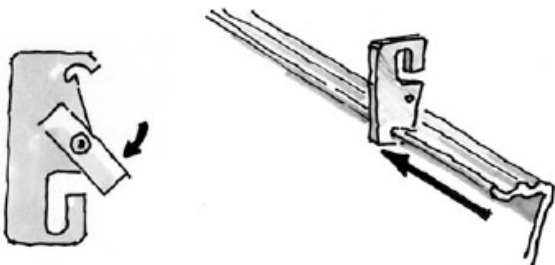

4.- Adjust the length of the chains as you see of the drawing.



5.4.3 Mounting direct to concrete

1.- Measure and drill into the concrete for Atrium mounting brackets. Use 6 pieces with lengths above 4.0 m.

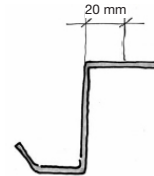

2.- Screw up the strips/panel against the concrete.

5.4.4 Mounting in sports halls

Special Atrium hangers for sports halls are available to enable both direct to concrete and recessed (exposed) installation.

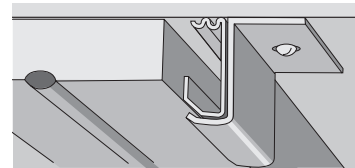

1.- Measure and drill into the concrete for Atrium mounting brackets. Use 6 pieces with lengths above 4.0 m.

2.- Screw up the strips/panel against the concrete.

Installation instruction

Atrium / Loggia

5.4.5 Installed recessed in a suspended ceiling (Atrium only!)

It is best if the ceiling installer mount some head profiles before the panels will be mounted. This is to make it easier for the panel installer. If the head profiles already are mounted it is very important that you use a line/wire to have the beams in the right position.

1. Fix the head profiles against the panel with pop rivets or screws.



2. Mount the secondary profiles around the panel. Cut off the steering pins and fix with pop rivets.

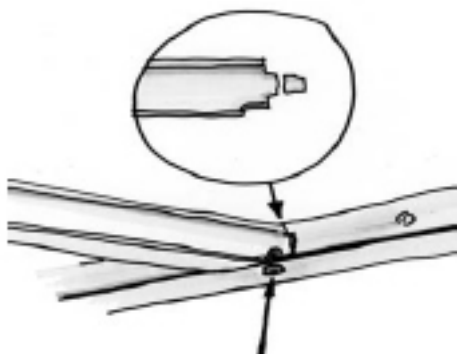

3. One of ceiling plates and one secondary profile must be cut out, to make room for pipe connections (only with horizontal connection pipes).

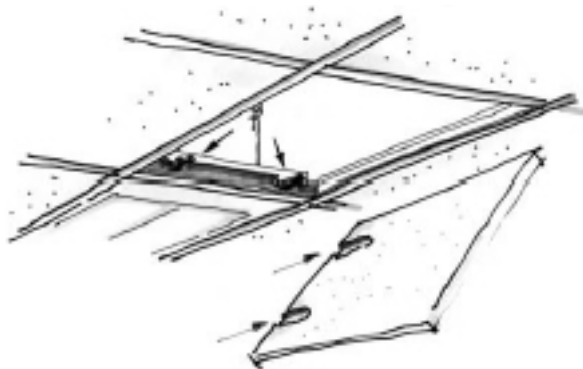

Mounting wire spring

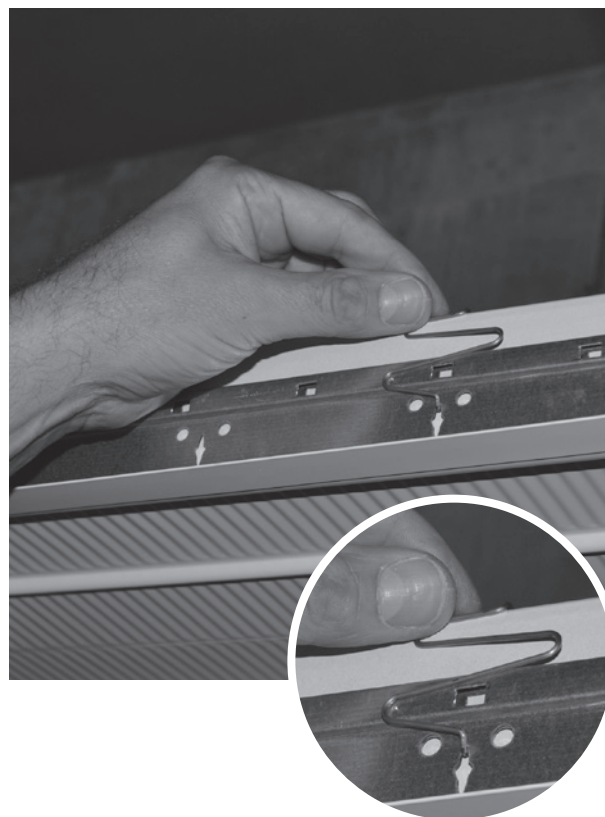

- 1.- Attach the ceiling clip into the ceiling grid.
- 2.- Press it over the top of the panel.
- 3.- Secure that the ceiling clip is attached between the ceiling grid and the heating panel.

Installation instruction

Atrium / Loggia

6. Adjustment and commissioning

6.1 Airflow and pressure

Not relevant for Atrium/Loggia

6.2 Adjustment of air distribution pattern

Not relevant for Atrium/Loggia

6.3 Measuring air pressure and calculating of air flow

Not relevant for Atrium/Loggia

6.4 Water flow rate

6.1.4 Pre-setting of valves

All the control valves are delivered not set. The presetting has to be done on site.

For the presetting of valves, please see [LinFlow-A](#) (Angled) and [LinFlow-S](#) (Straight) water valves documentation.

6.4.2 Balancing strategy

Lindab recommends always balancing the water system to guarantee thermal comfort in all areas, to avoid noise nuisance problems and to save energy. A hydraulic balance is obvious to ensure that all the beams (panels or facade units) in the system will always be supplied with their required (planned) water flow rates.

Lindab refers to the proportional method, where all beams (panels or facade units) are balanced to the same proportion of the requested water flow rate.

7. Maintenance

The interval of cleaning depends on the indoor environment where the panel is placed.

Under optimal conditions the panels only need cleaning every 5 years.

Cleaning instructions:

- Only use lukewarm water and a mild detergent.
- When cleaning from above, the ceiling plate next to the panel must be removed.
- then it will be possible to clean the panel from above.

8. Accessories

Ask Lindab for the accessories mentioned in this document. Additional accessories (or additional dimensions) are available on request.

Check also Lindab's [Accessories](#) document.

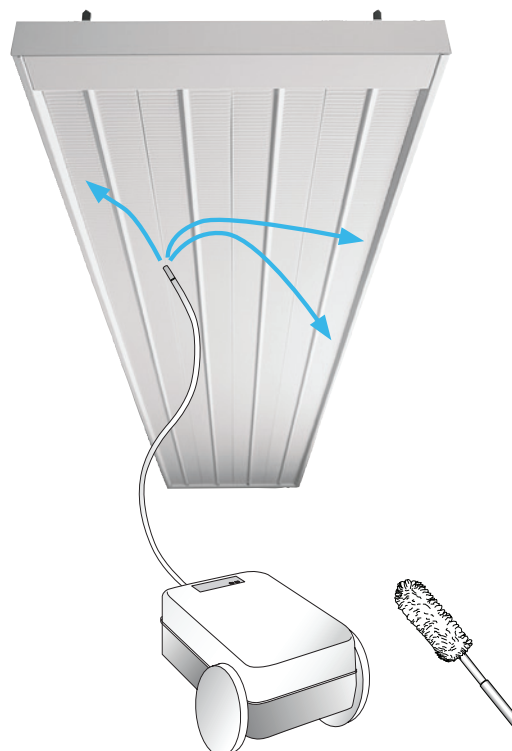



Most of us spend the majority of our time indoors. Indoor climate is crucial to how we feel, how productive we are and if we stay healthy.

We at Lindab have therefore made it our most important objective to contribute to an indoor climate that improves people's lives. We do this by developing energy-efficient ventilation solutions and durable building products. We also aim to contribute to a better climate for our planet by working in a way that is sustainable for both people and the environment.

[Lindab](#) | For a better climate