



Lindab UltraLink® Monitor FTMU

Technical information



UltraLink[®] Monitor

FTMU

Introduction

UltraLink FTCU is a highly accurate flow controller. It measures the flow with ultra sound and can be calculated and compensated to a very high accuracy within the whole flow range. The method is very stable over time due to its design, which minimizes the contamination of the flow sensors.

UltraLink FTMU makes it possible to measure low airflows while maintaining measurement accuracy. This offers great advantages for the user in terms of comfort and energy savings.

Content

Introduction	2
Overview	4
Application	4
Design	4
Display unit.....	4
Mounting	5
Planning.....	6
Table of mounting distance to disturbance	6
Electrical installation	8
Before starting:.....	8
Option A: Connect to premounted cable.....	9
Option B: Circuit board screw terminals.....	9
Commissioning	12
Display.....	12
Parameter structure	12
ID-numbers	12
Correcting flow measurement for installation close to disturbance	13
Status light	13
PIN code.....	13
Maintenance.....	13
Firmware update	14
How to upgrade your firmware	14
Configuration menu structure	14
Digital communication settings.....	15
Analog communication settings	15

UltraLink® Monitor

FTMU

- Analog out settings via Modbus 15
- Troubleshooting 16
 - If digital communication fails, verify the following before contacting support .. 16
 - Error code..... 16
 - Problems accessing UltraLink via Bluetooth..... 16
 - If analog signals fails, make sure to doublecheck the following 16
 - Error codes..... 16
- Technical data 17
 - Technical data table 17
 - Airflows..... 17
- Appendix A – Modbus register 18

UltraLink[®] Monitor

FTMU

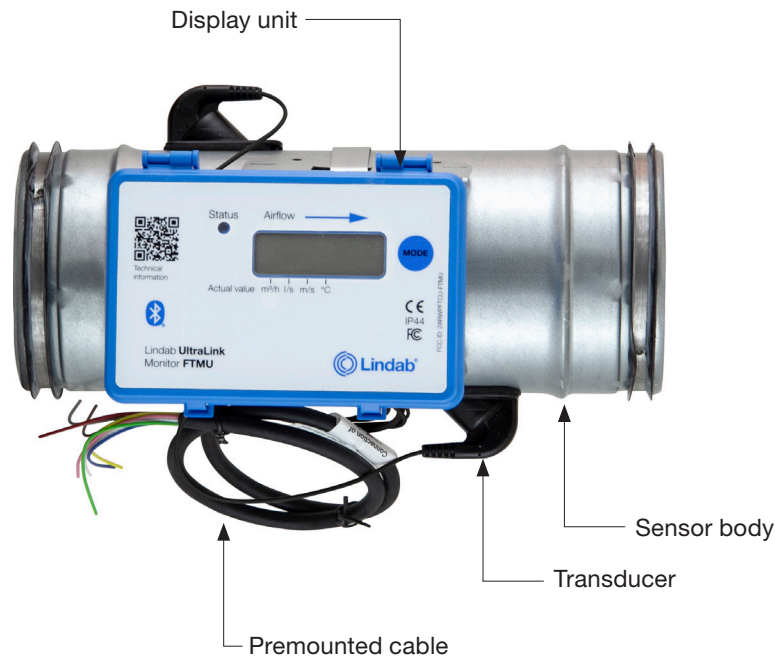

Overview

Application

The FTMU is suitable for measuring air flow and temperature. Communication is established via analog or digital signal using Modbus.

Design

The FTMU consists of a sensor body with Lindab Safe gaskets.

Two transducers are mounted on the sensor body and connected to a display unit. The display unit is mounted on top of a shelf on the sensor body.

Note! The transducers are placed at a fixed distance to each other and they shall never be removed and not used as handles when rotating the sensor body.



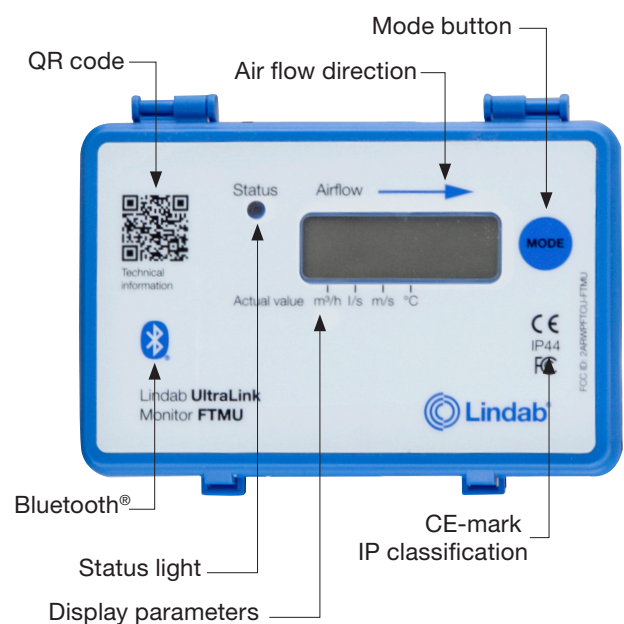

Display unit



UltraLink[®] Monitor

FTMU

Mounting

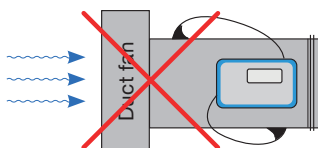
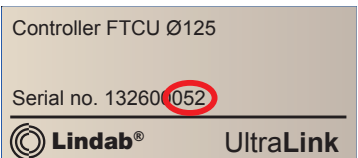
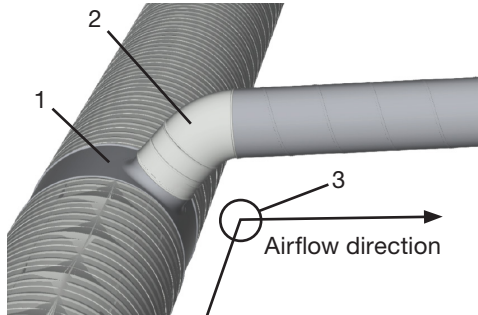
<p>Please note:</p> <ul style="list-style-type: none"> • The transducers must never be removed! • Do not use the transducers as handles when you mount the FTMU since this may cause damage! 	 <p>Transducers</p>
<ul style="list-style-type: none"> • Make sure the airflow arrow is pointing in the direction of the airflow. 	 <p>Airflow direction arrow</p>
<ul style="list-style-type: none"> • Rotate the sensor body to the correct position according to the chapter "Planning" on page 6. 	
<ul style="list-style-type: none"> • Position the display so it is visible from a suitable direction. By loosening the screw of the steel strip, the display unit can be rotated. 	
<ul style="list-style-type: none"> • Mount the FTMU into the air duct system according to the mounting instructions for Lindab Safe. 	
<ul style="list-style-type: none"> • Never use a FTMU on the outlet side of a duct fan. (Place it on the inlet side or in worst case use a flow conditioner if it must be placed on the outlet side.) 	
<ul style="list-style-type: none"> • Note the ID-number of the FTMU. The ID is the three last numbers of the serial number and can be found: <ul style="list-style-type: none"> - on the label of the box it was delivered in - on the label on the FTMU itself - in the display after pressing the "MODE" button - in the App when the product is turned on 	
<ul style="list-style-type: none"> • To avoid issues with measurement accuracy due to air turbulence: <p>Make sure you never install a measurement unit after (in airflow direction) two disturbance fittings (referring to number 1 and 2) where those two fittings are installed in two different levels and the airflow also turns in cross direction. (Referring to number 3)</p> <p>Not following these rules the measurement might not be accurate due to air turbulence.</p> <p>Where non-optimal installation situations appear, or several successive disturbance faults may exist, please contact Lindab sales for consulting.</p> 	

UltraLink[®] Monitor

FTMU

Planning

The accuracy of the measurement is dependent upon mainly two things;

- distance to disturbance (the longer distance to disturbance, the higher the measurement accuracy will be)
- and the positioning of the transducers (FTMU is to be mounted with the first transducer (*) placed at the inner radius of a fitting)

Below you can see the impact of various disturbances and placements of the transducers.

The FTMU can be placed at the distance of two duct diameter ($\varnothing d$) from the disturbance to achieve the specified uncertainty in the table below. In some cases you can mount the FTMU directly onto a fitting and still have the same measurement accuracy. In those cases you need to make corrections inside OneLink app. In the table below you can see what scenarios are applicable.

Other obstructions such as axial fans, silencer baffels or cleaning hatches etc. are not allowed before the UltraLink (in the direction of the airflow). If a cleaning hatch is required, it must be placed after the UltraLink (in the direction of the airflow). All these cause turbulences, which will result in airflow measurement errors.

Table of mounting distance to disturbance						
Disturbance	* Placement of first flow sensor		Measurement uncertainty \pm % or X l/s depending wich is the greatest of percentage or the absolute value for the specific product size, see "Technical data" on page 17			Mounting directly onto fitting without distance possible
			a			
			2-4· $\varnothing d$	>4-5· $\varnothing d$	>5· $\varnothing d$	
Bend		Inner radius (Best position)	5	5	5	Yes
Bend		Outer radius (Not recommended)	20	10	5	-
Bend		Side	10	5	5	-

UltraLink[®] Monitor

FTMU

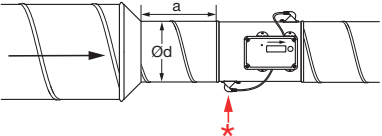
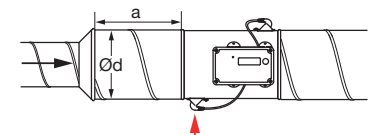
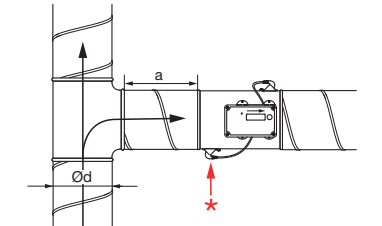
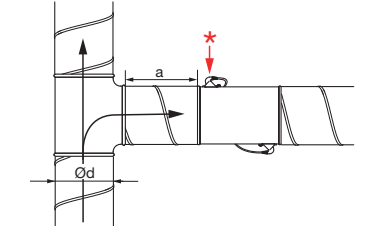
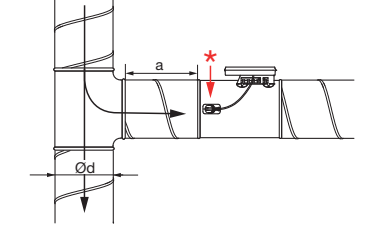
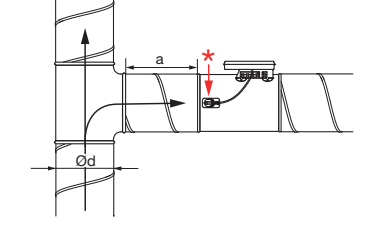
Table of mounting distance to disturbance						
Disturbance	* Placement of first flow sensor		Measurement uncertainty ± % or X l/s depending which is the greatest of percentage or the absolute value for the specific product size, see "Technical data" on page 17			Mounting directly onto fitting without distance possible
			a			
			2-4·Ød	>4-5·Ød	>5·Ød	
Reducer		Duct diameter decrease	5	5	5	Yes
Reducer		Duct diameter increase	10	5	5	Yes
T-piece		Inner radius (Best position)	10	5	5	-
T-piece		Outer radius (Not recommended)	20	10	5	-
T-piece		Side	10	5	5	-
						

UltraLink[®] Monitor

FTMU

Electrical installation

Before starting:

- You must under no circumstances make any holes or connect anything with screws to the body of the FTMU.
- The shelf, FTES, can be used for mounting equipment such as an electrical junction box or a Regula Combi.
- Never remove the blue electronics box.
- Never remove the transducers.



For cable connections there is two options, use the premounted cable or connect directly in the PCB.

Option A:

Use the premounted cable >>

- Connect power and communication cables to the premounted cable.
- Check the label on cable for reference to cable colours.
- It is important that the cable is as short as possible for optimal Modbus communication.



Option B:

Connect directly on PCB >>

- To access the terminals on the circuit board, remove the lid by pushing the two heels on the side of the blue box.
- To be able to connect cords to the terminal board the rubber cable grommet on the backside of the display unit must be punctured, preferably using an awl or something pointy to ensure tightness to the environment. Do not remove the blue box to do this!
- When the cables have been connected they must be strain relieved. The cables can be attached to the shelf by using cable ties that are attached around cut outs in the shelf.

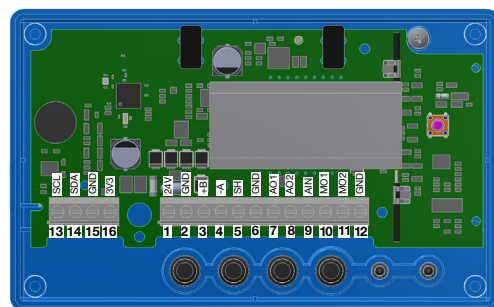

UltraLink[®] Monitor

FTMU

Option A: Connect to premounted cable

Connect the premounted cable in a junction box near the FTMU. Connect power and signal cables in the junction box according to the color scheme on the label on the premounted cable, see picture to the right.

When connecting Modbus signal wires, the length of the premounted cable needs to be as short as possible, since these have a negative effect on signal quality.

In this case, place junction box as close to the FTMU as possible, then cut the premounted where it is as short as possible for installation.

Connection of UltraLink

Note! All cables that are not connected must be insulated.

24V	Red
GND	White
+B	Yellow
-A	Brown
GND	Grey
AO1	Green
AO2	Blue
AIN	Pink

Option B: Circuit board screw terminals

Connections are made in the terminal board which can be accessed when the lid of the display unit is removed. In the back of the lid there is a picture with a list of the terminals.

1. **24V**, power supply (AC G, DC +) *
2. **GND**, power supply (AC G0, DC -) *
3. **+B**, connection for Modbus via RS485
4. **-A**, connection for Modbus via RS485
5. **SH**, shield
6. **GND**, ground (system neutral)
7. **AO1**, analog output
8. **AO2**, analog output
9. **AIN**, (not used in this version)
10. **MO1**, (not used in this version)
11. **MO2**, (not used in this version)
12. **GND**, ground (system neutral)
13. **SCL**, not used
14. **SDA**, not used
15. **GND**, ground (system neutral)
16. **3V3**, not used (in case of biasing)

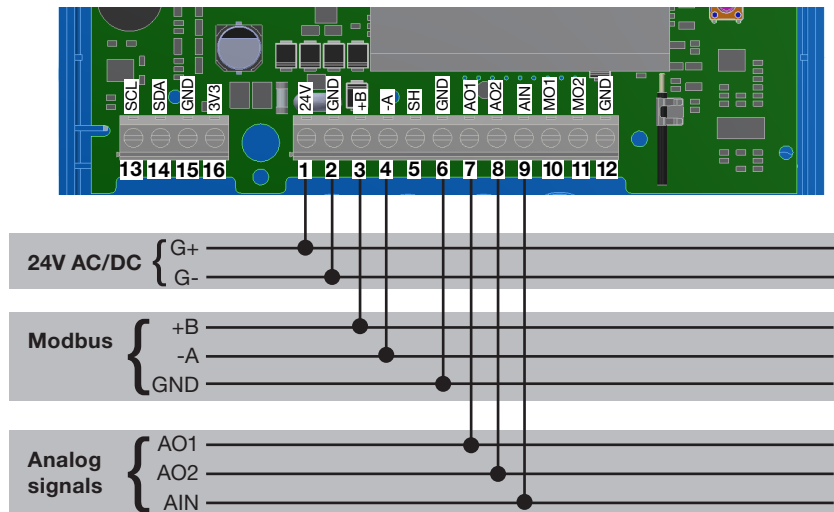

*) When using AC terminal 1 (G) should have system potential and terminal 2 (G0) should be system neutral.

Recommendations for wiring

Function	Cable type
24 V Supply	2-wire, thickness depending on length and load, max. 1,5 mm ²
RS485 Modbus communication	2-wire shielded twisted pair, min. 0,1 mm ² (LIYCY cable)

Using other cables for Modbus signals may result in communication problems.

Analog connection

When connecting the FTMU using analog signals, it is important to connect the analog out signals on the FTMU (AO1, AO2) to the analog in terminals on the RTU and the analog in signal (AIN) is connected to the analog out terminal on the RTU. Also make sure to connect the cables to the same analog ground.

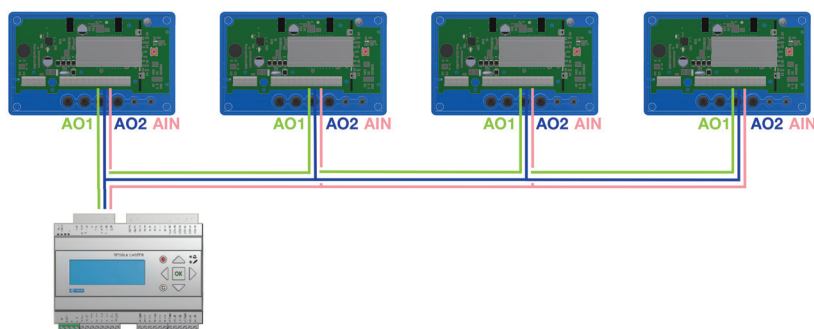

Digital connection (Modbus)

Connect A on the RTU to -A on the display unit and B to +B. When connecting more than one FTMU in series it is important to keep connecting -A to -A and +B to +B since crossing them will stop Modbus from working. It is recommended to use RS485 cables with twisted pairs and shield, do not supply power in the same cable unless the cable is produced for that purpose. When connecting signal ground, attach it to "GND" on the terminal to the right of the terminal for shield (SH) on the PCB. Then attach it to the corresponding terminal in the RTU.

Connecting shield

The shield in the RS485 cable should be connected to ground at the transformer and then continuously connect to "SH" on all the UltraLinks that are powered from that transformer. If more than one transformer is used on the bus, the shield is broken at each transformer so "SH" on every product only has connection to ground at the transformer from which its power is supplied.

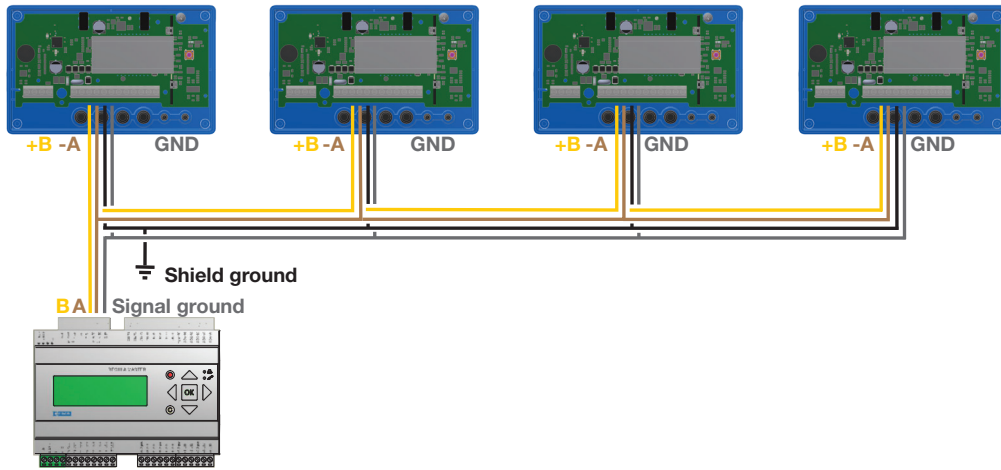

Biasing

The master on the bus must have biasing on -A and +B. This is more or less standard on BMS-controllers, but if communication should be established with a conventional computer using a RS485-USB converter, then it is important to make sure that the converter has a bias circuit. If communication fails and you are uncertain about existence of biasing,

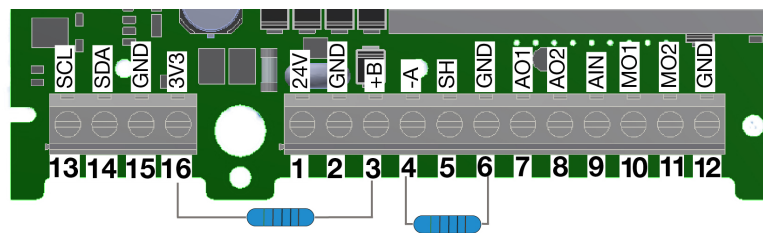

you can add biasing resistors in the screw terminal on one of the UltraLinks to see if this is the cause of the communication failure. Use 500 - 1000 Ω resistors and connect one resistor from -A to GND and one from +B to the 3V3 terminal. It is also recommended to add a 120 Ω termination resistor between -A and +B on the last UltraLink on the bus to avoid signal reflections.

Repeater

If the bus is longer than 300 meters or if there are more than 30 devices, the system might need an RS485 repeater (FDS-R, see picture to the right) to be able to communicate in an efficient way.



Power supply

Transformer sizing

The needed size of 24 V AC transformer(s) can be defined by adding up the dimensioning power consumption [VA] of all the components. The transformer power must exceed this. Use only safety isolating transformers. Calculation of the current demand I:

$I = (P_1 + P_2 + \dots + P_n) / U$ [A] **where:** P_n is the dimensioned power consumption for each component [VA] U is the voltage (24) [V].

If the current demand I exceeds 6 A (which corresponds to approximately 150 VA for a 24 V AC transformer), it is necessary to use more transformers to prevent overheating.

Supply cable sizing

The wire size of the supply cable can be determined by calculating the resistance per meter R. The calculation presupposes that a voltage drop of e.g. 2 V is accepted in the supply cable:

$R(\text{per m}) = U_{\text{drop}} / (I * L)$ [Ω/m] **where:** U_{drop} is the accepted voltage drop (2 V) in the cable [V] I is the current [A]

L is the longest distance of supply cables from transformer to a component [m]

Wire cross section area as a function of resistance per m for copper wire

Example:

$U_{\text{drop}} = 2 \text{ V}, I = 4 \text{ A}, L = 20 \text{ m}$

$R(\text{per m}) = 2\text{V} / (4\text{A} \times 20 \text{ m}) = 0,025 \Omega/\text{m}$

In the diagram a Wire cross section Area of 0,7 mm² can be read.

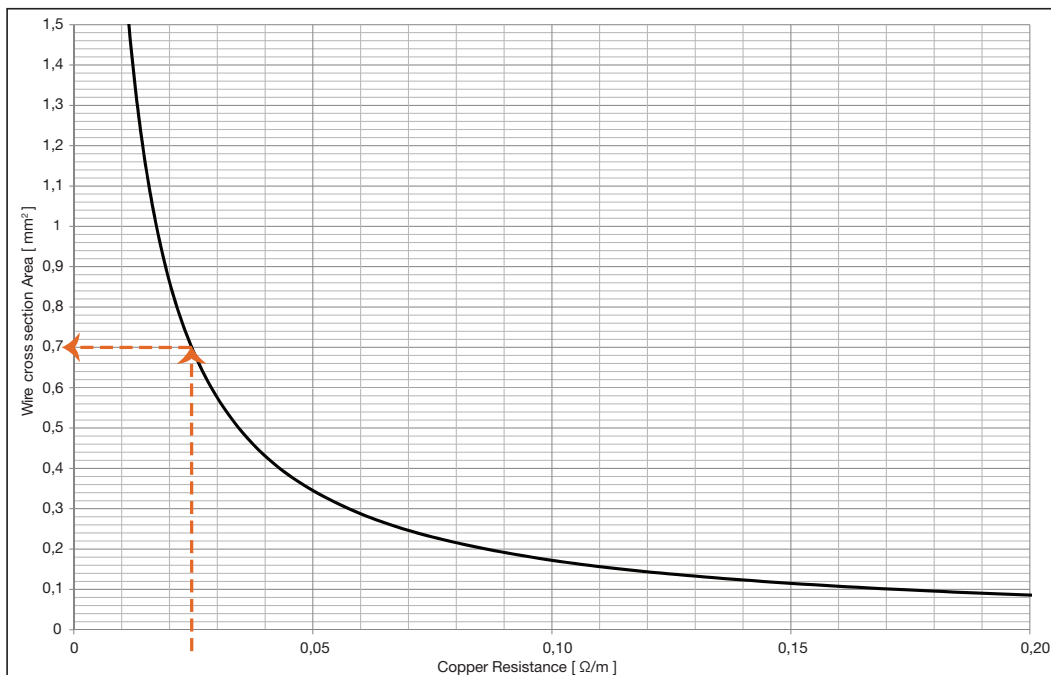

Power consumption

The power consumption for dimensioning supply cables for an UltraLink[®] FTMU is 0,5 VA.

It is not recommended to use a transformer with a higher capacity than 150 VA.

UltraLink® Monitor

FTMU

Commissioning

Commissioning of the UltraLink is done via Lindab OneLink app. Download the app to your phone by scanning or clicking on the QR code to the right.

1. Scan for devices
2. Select device and log in to it (Default PIN: 1111)
3. Adjust your settings to the UltraLink
4. If device is mounted close to disturbance, make sure you do correction settings inside the app to compensate the measurement uncertainty. See ["Correcting flow measurement for installation close to disturbance" on page 13.](#)
5. Change device PIN code. See ["Pin-code" on page 14.](#)

Download app



Display

The display can show useful information both with the diode flashing in green (status light) and with parameters in the LCD. If the product is equipped with Bluetooth, then the diode will also flash in blue every three seconds. If a device has been connected to the UltraLink via Bluetooth, then the diode will flash in blue every other second.

By short pressing the mode button you can change the displayed parameter. If the button is pressed for more than 5 seconds (long press) then the configuration menu will be visible. The arrow at the bottom of the display indicates the current parameter type and unit.



For a detailed description on configuring the UltraLink using the mode button on the display, see ["Configuration menu structure" on page 14](#)

Parameter structure

The information menu is visible in the display as soon as the device is powered and by default the air flow in m³/h is shown. You can toggle between the different parameters in the menu by short pressing the Mode button. The arrows at the bottom of the menu indicates the air flow reading, temperature and also what unit the current value has (if any). The following list of parameters are available;

- Airflow (m³/h)
- Airflow (l/s)
- Air velocity (m/s)
- Temperature (°C)
- FTMU ID number

ID-numbers

The FTMU is given an ID-number between 1 to 239 during production. The given ID-number can be seen on the label on the outside of the box the FTMU is delivered in, the ID-number is the same as the three last digits in the serial number.

If two or more Modbus devices have the same ID-number it is necessary to apply changes so that each of them get an unique ID-number to allow communication.

To change the Modbus ID register of an UltraLink® all other devices with the same ID must be disconnected. It is more efficient to change the ID in the display under "Con.Set" (see table below) or with the OneLink app. The register for Modbus ID is a holding register with address 4x001.

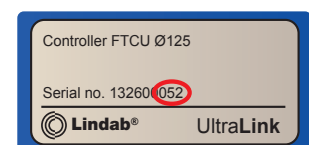

UltraLink[®] Monitor

FTMU

Correcting flow measurement for installation close to disturbance

If it is required to install an UltraLink close to a disturbance, the correction is done in OneLink app.

1. Go to OneLink and connect to the UltraLink you wish to add corrections to.
2. Go to "Configuration" > "Device settings"
3. Click on "Disturbance settings"
4. Fill in what type of disturbance is installed before the UltraLink (airflow direction) and the distance between the UltraLink and the disturbance referring to.

The function is now activated and the app corrects the flow according to the inputs made.

Status light

● The green status light indicates:

Mode		Function
No light		FTMU is turned off
Flashing light every 1 second	● ● ●	A problem has occurred, error code will be visible in display
Constant light	●	FTMU is turned on and functioning as normal

● The Blue status light indicates:

Mode		Function
No light		Bluetooth is turned off or the FTMU is not equipped with it.
Flashing light every 3 second	● ● ● ● ●	Bluetooth is on stand by and is ready to connect to mobile device.
Flashing light every 1 second	● ● ●	A mobile device has been connected to the FTMU.

PIN code

UltraLink with Bluetooth must be protected against unauthorized access by PIN-code, which has to be stated before changes to the settings can be made. It is important to choose and change the code that the product is delivered with (1111), to ensure that no unauthorized changes are made. The Bluetooth radio can be disabled by setting register 4×007 to 0.

The code can be changed via:

- "OneLink" application
- using the configuration menu in the display, see page 15 for instructions.

Maintenance

The FTMU does not normally require any maintenance. The visible parts of the device can be wiped with a damp cloth.

UltraLink® Monitor

FTMU

Firmware update

By regularly searching for and carrying out firmware upgrades, you ensure optimal performance of your UltraLink.

How to upgrade your firmware

6. Open OneLink app and log in to UltraLink
7. Go to “Configuration” > “Device info”
8. Click on “Firmware update”

Configuration menu structure

You can also do all below settings directly in the OneLink app.

The configuration menu is activated by long pressing the button (5 sec). After long pressing the button a new menu will appear with three different options;

- Con.Set (Connection settings)
- Cancel (Cancel and return to information menu)

Under Con.Set (connection settings) you can find the following options (toggle with short press, select with long press);

Menu tag	Description	Options	Description
• Pr.	Protocol	Pr.PAS Pr.Mod	Pascal protocol Modbus
• b.	Baud rate	b.9600 b.19200 b.38400 b.76800	Baud rate 9600 Baud rate 19200 Baud rate 38400 Baud rate 76800
• bit.	Stop bits	bit.1 bit.2	1 stop bits 2 stop bits
• P.	Parity	P.odd P.even P.none	Odd parity Even parity Parity none
• Id.	Modbus Id/address	Id.x	Modbus id (x = value) *)
• PLA.	PLA address for Pascal	PLA.x	PLA address (x = value) *)
• ELA.	ELA address for Pascal	ELA.x	ELA address (x = value) *)
• Pi.	Pin-code	Pi.xxxx	Default: xxxx = 1111
• Store	Store changes		Stores changes on long press
• Cancel	Cancel		Cancel and ignore changes on long press

*) To change the value you need to long press until a blinking cursor appears under the first single number in the current value. After that you short press to toggle to the desired number, then you long press to move the blinking cursor to the next single number in the current value. Proceed until the new value has been set and long press to continue.

UltraLink® Monitor

FTMU

Digital communication settings

Registers 4x001-4x009 are used to configure communication settings. When initializing contact for the first time the default settings will be active;

Modbus id: Last three digits in the serial number (also visible in the display if the product has power)

Baud rate: 19200
Parity: Odd
Stop bits: 1

After updating any of the communication parameters the product needs to be power cycled for the changes to take effect.

PLEASE LOOK IN THE APPENDED MODBUS REGISTER FOR INSTRUCTIONS ON HOW TO CHANGE REGISTER VALUES. SOME VALUES HAS SCALE FACTORS AND SOME VALUES OCCUPY TWO REGISTERS!

All available settings are presented in the appendix. The settings can be changed via the RS485 bus and can be done from any device and configuration that can communicate using Modbus, but it can also be done via the OneLink app. For more register details see appendix.

Analog communication settings

Analog out settings via Modbus

Analog out is always active but you need to specify what kind of data you want to read on the two ports Analog Out 1 (AO1) and Analog Out 2 (AO2);

- Configure registers 4x401(AO1) and 4x431 (AO2) for the variables you want to read on the analog out terminals (0 = Flow, 1 = Temperature).
- Configure registers 4x400 (AO1) and 4x430 (AO2) for analog out level configuration ((0) 0-10V, (1) 10-0V, (2) 2-10V, (3) 10-2V)
- Configure registers 4x401-406 (AO1) and 4x431-436 (AO2) with relevant data for max and min levels for the voltage range selected in step 2. You only need to configure the max and min values corresponding to the variable selected in step 1.

Default values for the relevant registers related to “Analog Out 1” are according to the table below (Default values for flow max corresponds to 7 m/s).

Size Ø [mm]	4x400 Level Conf.	4x401 Unit Conf.	4x402 Temp Min [°C]	4x403 Temp Max [°C]	4x404 Flow Min [l/s]	4x406 Flow Max [l/s]
100	2 (2-10V)	0 (Flow)	0	50	0	55
125			0	50	0	86
160			0	50	0	141
200			0	50	0	220
250			0	50	0	344
315			0	50	0	546
400			0	50	0	880
500			0	50	0	1374
630			0	50	0	2182

Default values for the relevant registers related to “Analog Out 2” are according to the table below (Default values for flow max corresponds to 7 m/s).

Size Ø [mm]	4x430 Level Conf.	4x431 Unit Conf.	4x432 Temp Min [°C]	4x433 Temp max [°C]	4x434 Flow Min l/s]	4x436 Flow Max [l/s]
100	2 (2-10V)	1 (Temperature)	0	50	0	55
125			0	50	0	86
160			0	50	0	141
200			0	50	0	220
250			0	50	0	344
315			0	50	0	546
400			0	50	0	880
500			0	50	0	1374
630			0	50	0	2182

UltraLink[®] Monitor

FTMU

Troubleshooting

If digital communication fails, verify the following before contacting support

- Check settings for Baud rate, parity and stop bit and make sure the master uses the same settings as the UltraLinks. This can be done with a mobile phone and the OneLink app.
- -A and +B are continuously connected between all the products without any mixups of -A and +B.
- Bus layout is not allowed to be “star connection”.
- The cables for power supply are connected identical on all products and transformers connecting G to G (24V) and G0 to G0 (GND).
- The shield is continuous along the bus and grounded only at the transformer and the last UltraLink on the bus.
- There are not more than 30 devices on the bus. (Install a repeater if you have more than 30 devices.)
- The total length of the bus is maximum 300 m. (Install with a repeater if you have more than 300 m bus cable.)
- Try to establish communication with a PC using Configuration Tool and a biased RS485-USB converter.
- Keep the total length of stubbs (such as the premounted cable) of a buss with 30 devices, no more than 20 meters.

Problems accessing UltraLink via Bluetooth

- The UltraLink must have the Bluetooth logotype on the lid of the display unit in order to have a Bluetooth function.
- To access the UltraLink via Bluetooth, the correct PIN code must be input before being able to connect. Verify with administrator that the PIN code is correct if you cannot connect.

If analog signals fails, make sure to doublecheck the following

- Measure voltage on the screw terminal, the voltage should be the same as that on the BMS controller.
- If the voltage is not correct, check that the wire is firmly attach to the terminal of the UltraLink. If it is not, then the UltraLink might not be able to pick up the signal.

Error codes

If a problem occurs the status light will start to flash and an error code will be displayed. Listed in the table below are their problem and possible solution.



Error code	Problem	Comment
Err004	Problems with flow measurement	Might be caused by: <ul style="list-style-type: none"> • something blocking the flow sensors • an electronic fault • the flow sensors are not connected properly into the display unit • the sensor body is flawed • design of duct system is causing severe turbulence/disturbance
Err05	External sensor low battery	
Err06	External sensor not reporting	

UltraLink[®] Monitor

FTMU

Technical data

Technical data table

Power supply	AC/DC	24 (18-32) V
Cable	Max outer diameter	7 mm
Power consumption		0,4 W
Power consumption	For wiring	0,5 VA
Degree of protection	EN 60529	IP44
Tightness class to the environment	EN 12237	D
Storage temperature range		-30 to +50 °C
Maximum ambient moisture		95 % RH
Connection	RS485 standard or analog	
Cable	RS485 standard cable, 2-wire shielded twisted pair, min. 0,1 mm ² (LIYCY cable)	
Protocol	Modbus	
Output	Flow	m ³ /h
	Flow	l/s
	Velocity	m/s
	Temperature	°C
Velocity range	For guaranteed measurement uncertainty	0,2 - 15,0 m/s
Measurement uncertainty flow (assuming correct installation)	Depending on which is the greatest of the percentage or the absolute number for the specific products size.	±5 % or
		Dim. 100 = ±1,00 l/s
		Dim. 125 = ±1,25 l/s
		Dim. 160 = ±1,60 l/s
		Dim. 200 = ±2,00 l/s
		Dim. 250 = ±2,50 l/s
		Dim. 315 = ±3,15 l/s
		Dim. 400 = ±4,00 l/s
	Dim. 500 = ±5,00 l/s	
	Dim. 630 = ±6,00 l/s	
Temperature range		-10 to +50 °C
Measurement uncertainty temperature		±1 °C
Bluetooth radio	Frequency	2402 – 2480 MHz
	Output	-40 to +9 dB
Bluetooth range (free line of sight)	UltraLink	100 m
Firmware	Upgradable for optimal performance	

Airflows

Ø [mm]	0,2 m/s		7,0 m/s		15,0 m/s	
	m ³ /h	l/s	m ³ /h	l/s	m ³ /h	l/s
100	6	2	198	55	425	118
125	9	3	309	86	662	184
160	14	4	507	141	1087	302
200	23	6	792	220	1696	471
250	35	10	1237	344	2650	736
315	56	16	1964	546	4208	1169
400	90	25	3167	880	6786	1885
500	141	39	4948	1374	10603	2945
630	224	62	7855	2182	16833	4676

UltraLink® Monitor

FTMU

Appendix A – Modbus register

- Address :** Modbus register address (3x indicates Input & 4x indicates Holding)
- UltraLink® :** Type of UltraLink® where the register is available (Indicated by “x”)
- Name:** Name of register
- Description:** Short description of register.
- Data type:** Data type for register (16bit contained in one register, 32bit and float in two consecutive registers).
- Unit:** Unit for register value (if any).
- Div:** Scale factor for stored value (divide register value with “div” to get correct value).
- Default:** Default setting.
- Min:** Minimum value allowed for the register.
- Max:** Maximum value allowed for the register.
- Access:** RO for read only (Input registers) and RW for read and write (Holding registers).

Address	UltraLink®		Name	Description	Data type	Unit	Div	Default	Min	Max	Access
	FTCU	FTMU									
INPUT REGISTERS											
3x008	X	X	Product Nominal Size	Nominal diameter of duct	16bit	mm					RO
3x013	X	X	Unit Status	Current unit status: 0 = Normal mode; 1 = Locating flow; 2 = Override control; 3 = Error; 4 = Control loop regulating; 5 = Angle sensor calibrating	16bit						RO
Flow info											
3x150	X	X	Velocity in m/s	Velocity in m/s	Float	m/s					RO
3x152	X	X	Air flow in m³/h	Air flow in m³/h	Float	m³/h					RO
3x154	X	X	Air flow in l/s	Air flow in l/s	Float	l/s					RO
Temperature info											
3x200	X	X	Current temperature in °C	Temperature in degree celcius.	16bit	°C	10				RO
Alarms											
3x400	X	X	Alarm Register 1	Alarms 1-32 - bitwise: 1 = Motor not working. 2 = Angle sensor not working correctly. 3 = Flow setpoint not reached. 4 = Flow measure problems. 5 = External sensor low battery. 6 = External sensor not responding. 7 - 31 = Reserved for future use. 32 = Factory data is corrupted.	32bit						RO
Other											
3x500	X	X	Signal amplification	Current signal amplification	16bit			0	3	20	RO

* = the value depends on the dimension of the product.

UltraLink® Monitor

FTMU

Address	UltraLink®		Name	Description	Data type	Unit	Div	Default	Min	Max	Access
	FTCU	FTMU									
Sensor											
3x2001	X	X	Sensor Global Set Point Factor	Multiplication factor for flow set point	16bit		100	100			RO
3x2002	X	X	Sensor Global Factored Set Point	Holding register FLOW_SET_POINT (314) multiplied with SENSOR_GLOBAL_SET_POINT_FACTOR	16bit	l/s		0			RO
3x2007	X	X	Sensor Global State for Control	Current state of control: 0 = Off 1 = Unoccupied 2 = Normal 3 = Forced 4 = Delayed presence 5 = Temperature increase 6 = Temperature decrease 7 = CO2 decrease 8 = Humidity increase 9 = Humidity decrease 10 = VOC decrease 11 = Particles decrease 50 = Flow slave 100 = Clearing error 101 = Error C1 102 = Error C2 103 = Error C3 104 = Error C4 105 = Error C5 106 = Error C6							
3x2012	X	X	Sensor Com Current Presence Sum	Current Presence based on sum from all sensors	16bit			0			RO
3x2014	X	X	Sensor Com Presence State	0 = Disabled 1 = Unoccupied 2 = Normal 3 = Forced 4 = Delayed presence 5 = Error	16bit						RO
3x2021	X	X	Sensor Com Min. Temp	Minimum Temperature	16bit	degC	10				RO
3x2022	X	X	Sensor Com Max. Temp	Maximum Temperature	16bit	degC	10				RO
3x2023	X	X	Sensor Com Average Temp	Average Temperature	16bit	degC	10				RO
3x2025	X	X	Sensor Com Temp State	0 = Disabled, 1 = Within deadband, 2 = Outside deadband, 3 = Error	16bit						RO
3x2034	X	X	Sensor Com Summed Flow	Summed Flow	16bit	l/s	10				RO
3x2036	X	X	Sensor Com Flow State	0 = Disabled, 1 = Within deadband, 2 = Outside deadband, 3 = Error	16bit						RO
3x2041	X	X	Sensor Com Min. Humidity	Minimum Humidity	16bit	% RH	10				RO
3x2042	X	X	Sensor Com Max. Humidity	Maximum Humidity	16bit	% RH	10				RO
3x2043	X	X	Sensor Com Average Humidity	Average Humidity	16bit	% RH	10				RO
3x2045	X	X	Sensor Com Humidity State	0 = Disabled, 1 = Within deadband, 2 = Outside deadband, 3 = Error	16bit						RO
3x2051	X	X	Sensor Com Minimum CO ₂	Minimum CO ₂	16bit	ppm		0			RO
3x2052	X	X	Sensor Com Maximum CO ₂	Maximum CO ₂	16bit	ppm		0			RO
3x2053	X	X	Sensor Com Average CO ₂	Average CO ₂	16bit	ppm		0			RO

* = the value depends on the dimension of the product.

UltraLink[®] Monitor

FTMU

Address	UltraLink [®]		Name	Description	Data type	Unit	Div	Default	Min	Max	Access
	FTCU	FTMU									
3x2055	X	X	Sensor Com CO ₂ State	0 = Disabled, 1 = Within deadband, 2 = Outside deadband, 3 = Error	16bit						RO
3x2103	X	X	Sensor 1 Battery Level	Sensor 1 battery level	16bit	%		0			RO
3x2104	X	X	Sensor 1 RSSI	Sensor 1 RSSI	16bit	%		0			RO
3x2107	X	X	Sensor 1 Current Presence	Sensor 1 Current Presence	16bit			0			RO
3x2108	X	X	Sensor 1 Temperature	Sensor 1 Temperature	16bit	degC	10	0			RO
3x2109	X	X	Sensor 1 Flow	Sensor 1 Flow	16bit	l/s	10	0			RO
3x2110	X	X	Sensor 1 Humidity	Sensor 1 Humidity	16bit	% RH	10	0			RO
3x2111	X	X	Sensor 1 CO ₂	Sensor 1 CO ₂	16bit	ppm		0			RO
3x2123	X	X	Sensor 2 Battery Level	Sensor 2 battery level	16bit	%		0			RO
3x2124	X	X	Sensor 2 RSSI	Sensor 2 RSSI	16bit	%		0			RO
3x2127	X	X	Sensor 2 Current Presence	Sensor 2 Current Presence	16bit			0			RO
3x2128	X	X	Sensor 2 Temperature	Sensor 2 Temperature	16bit	degC	10	0			RO
3x2129	X	X	Sensor 2 Flow	Sensor 2 Flow	16bit	l/s	10	0			RO
3x2130	X	X	Sensor 2 Humidity	Sensor 2 Humidity	16bit	% RH	10	0			RO
3x2131	X	X	Sensor 2 CO ₂	Sensor 2 CO ₂	16bit	ppm		0			RO
3x2143	X	X	Sensor 3 Battery Level	Sensor 3 battery level	16bit	%		0			RO
3x2144	X	X	Sensor 3 RSSI	Sensor 3 RSSI	16bit	%		0			RO
3x2147	X	X	Sensor 3 Current Presence	Sensor 3 Current Presence	16bit			0			RO
3x2148	X	X	Sensor 3 Temperature	Sensor 3 Temperature	16bit	degC	10	0			RO
3x2149	X	X	Sensor 3 Flow	Sensor 3 Flow	16bit	l/s	10	0			RO
3x2150	X	X	Sensor 3 Humidity	Sensor 3 Humidity	16bit	% RH	10	0			RO
3x2151	X	X	Sensor 3 CO ₂	Sensor 3 CO ₂	16bit	ppm		0			RO
3x2163	X	X	Sensor 4 Battery Level	Sensor 4 battery level	16bit	%		0			RO
3x2164	X	X	Sensor 4 RSSI	Sensor 4 RSSI	16bit	%		0			RO
3x2167	X	X	Sensor 4 Current Presence	Sensor 4 Current Presence	16bit			0			RO
3x2168	X	X	Sensor 4 Temperature	Sensor 4 Temperature	16bit	degC	10	0			RO
3x2169	X	X	Sensor 4 Flow	Sensor 4 Flow	16bit	l/s	10	0			RO
3x2170	X	X	Sensor 4 Humidity	Sensor 4 Humidity	16bit	% RH	10	0			RO
3x2171	X	X	Sensor 4 CO ₂	Sensor 4 CO ₂	16bit	ppm		0			RO
3x2183	X	X	Sensor 5 Battery Level	Sensor 5 battery level	16bit	%		0			RO
3x2184	X	X	Sensor 5 RSSI	Sensor 5 RSSI	16bit	%		0			RO
3x2187	X	X	Sensor 5 Current Presence	Sensor 5 Current Presence	16bit			0			RO
3x2188	X	X	Sensor 5 Temperature	Sensor 5 Temperature	16bit	degC	10	0			RO
3x2189	X	X	Sensor 5 Flow	Sensor 5 Flow	16bit	l/s	10	0			RO
3x2190	X	X	Sensor 5 Humidity	Sensor 5 Humidity	16bit	% RH	10	0			RO
3x2191	X	X	Sensor 5 CO ₂	Sensor 5 CO ₂	16bit	ppm		0			RO
HOLDING REGISTERS											
Communication settings											
4x001	X	X	Communication id	Modbus address	16bit				1	239	RW
4x002	X	X	RS485 Baud Rate Conf.	Baudrate: 0 = 9600 1 = 19200 2 = 38400 3 = 76800	16bit			1	0	3	RW
4x003	X	X	RS485 Parity Conf.	Parity: 0 = Odd; 1 = Even; 2 = None	16bit			0	0	2	RW

* = the value depends on the dimension of the product.

UltraLink® Monitor

FTMU

Address	UltraLink®		Name	Description	Data type	Unit	Div	Default	Min	Max	Access
	FTCU	FTMU									
4x004	X	X	RS485 Stop Bit Conf.	Number of stopbits: 1 or 2.	16bit			1	1	2	RW
4x005	X	X	RS485 Protocol Conf.	Protocol: 0 = Modbus; 1 = Not used; 2 = Pascal;	16bit			0	0	2	RW
4x006	X	X	Bluetooth Password	Password which must be provided to pair Bluetooth devices. This password can always be changed from wired connection. From wireless it can only be changed when connection is established using current password.	16bit			1111	0000	9999	RW
4x007	X	X	Bluetooth Enable	Enable Bluetooth Communication 0 = Bluetooth turned off; 1 = Bluetooth turned on;	16bit			1	0	2	RW
4x008	X	X	PLA	ID used for Pascal	16bit				1	239	RW
4x009	X	X	ELA	ID used for Pascal	16bit				1	239	RW
4x010	X	X	Bluetooth TX Power Level	Configure TX Power Level dBm. Accepted values: -40, -20, -16, -12, -8, -4, 0, 2, 3, 4, 5, 6, 7, 8, 9	16bit			0	-40	9	RW
System configuration											
4x072	X	X	Installation as Extract or Supply	Specifies if device is in supply or extract: 0 = Undefined 1 = Supply 2 = Extract	16bit			0	0	2	RW
4x073	X	X	Installation Zone Number	Specifies in which zone the product is installed in	16 bit			0	0	65535	RW
4x074	X	X	Installation Floor Number	Specifies on which floor the product is installed in	16bit			0	0	65535	RW
4x082	X	X	Execute Factory Reset	Factory reset of all parameters. Unit will restart 0 = Do nothing; 1 = Factory Reset	16bit			0	0	1	RW
4x083	X	X	Execute Reboot	Reboot the unit 0 = Do nothing; 1 = Reboot the unit;	16bit			0	0	1	RW
Analog output											
4x400	X	X	Analog Output 1 Level Conf.	Analog output config: 0 = 0-10 V, 1 = 10-0 V, 2 = 2-10 V, 3 = 10-2 V.	16bit			2	0	3	RW
4x401	X	X	Analog Output 1 Unit Conf.	Show: 0 = Flow; 1 = Temperature; 2 = Angle;	16bit			0	0	2	RW
4x402	X	X	Analog Output 1 Temp. Min.	Min temperature shown = Min output voltage (Only relevant when 4x401 is set to 1)	16bit	°C		0	-40	50	RW
4x403	X	X	Analog Output 1 Temp. Max.	Max temperature shown = Max output voltage (Only relevant when 4x401 is set to 1)	16bit	°C		50	-40	50	RW
4x404	X	X	Analog Output 1 Flow Min.	Min flow shown = Min output voltage (Only relevant when 4x401 is set to 0)	16bit	l/s		0	-4700	4700	RW
4x406	X	X	Analog Output 1 Flow Max.	Max flow shown = Max output voltage (Only relevant when 4x401 is set to 0)	16bit	l/s		*	-4700	4700	RW
4x430	X	X	Analog Output 2 Level Conf.	Analog output config: 0 = 0-10 V, 1 = 10-0 V, 2 = 2-10 V, 3 = 10-2 V.	16bit			2	0	3	RW
4x431	X	X	Analog Output 2 Unit Conf.	Show: 0 = Flow 1 = Temperature 2 = Angle	16bit			2	0	2	RW

* = the value depends on the dimension of the product.

UltraLink® Monitor

FTMU

Address	UltraLink®		Name	Description	Data type	Unit	Div	Default	Min	Max	Access
	FTCU	FTMU									
4x432	X	X	Analog Output 2 Temp. Min.	Min temperature shown = Min output voltage (Only relevant when 4x431 is set to 1)	16bit	°C		0	-40	50	RW
4x433	X	X	Analog Output 2 Temp. Max.	Max temperature shown = Max output voltage (Only relevant when 4x431 is set to 1)	16bit	°C		50	-40	50	RW
4x434	X	X	Analog Output 2 Flow Min.	Min flow shown = Min output voltage (Only relevant when 4x431 is set to 0)	16bit	l/s		0	-4700	4700	RW
4x436	X	X	Analog Output 2 Flow Max.	Max flow shown = Max output voltage (Only relevant when 4x431 is set to 0)	16bit	l/s		*	-4700	4700	RW
Sensor											
4x2100	X	X	Sensor Presence Enable Control	0 = Disable 1 = Enable	16bit			0	0	1	RW
4x2101	X	X	Sensor Presence Trigger Time	Temporary trigger time for presence	16bit	min		1	0	60	RW
4x2102	X	X	Sensor Presence Trigger Factor	Factor related to toggle 0 -> 1	16bit	%	100	150	49	501	RW
4x2103	X	X	Sensor Unoccupied Multiplication Factor	Multiplication factor for Unoccupied	16bit	%	100	50	-1	101	RW
4x2110	X	X	Sensor Temperature Enable Control	0 = Disable 1 = max 2 = min 3 = avg	16bit			0	0	3	RW
4x2111	X	X	Sensor Temperature Baseline	Baseline for temperature	16bit	C		22	-50	50	RW
4x2112	X	X	Sensor Temperature Deviation	Allowed deviation before full factor effect	16bit	C		2	0	50	RW
4x2113	X	X	Sensor Temperature Dead Band	Dead band for sensor type Temperature	16bit	%	100	50	-1	101	RW
4x2114	X	X	Sensor Temperature Multiplication Factor	Multiplication factor for Temperature	16bit	%	100	150	49	501	RW
4x2120	X	X	Sensor Flow Enable Control	0 = Disable 1 = Sum	16bit			0	0	1	RW
4x2121	X	X	Sensor Flow Dead Band	Dead band for sensor type Flow	16bit	%	100	2	0	100	RW
4x2122	X	X	Sensor Flow Multiplication Factor	Multiplication factor for Flow	16bit	%	100	100	0	500	RW
4x2130	X	X	Sensor Humidity Enable Control	0 = Disable 1 = max 2 = min 3 = avg	16bit			0	0	3	RW
4x2131	X	X	Sensor Humidity Baseline	Baseline for humidity	16bit	%		50	0	100	RW
4x2132	X	X	Sensor Humidity Deviation	Allowed deviation before full factor effect	16bit	%		20	0	100	RW
4x2133	X	X	Sensor Humidity Dead Band	Dead band for sensor type Humidity	16bit	%	100	50	-1	101	RW
4x2134	X	X	Sensor Humidity Multiplication Factor	Multiplication factor for Humidity	16bit	%	100	150	49	501	RW
4x2135	X	X	Sensor Humidity Supplied	Estimated value of supply air humidity	16bit	%		50	0	100	RW
4x2140	X	X	Sensor CO ₂ Enable Control	0 = Disable 1 = max 2 = min 3 = avg	16bit			0	0	3	RW
4x2141	X	X	Sensor CO ₂ Baseline	Baseline for CO ₂	16bit	ppm		600	400	2000	RW
4x2142	X	X	Sensor CO ₂ Deviation	Allowed deviation before full factor effect	16bit	ppm		400	0	1000	RW
4x2143	X	X	Sensor CO ₂ Dead Band	Dead band for sensor type CO ₂	16bit	%	100	50	-1	101	RW
4x2144	X	X	Sensor CO ₂ Multiplication Factor	Multiplication factor for CO ₂	16bit	%	100	150	49	501	RW
4x2145	X	X	Sensor CO ₂ Supplied	Estimated value of supply air CO ₂	16bit	ppm		400	300	2000	RW

* = the value depends on the dimension of the product.



Most of us spend the majority of our time indoors. Indoor climate is crucial to how we feel, how productive we are and if we stay healthy.

We at Lindab have therefore made it our most important objective to contribute to an indoor climate that improves people's lives. We do this by developing energy-efficient ventilation solutions and durable building products. We also aim to contribute to a better climate for our planet by working in a way that is sustainable for both people and the environment.

[Lindab | For a better climate](#)