

Lindab **Munio**

Active chilled beam



Active chilled beam

Munio

Content

Lindab Munio, short description.....	3
Optimal functions.....	4
Hygiene	5
Construction	5
JetCone system for adjustment of air amount	6
Adjustment JetCone	6
Optimal Diffusion Pattern	6
Outlet front grilles and inlet faceplates.....	7
Hotel Room Requirements	8
Hotel Room Regulation.....	9
Variants	10
Colour.....	10
Plus features	10
Accessories.....	10
Dimensioning	11
Dimensioning, Example Cooling.....	12
Dimensioning, Example Heating.....	13
Pressure drop in water circuit, cooling/heating	14
Dimensioning Sound.....	15
Dimensioning, Sound L_{WA}	16
Dimensioning, Air velocity	17
Water connections	19
Dimensions	20
Ceiling types	22
LindQST - just a click away.....	23
Program text	24
Order code.....	24

Active chilled beam

Munio



Picture 1. Hotel room equipped with Munio.

Use

Lindab's active chilled beam Munio can be used for cooling, heating and ventilation. It has been developed for the installation and integration into bulkheads for example in hotels, in hospitals or for any other rooms with bulkheads.

Water valves, actuators, condensation guard Regula Secura, room controller Regula Combi and connection cards (i.e. Regula Connect) can all be integrated into the Munio beam.

Installation

Munio is mounted directly to concrete ceiling or indirectly via hangers (to achieve a certain distance above a recessed ceiling). Every recessed ceiling system could be installed underneath the unit (e.g. standard T-Bars, Gypsum or other) and one of Munio's different available inlet faceplates will enable a simple adaptation.

Munio has a horizontal back air-connection, but can easily be equipped with an elbow or flexible connection duct (Lindab BKMU-90-125 or DRATMFU-125) to achieve side connection.

The 4-pipe water-connection is available from both sides of the unit.

Worth noting

- Small dimensions (800 x 540 x 170), high capacity.
- Ventilation, cooling and heating as standard.
- JetCone, an innovative way of regulating the air volume.

- No need for filter because of it works with dry cooling
- Service & maintenance issues are limited.
- For bulkhead installation with full integration in architectural design.
- Easy installation.
- Telescoping connection with clip in for outlet front grille.
- Full access with low cost maintenance.
- Fulfils highest hygienic requirements.
- Low sound levels.
- Individual room regulation with customized control equipment (plus).
- Additional energy savings when used with free energy sources.
- The beam can be easily integrated/used in a Pascal water system to enable VAV/DCV.
- Lindab's active chilled beams are Eurovent-certified and tested according to EN-15116.

Key figures

Length:	800, 1000, 1200, 1400 mm
Width:	550 mm
Height:	170 mm
Capacity:	971 W (Munio- I-1000) 1121 W (Munio- I-1400)

Calculation setup

Room temp.:	25°C
Water temp.:	14–17°C,
Air temp.:	18°C,
Nozzle air pressure:	80 Pa,
Air flow:	25 l/s



Active chilled beam

Munio

Optimal functions

Despite the product's small external dimensions, the construction makes it possible to achieve a high cooling capacity based on the induction principle. Ventilation air is released through the nozzles into a dispersal zone, thereby creating a low static pressure.

The low pressure causes the warm air from the room to be induced into the ventilation air through the battery. The volume of the recirculated indoor air is two to five times the ventilation air.

The warm room air is cooled as it passes through the battery, which consists of aluminium pins with copper pipes filled with cold, running water. The heat from the room is absorbed through the aluminium pins and then transferred through the copper pipe to the water circuit and goes further to a central cooling unit.

Lindab Pascal Water Solution

VAV/DCV combined with active chilled beams

For an extra energy- and cost saving and environmentally friendly ventilation and cooling system, the Lindab Pascal Water solution should be applied. The Pascal solution will optimize the ventilation, cooling, heating and even lighting for a perfect indoor climate at the lowest running cost by combining the active chilled beam with VAV (Variable Air Volume) or DCV (Demand Controlled Ventilation) technique.

Please refer to: [Pascal Water Solutions](#)

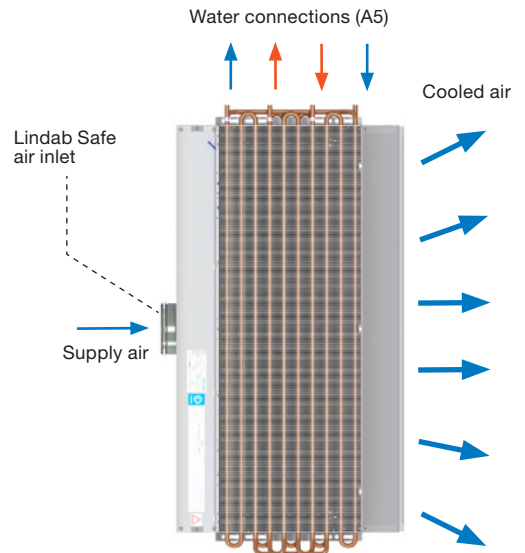
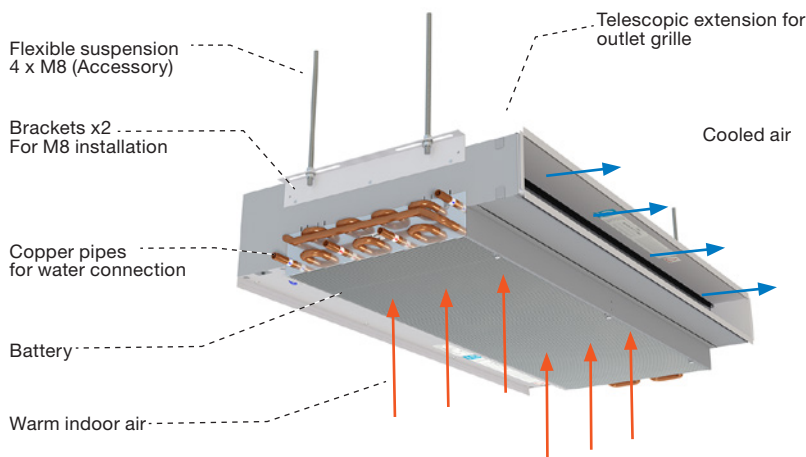

Picture 2a/b. Standard Munio-I-1000 (without inlet faceplate) parts and function principle.

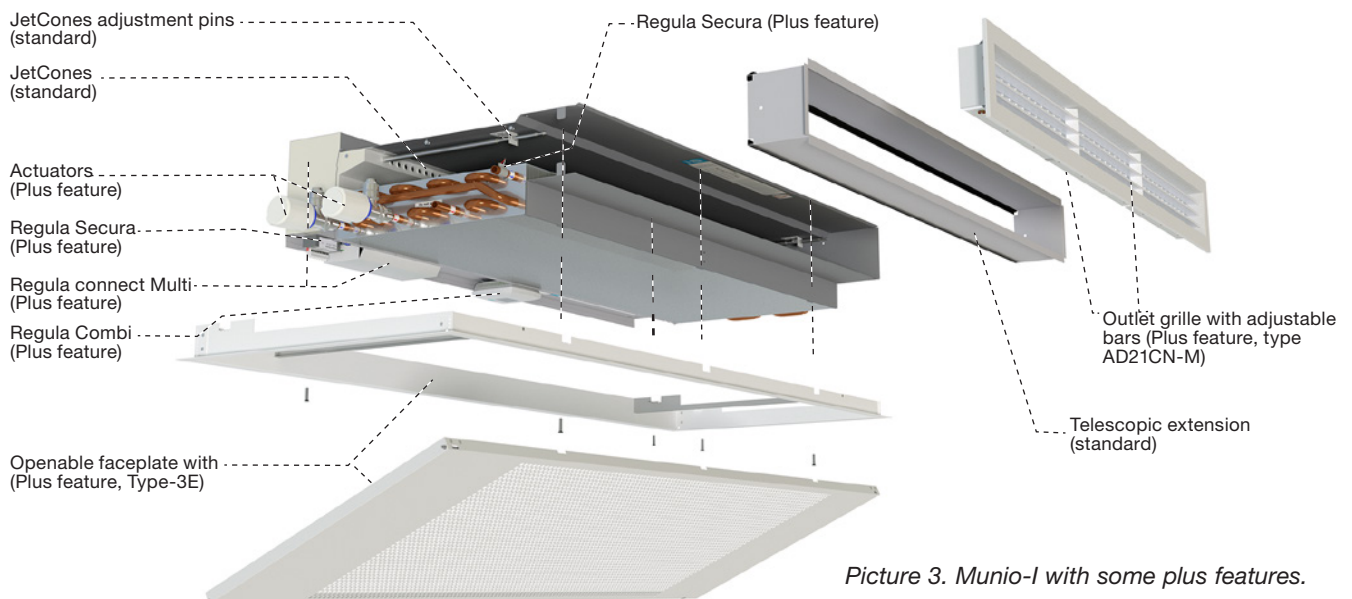

Picture 3. Munio-I with some plus features.

Active chilled beam

Munio

Hygiene

Everything is accessible

The Munio inlet faceplate can be lowered or removed easily. The faceplate is kept in place by four cotter pins. If two of the cotter pins, on one of the long sides of the faceplate are removed, the faceplate will open and hang from the other two pins. For complete removal, please see the installation instruction. When the faceplate is lowered or removed, the battery, optional Regula components (Regula Connect Card, Regula Secura or Regula Combi) and cleaning hatch for air inlet/plenum is accessible from below (see picture 4a).

If Munio is combined with one of the recommended Lindab outlet front grilles (AD21CN-M, AL21CN-M), the front grille could be removed without tools thanks to the standard springs, which fits to the units internal frame. If the front grille is removed full access to the inner part of the unit, like Jet-Cone adjustment pins, JetCone nozzles and upper part of the battery is guaranteed (see picture 4b).



Picture 4a. Munio-I opened inlet plate.



Picture 4b. Munio-I closed inlet and exploded outlet grille.

Inspection and Cleaning hatch

Munio comes as standard with an inspection and cleaning hatch, through this you can easily access the unit air inlet/plenum (see picture 5).



Picture 5. Cleaning hatch off.

Construction

Munio is developed and constructed to reach highest cooling capacity with minimum dimension and simplified installation features.

The JetCone System enables an easy and fast adjustment in both pressure and air volume through the front side. When Munio is equipped with Lindabs recommended outlet front grille type AD21CN-M (AL21CN-M) an additional adjustment of air distribution is possible.

The water battery is mounted horizontally, fully accessible and is always delivered with 4-pipe connection. If only cooling required the 2-pipes for heating will stay open (no connection).

The water pipes are made of copper. The water flowing through the beam should always be free from oxygen to guarantee that corrosion does not occur.

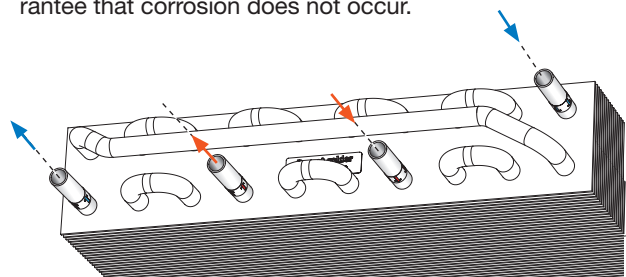

Picture 6. Munio-I battery - water connections.

Active chilled beam

Munio

JetCone system for adjustment of air amount

Munio is delivered as standard with Lindab's patent pending air volume adjustment system JetCone. JetCone makes Munio to a very flexible product with possibility of setting air volume and air pressure easily (without need of any tools).

The opening size of the straight supply air nozzles (0°) can be adjusted, by operating the two adjustment pins in each side of the beam (behind the outlet grille). The adjustment is done without any tools, which makes it very fast and easy to adjust (see [Munio Installation Instruction](#)).

The fast adjustment system gives an opportunity within planning, since the product choice can be made in an early stage and the products can be drawn into the planning of the project even though the planner do not have all the required data.

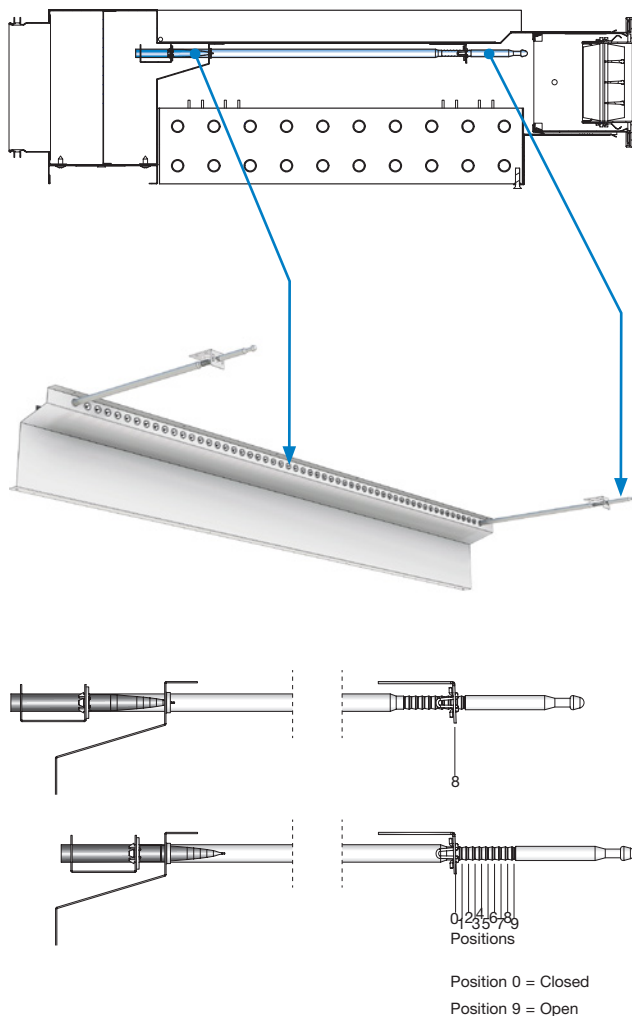

Picture 7 Munio's JetCone System.

Optimal Distribution Profile

Equipped with Lindab's recommended front outlet grille AD21CN-M (or AL21CN-M) adjustment of air distribution profile is possible with the vertical directional bars (see [Munio Installation Instruction](#)).

Setting of directional bars

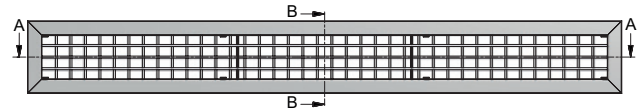

Picture 7a. Frontsight to outlet grille.

Setting of vertical directional bars settings

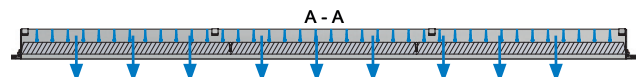

Picture 7b. All vertical directional bars in neutral position (0°).

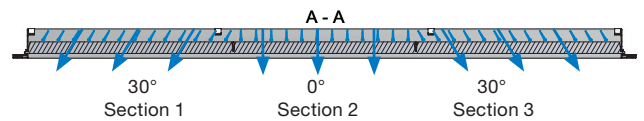

Picture 7c. All vertical directional bars in sections (30° - 0° - 30°).

Setting of horizontal directional bars (AD21CN-M only)

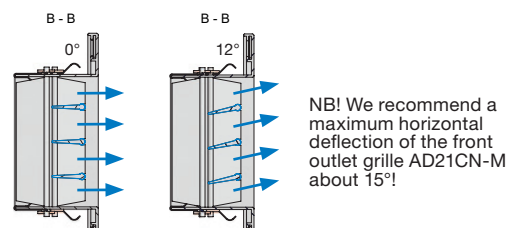

Picture 8a. Horizontal directional bars in neutral position (0°) and deflection of 12°.

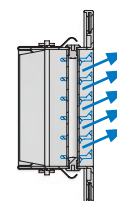

Picture 8b. AL21CN-M (15°), with fixed horizontal bars.

Active chilled beam

Munio

Outlet front grilles and inlet faceplates

To enable a flexible installation and a in-time delivery all outlet front grilles can be ordered separately.

Outlet front grilles (accessory)

We have customised four different standard aluminium grilles for Munio outlet. The different grilles have to be ordered separately to the unit and are all available powder coated in signal white RAL 9003 or in pure white RAL 9010, or natural anodised. They all are supplied as standard with clamp springs for direct installation in the Munio unit, without any visible means, like screws.

The AD21CN-M is a rectangular aluminium grille with adjustable horizontal and vertical directional bars for regulation of distribution profile 0° to 30°. For additional information see [AD21CN-M](#) and [AL21CN-M](#).

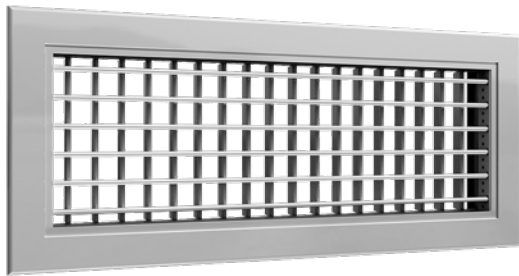

Picture 9. AD21CN-M (vertical and horizontal deflection bars in neutral position).

AL21CN-M is a rectangular aluminium grille with fixed horizontal, 15°-bended bars and an additional row of vertical directional bars for regulation of distribution profile 0° to 30°.

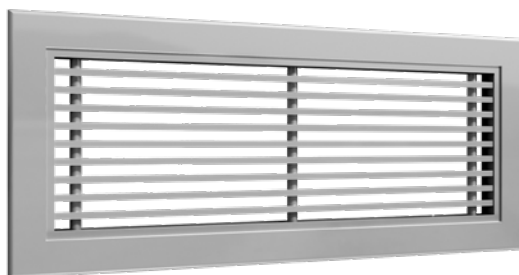

Picture 10. AL21CN-M with fixed horizontal bars and vertical deflection bars in neutral position.

Inlet Faceplates

There are different perforated inlet face plates available which can be fixed mounted to the unit:

- Inlet faceplate type -03 for installation recessed in suspended ceiling type 3 (e.g. gypsum) in width 505 mm (length: 844, 1045, 1245, and 1445 mm).
- Special Inlet faceplate type -3E for extra access to integrated valves and actuators for installation recessed in suspended ceiling type 3 (e.g. gypsum) in width 505 mm (length: 1175, 1375, 1575 and 1775 mm).

All of them guarantee full access to the water battery.

For installation without connection to the unit:

- Inlet faceplate type -01 and -21 for installation recessed in suspended t-bar ceiling type 1 or 21 (e.g. T24/Lay in; 600 x 600 mm or 625 x 625 mm).
- Inlet faceplate type -3S for installation recessed in suspended gypsum ceiling independent from Munio-I with means to install the faceplate frame directly in the ceiling type 3.

The faceplates are included in a frame and kept in place by four cotter pins. If two of the cotter pins, on one of the long sides of the faceplate are removed, the faceplate will open and hang from the other two pins. (Please check with ceiling supplier if weight is covered or hang separately).

Active chilled beam

Munio

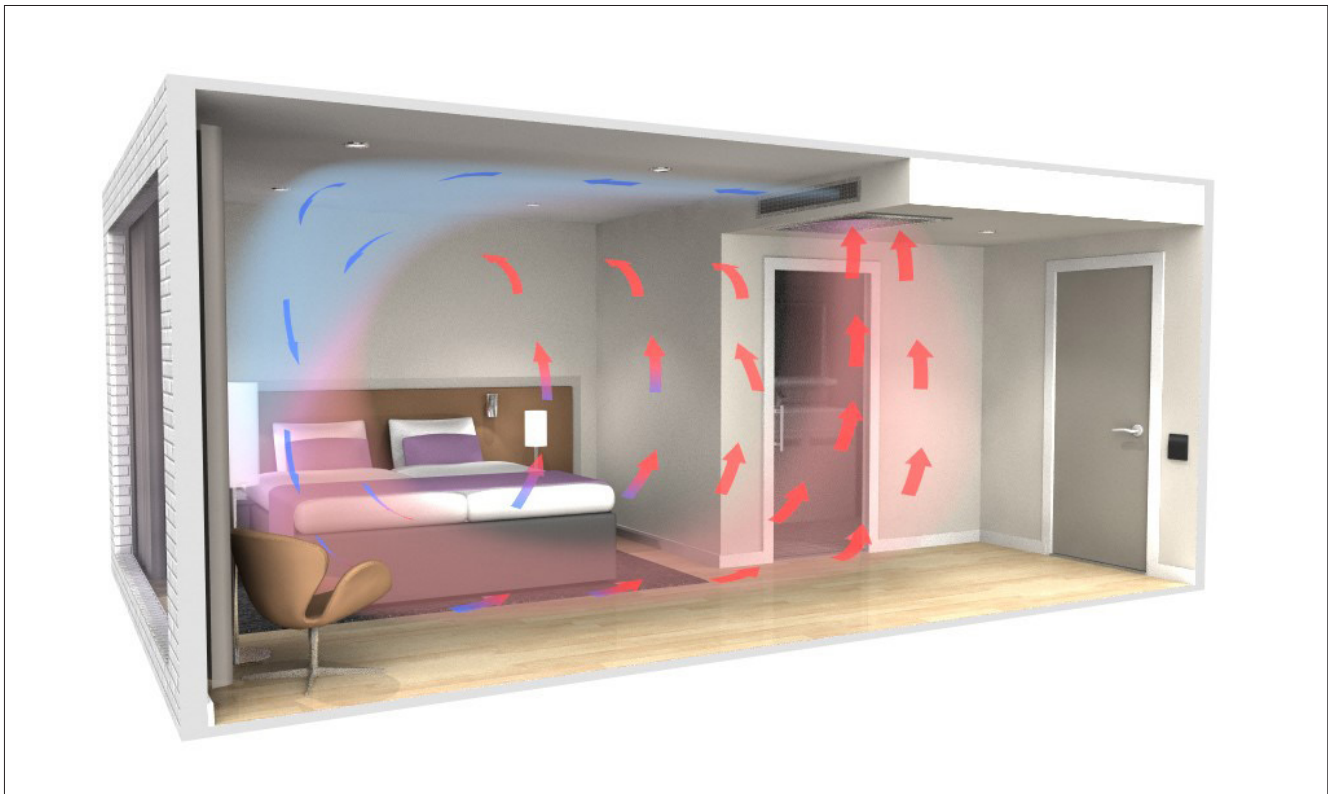

Picture 11. Hotel room equipped with Munio-I.

Hotel Room Requirements

Fresh air together with an independent and individually regulated room climate should be today's standard for a hotel room. The influences on the indoor climate are: fresh air rate, fresh air quality, indoor pollution (through toxics and odorants arising in the room), air velocity, room temperature and sound.

Hotel Room Ventilation

The central air handling units for the hotel rooms be equipped with a highly efficient heat exchanger and provide the rooms with fresh pre-conditioned supply air through ducts in the trunks and the corridors. The fresh air amount is to be calculated according to the amount of people considered to be in the room and the expected indoor air pollution will be, taking into account actual norms and regulations (i.e. EN 15251 "Indoor environmental input parameters for design and assessment of energy performance"). Every single Munio unit, mounted in the ceiling of the room entrance corridor, will be connected to the ventilation system and receives conditioned (fresh-)supply air.

The supply air will be lead into the room through the Munio outlet front grille, which is to be placed in the room wall, and should be exhausted through exhaust valves in the bathroom. The recirculated air will be forced through the perforated inlet faceplate and through the cooled or heated water battery before is will be mixed with the fresh supply air.

All hotel rooms should be equipped with a single room controller regulates by a temperature regulation (Regula Combi).

When the rooms are not occupied, they should only be ventilated and through the regulation only in winter times kept at a minimum temperature to avoid that, they are cooling out.

Hotel Room Cooling and Heating

To enable to regulate every single room climate independent, the Munio is equipped with both a cooling and a heating coil.

The water is cooled or heated centrally and natural sources like for example free cooling should be considered to optimize energy consumption. The cooling and heating units placed on the rooftop provide the unit via the water circuit (i.e. copper pipes in a 4-pipe or a 2-pipe system) through the trunks and corridors with cooled and/or heated water. Both water circuits are connected to the battery of the Munio with an inlet valve and an actuator, regulated by the room controller (Regula Combi). When cooling is required the room controller opens the cooling valve, and the recirculated warm room air, which is passing the battery, is cooling down. If heating is required the cooling valve is closed and the heating valve opens to heat the air via the battery.

The cooling water inlet pipe should be equipped with a condensation guard (Regula Secura) to avoid moisture on the battery.

Active chilled beam

Munio

Hotel room regulation

For a smart regulation of Munio in or example a hotel room we recommend our customized control equipment. There are: the room (zone) controller Regula Combi (communicates via Modbus, EXOline and Bacnet), integrated valves with actuators (if heating is separate, the valve should be equipped with an actuator and connected to our room controller via the Regula connect card), our condensation guard Regula Secura and a connection card for example Regula Connect Basic. Also external sensors and switches; for example a window contact switch and a key card reader or a presence sensor could be used.

The Regula Combi has in total 8 predefined programs, but program 1 is a water program. This is perfect for the regulation of temperature in sequences with heating, cooling and forced (cooling) ventilation.

Example: Standard settings for Regula Combi for hotel room regulation:

1a. Room booked, guest in	Regula Combi "OCCUPIED"
Setpoint heating	22°C
Setpoint cooling	23°C
Setpoint shift	+/- 3°C
Nominal air volume	
Card reader in room controls guests in/out	

Table 1. Example of hotel room regulation

1b. Room booked, guest out	Regula Combi "STANDBY"
Setpoint heating	20°C
Setpoint cooling	25°C
Setpoint shift	+/- 3°C
Nominal air volume	
Card reader in room controls guests in/out	

Table 2. Example of hotel room regulation

2a. Room not booked, guests expected	Regula Combi "UNOCCUPIED"
Setpoint heating	18°C
Setpoint cooling	26°C
Setpoint shift	no local Setpoint shift
Nominal air volume	
Manual setting	

Table 3. Example of hotel room regulation

2b Room not booked, no guests in	Regula Combi "OFF"
Setpoint heating	12°C
Setpoint cooling	can NOT be set
Nominal air volume	
Manual setting	

Table 4. Example of hotel room regulation

This is only an example. The regulation should be individual and should fulfil the requirements of the hotel owner. Lindab would be glad to assist you with this in a personal dialogue.

For more details of Regula Combi or Regula Components in general go to www.lindQST.com and search for "Regula".

Active chilled beam

Munio

Data



Picture 12. Munio-I-1000 (With inlet faceplate and outlet grille).

Munio

Munio-I is a rectangular comfort unit, for mounting in bulkheads, and is as standard prepared for ventilation, cooling and heating (4-pipe connection).

Length: Munio-I is available in length: 800 mm, 1000 mm, 1200 mm, 1400 mm.

Width: The width is always 550 mm.

Height: The Munio height is 170 mm (190 +10 mm with mounted inlet faceplate type 03 or 3E).

JetCone: The JetCone is a standard feature. The factory pre-settings will be done according to desired pressure (P_a) and supply air flow (l/s) and can be changed easily on site.

Heating: The product is standardly equipped with an additional water circuit in the battery to provide a heating function.

Water connection: The cooling and heating water connections for Munio-I are made of 12 mm copper pipes (always 4-pipe!).

Air connection: Munio-I is supplied with a air connection 125 mm with Lindab Safe® ducts.

Design: Munio-I is supplied with a perforation Dot2 (see picture 12), with 50% open area.

Surface treatment: Munio-I is manufactured as standard from galvanised sheet metal.

Inlet faceplate: Several inlet faceplate types are available as plus feature.

Pascal Water Solution

The beam can be easily integrated/used in a Pascal water system to enable VAV/DCV.

Please refer to: [Pascal Water Solution documentation](#)

Colour

The perforated inlet faceplate is available as standard, in signal white RAL 9003 or in pure white RAL 9010, gloss value 30. Other RAL colours on request.

Plus features

Factory preinstalled.

Enclosed valve and actuator: A control valve, with variable Kv value, and an actuator can be delivered with the product (when heating is needed, two sets of actuators and valves are needed).

Integrated Regula Secura: Lindab's Regula Secura condensation protection can be installed in the product. Please see "Regula Secura".

Integrated Regula Connect: The product can be equipped with the Regula Connect connection card. Please see "Regula Connect".

Inlet faceplates (mounted to Munio): We recommend the inlet faceplate type 03 and for full access to the integrated actuators a special inlet faceplate type -3E with wider outside length is available (see page 7 for description as accessory).

Integrated regulation unit: It is possible to have Lindab's room controller Regula Combi, pre-installed in the product. The control panel is fully accessible through the faceplate. Please see "Regula Combi".

Accessories

Delivered separately.

Munio outlet front grilles: Remember to order the Munio grilles: AD21CN-M or AL21CN-M (see page 7 for description).

Inlet faceplates (mounted to Munio): For full access to the integrated actuators a special inlet faceplate type - 3E with wider outside length is available (see page 7).

Inlet faceplate (separate from Munio): For installation recessed in suspended gypsum ceiling (e.g. ceiling type 3) the inlet faceplate type 3S t-bar ceiling is available. For other recessed lay-in ceilings (e.g. ceiling type 1; T24-Lay in; 600 x 600 mm or 625 x 625 ceiling type 21) inlet faceplates type -01 and -21 are available.

Hangers: For recommended installation principles (see [Munio Installation Instruction](#)):

All these different hangers are available at Lindab:

- pendulum hangers (in different sizes)
- threaded rods M8

For additional accessories please refer to the "Accessories" document on www.lindqst.com.

Active chilled beam

Munio

Dimensioning

Please note that dimensioning can be done easily and fast with “waterborne calculator” on www.lindQST.com.

Cooling capacity air P_a

1. Start by calculating the capacity required for the room, to keep a certain temperature. Lindab’s TEKNOsim is an excellent tool for this.
2. Calculate which cooling capacity, or read in diagram 1, that is supplied by the ventilation air.
3. Remaining cooling capacity needs to be cooled by the water circuit in Munio.

The formula for calculating the capacity of the air:

$$P_a = q_{ma} \times c_{pa} \times \Delta t_{ra}$$

Size comparison by $t_r = 25^\circ\text{C}$ with:

$$P_a \text{ [W]} = q_a \text{ [l/s]} \times 1.2 \Delta t_{ra} \text{ [K]}$$

and

$$P_a \text{ [W]} = q_a \text{ [m}^3\text{/h]} \times 0.33 \Delta t_{ra} \text{ [K]}$$

Minimum flow

Please note that flows below the recommended minimum water flow q_{wmin} , can result in unwanted air in the water pipes. Exceeding the nominal flows is not recommended as the capacity gains will only be minimal.

Pipe diameter	q_{wmin}	q_{wnom}
12 mm	0.025 l/s	0.038 l/s

Dimensioning

Cooling capacity water P_w

Follow the instructions to calculate the cooling capacity water P_w .

1. Calculate temperature difference between room air and mean water temperature. Δt_{rw} .
2. Product length L is equal to the active length L_{act} in meter (m).
3. Divide the primary air flow rate q_a by the active length L_{act} . Enter the result on the lower axis of diagram 2.
4. Follow the flow line to the right pressure, and then read off the specific cooling capacity P_{Lt} per active metre.
5. Calculate the temperature difference in water circuit Δt_w and find the capacity correction factor $\epsilon_{\Delta tw}$ in diagram 3.
6. Multiply the specific cooling capacity P_{Lt} that was read off by $\epsilon_{\Delta tw}$, Δt_{rw} and active length L_{act} .

Definitions:

- P_a = Cooling capacity air [W]
- P_w = Cooling capacity water [W]
- P_{tot} = Cooling capacity total [W]
- q_{ma} = Air mass flow rate [kg/s]
- q_a = Primary air flow rate [l/s]
- q_w = Water flow rate [l/s]
- q_{wmin} = Minimal water flow rate [l/s]
- q_{wnom} = Nominal water flow rate [l/s]
- c_{pa} = Specific heat capacity air [1.004 kJ/kg K]
- t_r = Room air temperature [$^\circ\text{C}$]
- t_{wi} = Water inlet temperature [$^\circ\text{C}$]
- t_{wo} = Water outlet temperature [$^\circ\text{C}$]
- Δt_{ra} = Temp. diff., room air and primary air temp. [K]
- Δt_{rw} = Temp. diff., room air and mean water temp. [K]
- Δt_w = Temp. diff. water circuit [K]
- $\epsilon_{\Delta tw}$ = Capacity correction for temperature
- ϵ_{q_w} = Capacity correction for water flow
- P_{Lt} = Specific cooling capacity [W/(m K)]

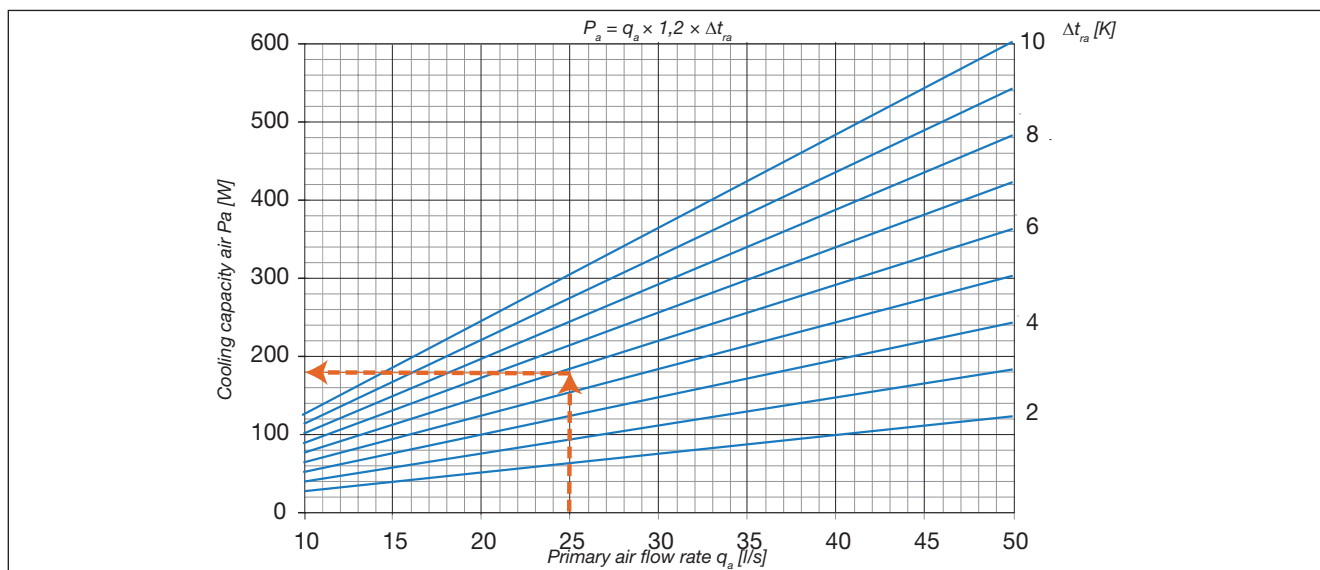

Diagram 1. Cooling capacity air P_a as function of the primary air flow rate q_a . If the air supply flow is 25 l/s and the temperature difference of the room air and the supply air is $\Delta t_{ra} = 6$ K, then the cooling capacity of the air is 180 W.

Active chilled beam

Munio

Example 1 Cooling:

What is the cooling capacity of a Munio I-1000 with AD21CN-M outlet front grille, 20 l/s and pressure of 80 Pa?

The room's summer temperature is assumed to be $t_r = 25.5^\circ\text{C}$. The cooling water temperature in/out of the Munio is $14/17^\circ\text{C}$.

Answer:

Temperature difference: $\Delta t_{rw} = t_r - (t_{wi} + t_{wo})/2$

$$\Delta t_{rw} = 25.5^\circ\text{C} - (14^\circ\text{C} + 17^\circ\text{C}) / 2 = 10 \text{ K}$$

Active length: $L_{act} = L = 1.0 \text{ m}$

$$q_a / L_{act} = 20 \text{ l/s} / 1.0 \text{ m} = 20 \text{ l/(s m)}$$

Read off, from diagram 2: $P_{Lt} = 70.5 \text{ W/(m K)}$.

Diagram 3 shows a capacity correction factor $\epsilon_{\Delta t_w}$:

$$\Delta t_w = t_{wi} - t_{wr} = 17^\circ\text{C} - 14^\circ\text{C} = 3 \text{ K}$$

$$\epsilon_{\Delta t_w} = 0.968.$$

Cooling capacity:

$$P_w = 70.5 \text{ W/(m K)} \times 0.968 \times 10 \text{ K} \times 1.0 \text{ m} = 682 \text{ W}.$$

NB! The capacity diagram applies for the nominal water flow of $q_{wnom} = 0.038 \text{ l/s}$. To obtain the right cooling capacity P_w for other flows, read off the capacity correction factor ϵ_{q_w} from diagram 4, and then multiply the calculated cooling capacity by this factor as shown in example 2 for heating.

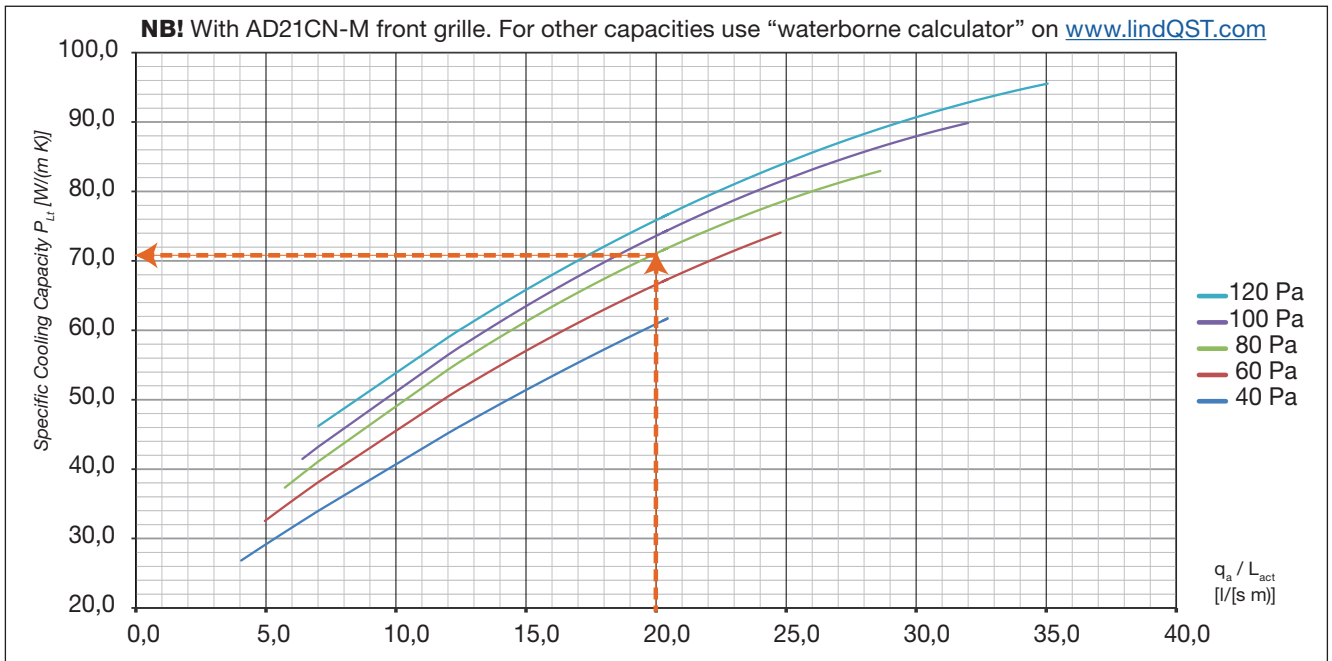

Diagram 2. Specific cooling capacity P_{Lt} for Munio with AD21CN-M outlet front grille.

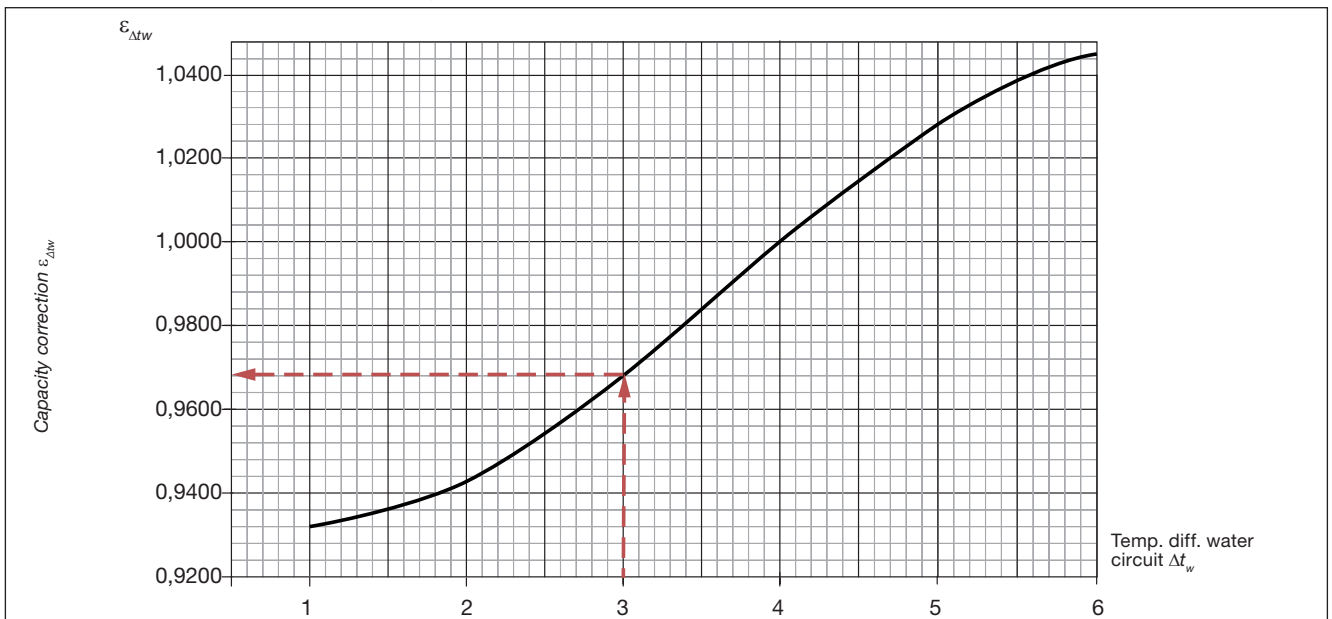

Diagram 3. Capacity correction $\epsilon_{\Delta t_w}$ as a function of Δt_w . Only applies for cooling.

Active chilled beam

Munio

Dimensioning

Capacity correction for water flow ϵ_{qw}

Example 2 Heating:

What is the heating capacity of a 2.4 m Munio-I-1000 with AD21CN-M outlet front grille, 25 l/s and pressure of 80 Pa?

The room winter temperature is assumed to be $t_r = 21^\circ\text{C}$.

The hot water temperature in/out of Munio is 55/50°C.

Answer:

Temperature difference:

$$\Delta t_{rw} = (t_{wi} + t_{wo}) / 2 - t_r$$

$$\Delta t_{rw} = (55 + 50) / 2 - 21 = 31.5 \text{ K}$$

Active length:

$$L_{act} = L = 1.0 \text{ m}$$

$$q_a / L_{act} = 25 \text{ l/s} / 1.0 \text{ m} = 25 \text{ l/(s m)}$$

Read off, from diagram 2:

$$P_{Lt} = 78.5 \text{ W/(m K)}$$

Water capacity:

$$P_w = 78.5 \text{ W/(m K)} \times 31.5 \text{ K} \times 1.0 \text{ m} = 2473 \text{ W}$$

Use the calculated water capacity and calculate the water flow:

$$q_w = P_w / (c_{pw} \times \Delta t_w)$$

$$q_w = 2473 \text{ W} / (4200 \text{ Ws/(kg K)} \times 5 \text{ K}) = 0.1178 \text{ l/s}$$

The capacity correction ϵ_{qw} will then be 0.35 (see diagram 4) and the new capacity:

$$P_w = 2473 \text{ W} \times 0.35 = 866 \text{ W}$$

Using the new heating capacity, a new water flow is calculated:

$$q_w = 866 \text{ W} / (4200 \text{ Ws/(kg K)} \times 5 \text{ K}) = 0.0412 \text{ l/s}$$

Read off the capacity correction ϵ_{qw} at 0.409 and calculate the capacity:

$$P_w = 2473 \text{ W} \times 0.409 = 1011 \text{ W}$$

Using the new heating capacity, a new water flow is calculated:

$$q_w = 1011 \text{ W} / (4200 \text{ Ws/(kg K)} \times 5 \text{ K}) = 0.04816 \text{ l/s}$$

Using the latest heating capacity, a new water flow is calculated:

$$q_w = 866 \text{ W} / (4200 \text{ Ws/(kg K)} \times 5 \text{ K}) = 0.0414 \text{ l/s}$$

Read off the capacity correction ϵ_{qw} at 0.414 and calculate the capacity:

$$P_w = 2473 \text{ W} \times 0.414 = 1024 \text{ W}$$

Seeing that the flow is near stable at this point in the calculation, the heating capacity is calculated to be 1024 W.

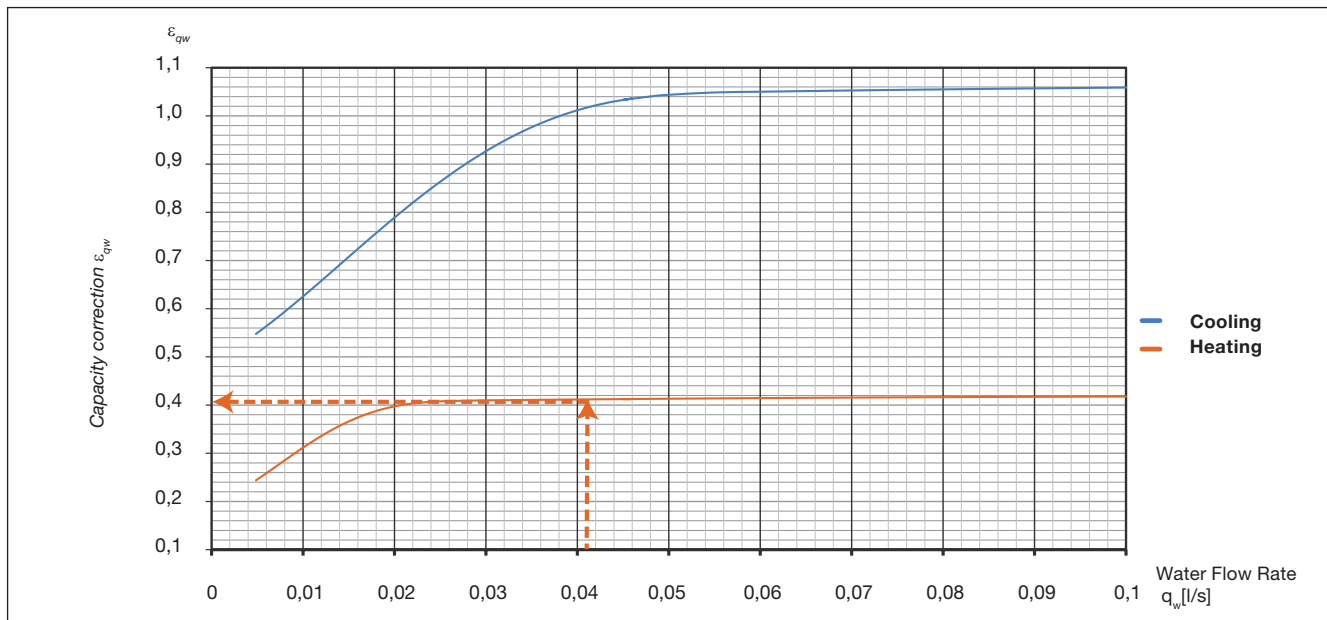

Diagram 4. Capacity correction ϵ_{qw} for water flow for both cooling and heating.

Active chilled beam

Munio

Pressure drop in water circuit, cooling/heating

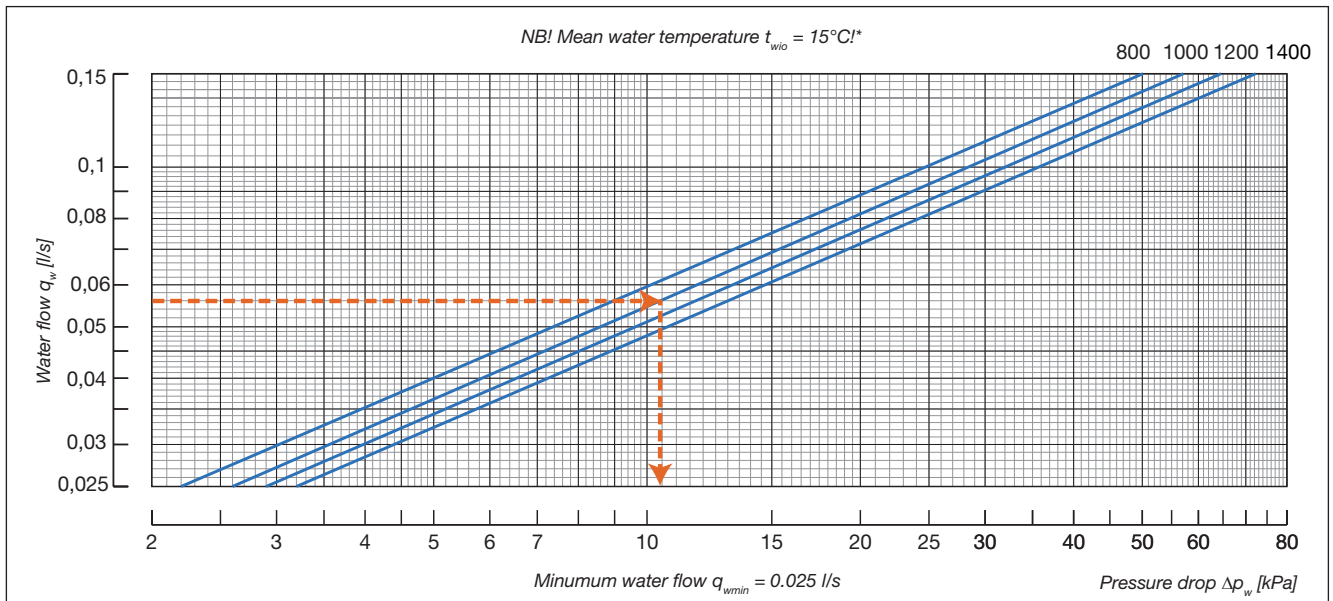

Diagram 5.a: Pressure drop in water circuit, cooling.

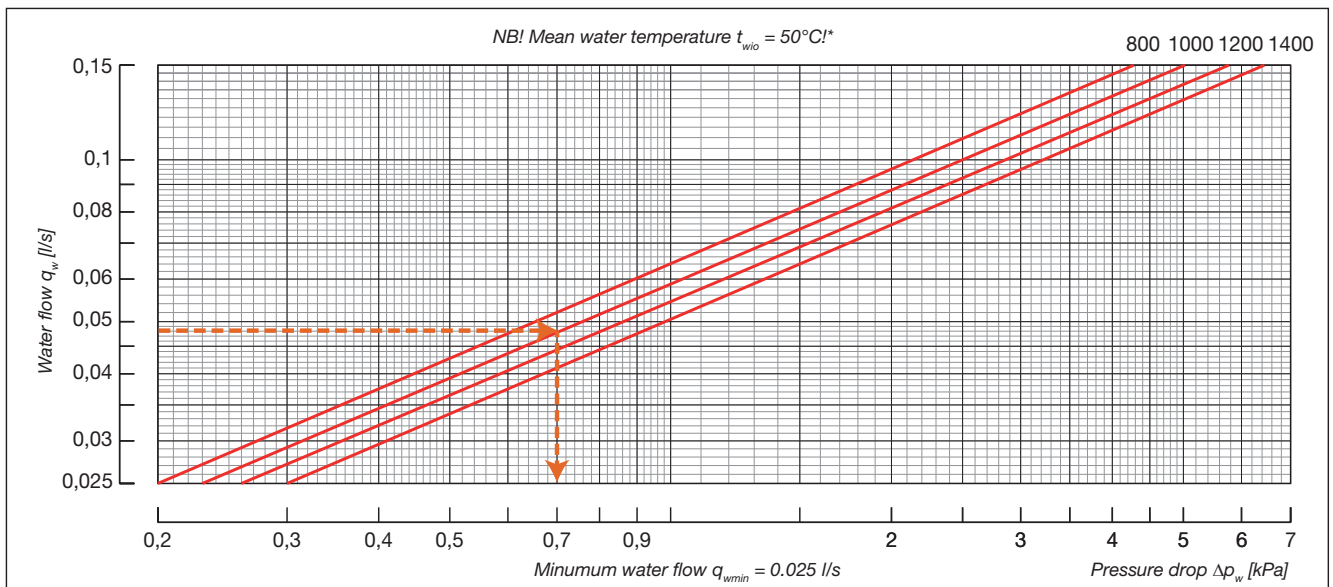

Diagram 5.b: Pressure drop in water circuit, heating.

Example 3 Cooling:

Munio-I-1000 which provides on output of 686 W.

$$\Delta t_w = 3 \text{ K}, q_w = P_w / (c_{pw} \times \Delta t_w)$$

$$q_w = 686 \text{ W} / (4200 \text{ Ws}/(\text{kg K}) \times 3 \text{ K}) = 0.05441 \text{ l/s}$$

The pressure drop in the water is read off as 10.9 kPa.

Example 4 Heating:

Munio-I-1000, which provides on output of 1024 W, 12 mm pipes.

$$\Delta t_w = 5 \text{ K}, q_w = P_w / (c_{pw} \times \Delta t_w)$$

$$q_w = 1024 \text{ W} / (4200 \text{ Ws}/(\text{kg K}) \times 5 \text{ K}) = 0.04875 \text{ l/s}$$

The pressure drop in the water is read off as 0.7 kPa.

Definitions:

q_w = Water flow rate [l/s]

P_w = Cooling/heating capacity water [W]

c_{pw} = Specific heat capacity water [4200 Ws/(kg K)]

Δt_w = Temperature difference water circuit [K]

Δp_w = Pressure drop [kPa]

t_{wio} = Mean water temperature [°C]

*Diagrams are for a certain mean water temperature t_{wio} . For other temperatures please do your calculations in our water-borne calculator on www.lindqst.com!

Active chilled beam

Munio

Dimensioning Sound

Pressure drop in air connection

The total pressure loss Δp_t [Pa], is calculated by calculating the necessary static pressure before the nozzles Δp_{stat} [Pa] for the active chilled beam and add the pressure drop Δp_a [Pa] in the air connection from Table 3.

Example 5:

Munio-I-1000-12-125-A5 with 20 l/s and static nozzle pressure Δp_{stat} of 80 Pa. This provides the necessary total pressure in $\Delta p_t = \Delta p_{stat} + \Delta p_a = 80 \text{ Pa} + 2 \text{ Pa} = 82 \text{ Pa}$.

Munio attenuation ΔL [dB], between air duct and room including end reflection.

Munio sound attenuation ΔL [dB]								
Lengths	63Hz	125Hz	250Hz	500Hz	1kHz	2kHz	4kHz	8kHz
800	18	10	7	6	5	6	10	16
1000	18	10	7	5	5	6	10	16
1200	19	11	7	3	5	7	10	15
1400	19	12	7	2	5	7	10	15

Table 5. Sound attenuation ΔL .

Munio noise levels for each octave band in the beam are calculated by adding the corrections K_{ok} from the table below to the sound effect level L_{WA} [dB(A)].

Munio sound level K_{ok}								
Lengths	63Hz	125Hz	250Hz	500Hz	1kHz	2kHz	4kHz	8kHz
800	6	-5	-4	-4	-6	-7	-9	-15
1000	6	-7	-3	-3	-5	-8	-11	-15
1200	7	-7	-3	-4	-5	-7	-9	-14
1400	6	-7	-5	-6	-7	-5	-9	-16

Table 6. Noise level K_{ok} .

Munio air pressure drop Δp_a									
Air Flow [l/s]	10	15	20	25	30	35	40	45	50
Pressure drop [Pa]	0	1	2	3	5	7	10	13	16

Table 7. Air Pressure drop Δp_a .

Active chilled beam

Munio

Dimensioning, sound L_{WA}

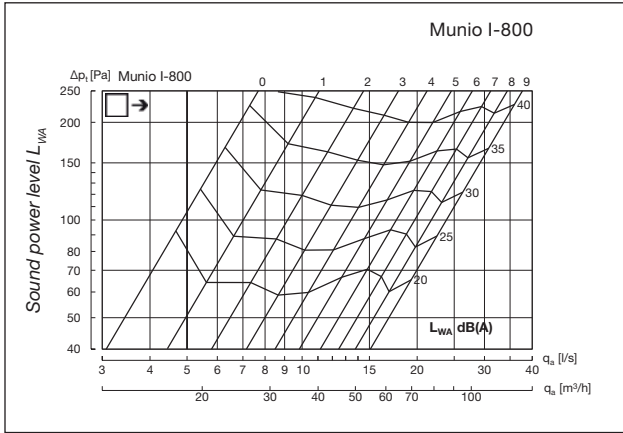

Diagram 6.a. Sound power level L_{WA} Munio I-800.

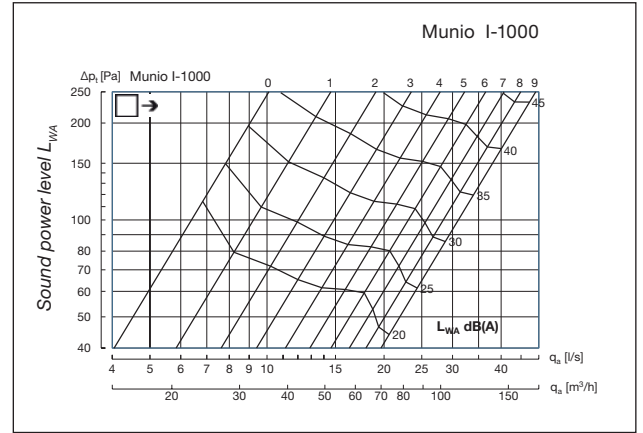

Diagram 6.b. Sound power level L_{WA} Munio I-1000.

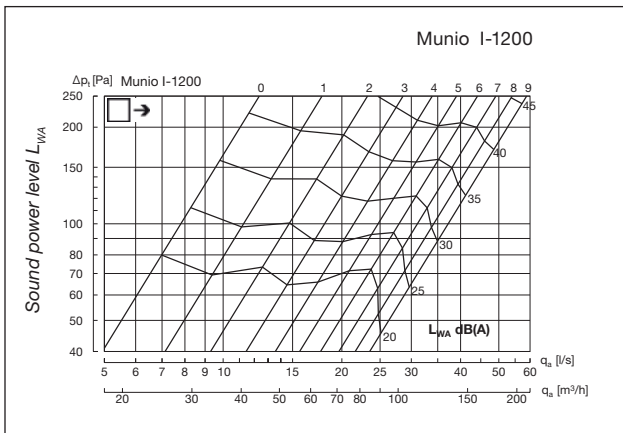

Diagram 6.c. Sound power level L_{WA} Munio I-1200.

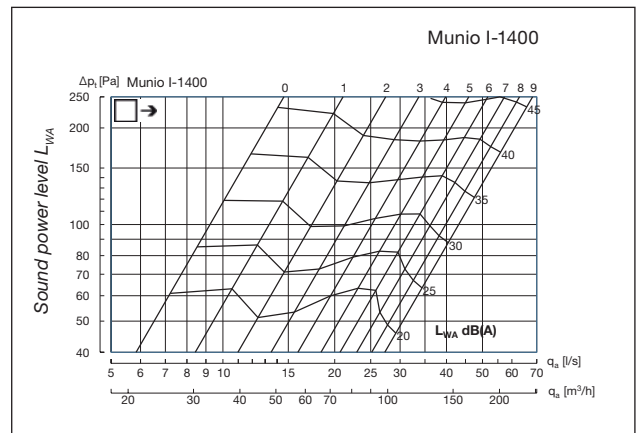

Diagram 6.d. Sound power level L_{WA} Munio I-1400.

Active chilled beam

Munio

Dimensioning, Air velocities

Distribution diagrams Munio for standard distribution profile (30° - 0° - 30°)

The measurements for a Munio-I-1000 are performed with a $\Delta t_{ra} = 5$ K and a $\Delta t_{rw} = 8$ K. The primary air flow rate is $q_a = 20$ l/s and the static pressure of the beam is $\Delta p_{stat} = 80$ Pa.

Other design criteria can be done easily and fast with “indoor climate designer” on www.lindQST.com.

Calculations for other distances between cooling baffles and for the selection of other air volumes are referred to the Indoor Climate Program.

www.lindQST.com/waterborne/calculator/default.aspx.

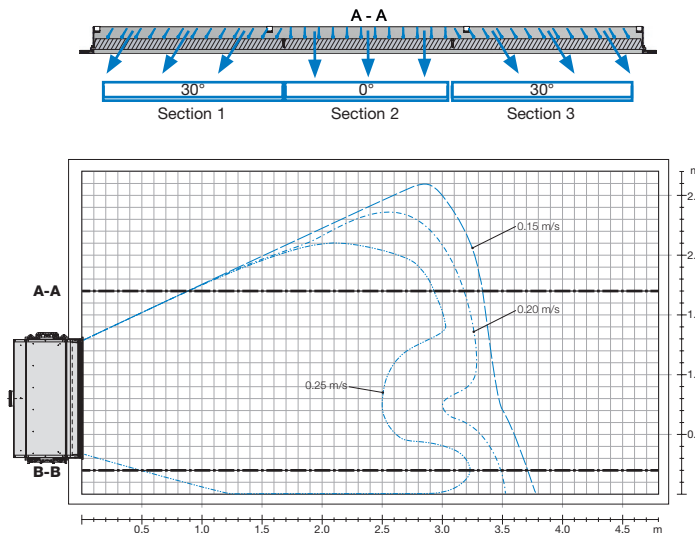

Figure 1: Top view - Air velocities for standard distribution profile (30° - 0° - 30°).

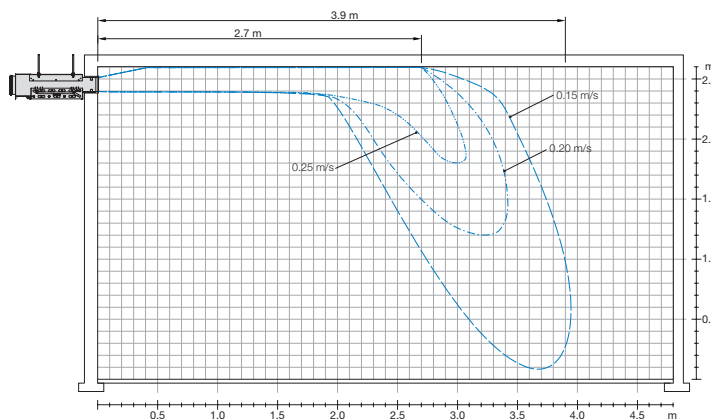

Figure 2: Side view A-A - Air velocities for standard distribution profile (30° - 0° - 30°).

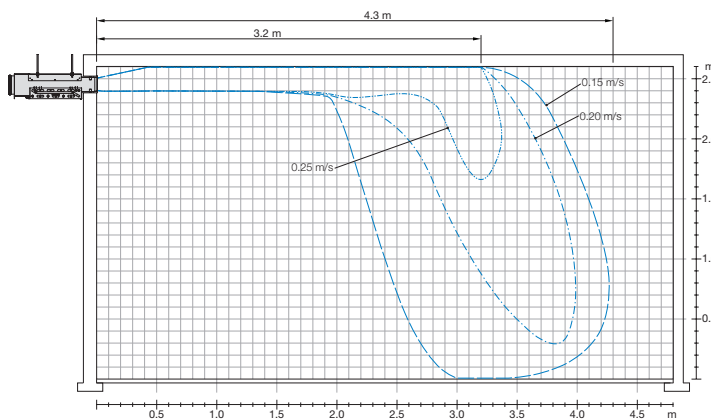
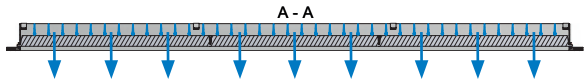

Figure 3: Side view B-B - Air velocities for standard distribution profile (30° - 0° - 30°).

Active chilled beam

Munio

Distribution diagrams Munio for neutral distribution profile (0°).



The measurements for a Munio-I-1000 are performed with a $\Delta t_{ra} = 5$ K and a $\Delta t_{rw} = 8$ K. The primary air flow rate is $q_a = 20$ l/s and the static pressure of the beam is $\Delta p_{stat} = 80$ Pa.

Other design criteria can be done easily and fast with “indoor climate designer” on www.lindQST.com.

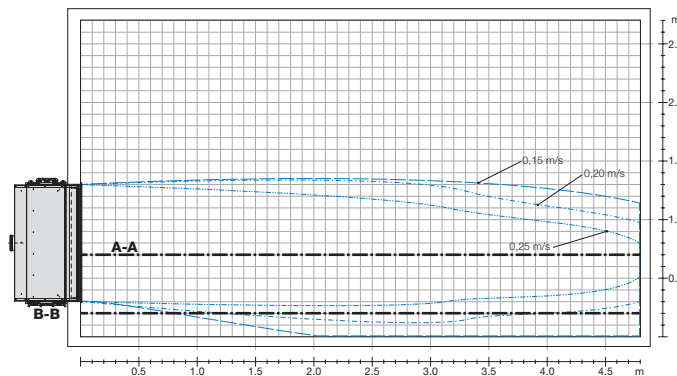

Figure 4: Top view - Air velocities for neutral distribution profile (0°).

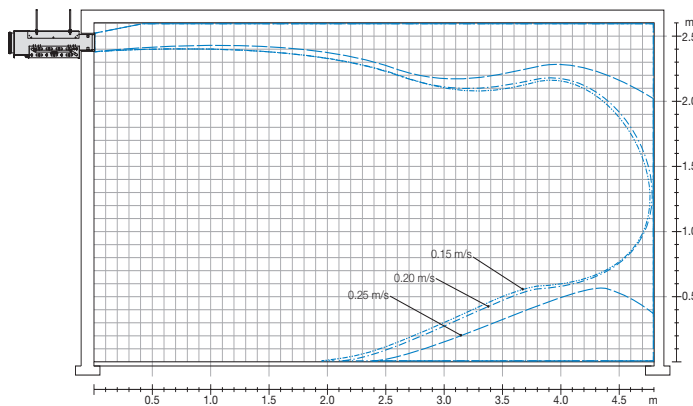

Figure 5: Side view A-A - Air velocities for neutral distribution profile (0°).

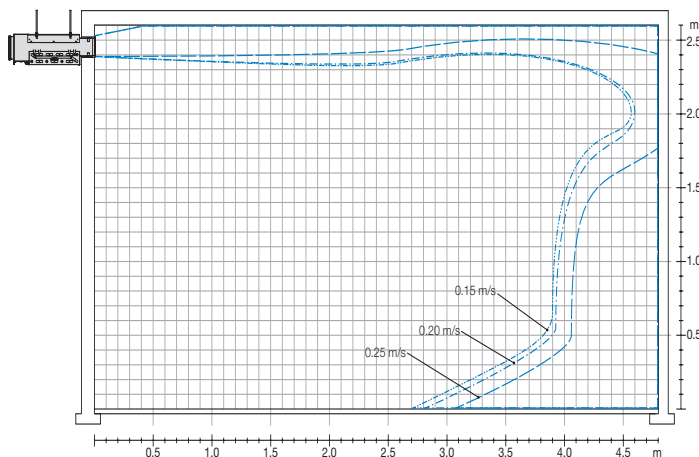

Figure 6: Side view B-B - Air velocities for neutral distribution profile (0°).

Active chilled beam

Munio

Connections

The pictures below show the connection possibilities A5 and A6 for Munio. Munio has horizontally back connection for supply air (A) and a 4-pipe water connection at the left or at the right side, seen in the direction of the air connection.

Water connection Ø12 mm; 4-pipes (5/6).

Supply air connection Ø125 mm (A).

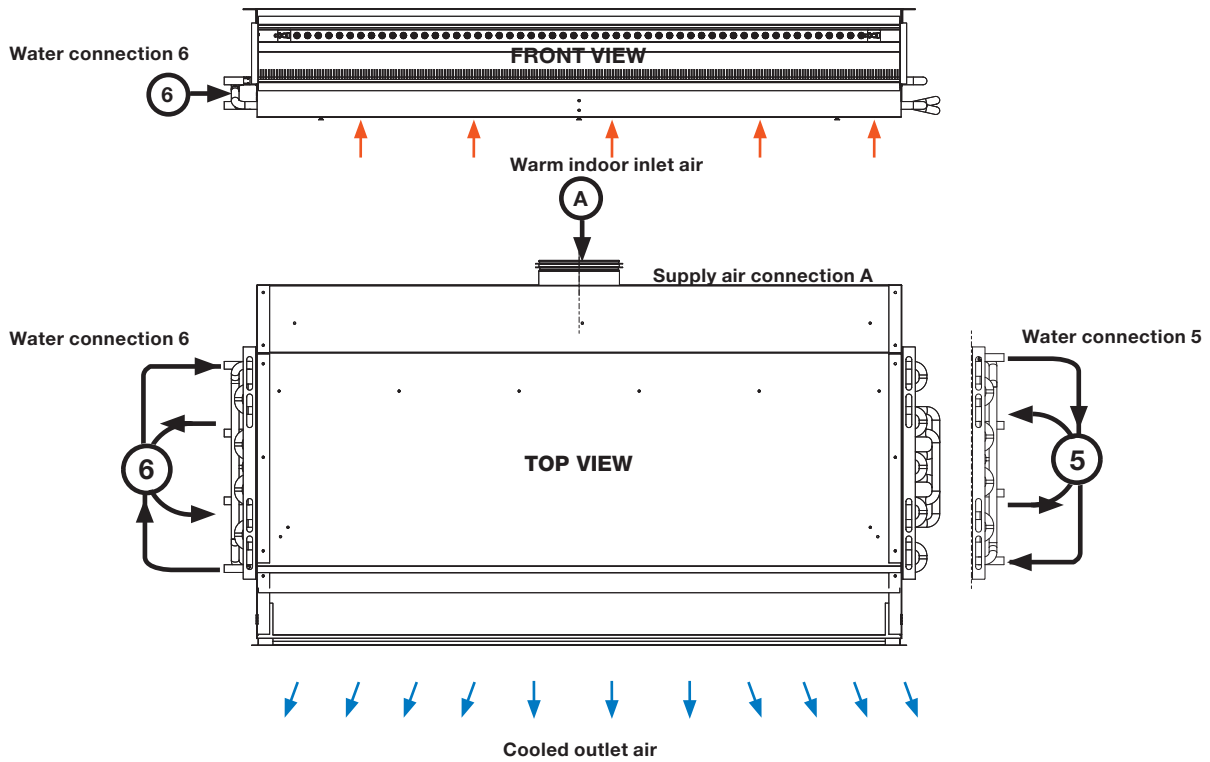

Figure 7. Supply air (A) and water connections (5 or 6) for Munio-I.

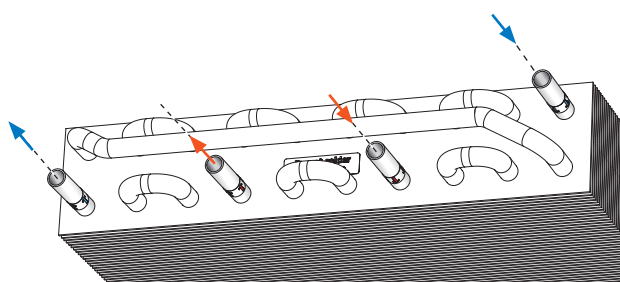

Figure 8. Placement of cooling and heating pipes (12 mm) on the battery. NB! When compression couplings are used, support sleeves must be applied.

Battery in A6 position

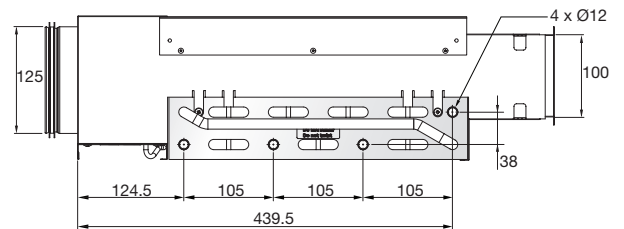

Figure 9. Munio-I placement of connections.

Active chilled beam

Munio

Dimensions

Examples below show Munio-I with A6 connection.

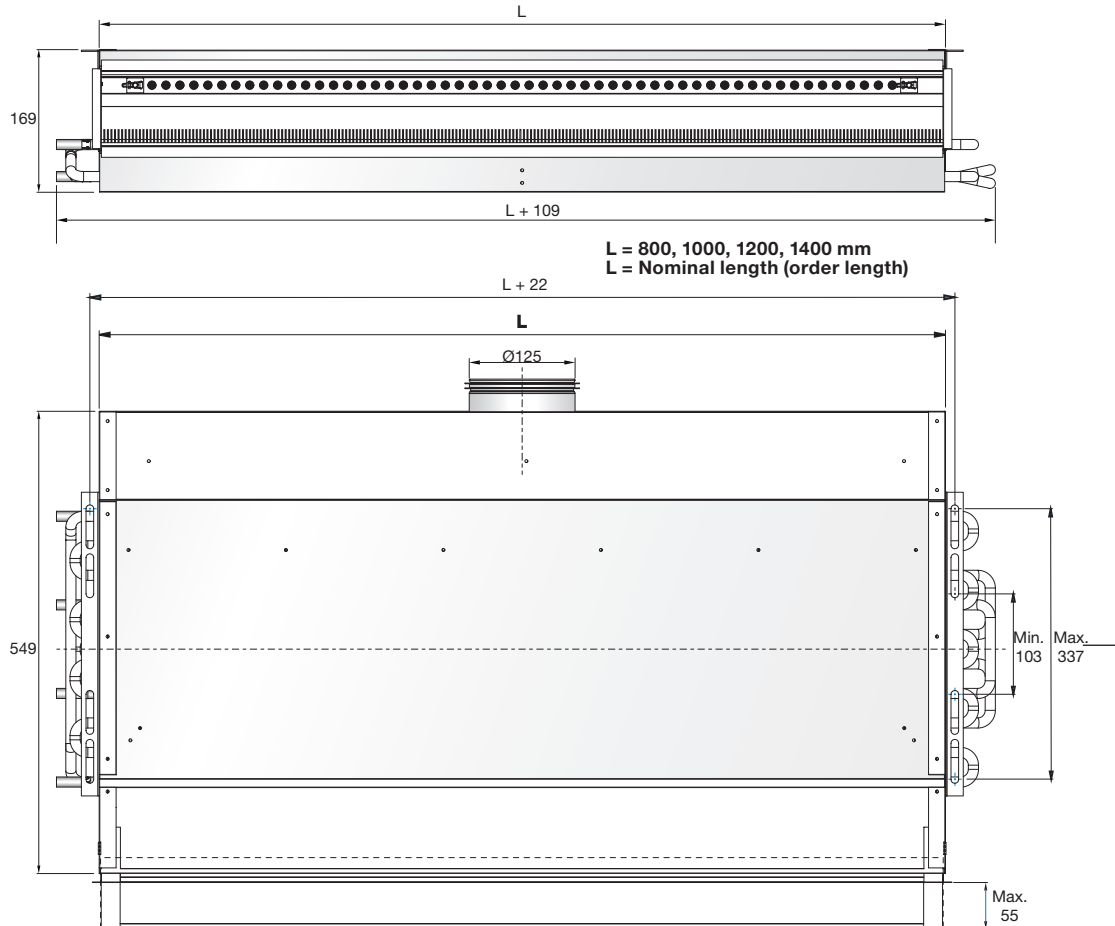
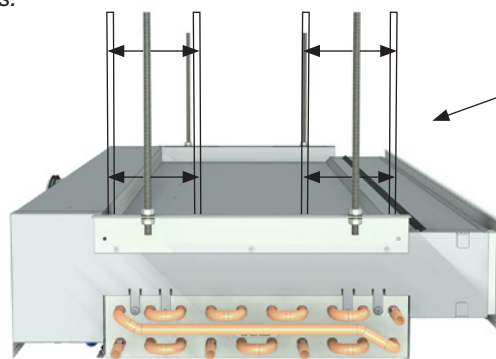

Figure 10. Munio-I outside dimensions.



Picture 13. Munio-I suspension. Different types of hangers are available as accessory.

Type	Munio I-800	Munio I-1000	Munio I-1200	Munio I-1400
Dry weight [kg]	12.1	14.7	17.3	19.9
Water content, cooling [l]	1.63	2.04	2.44	2.85
Water content, heating [l]	0.18	0.23	0.27	0.32
Copper pipes quality	EN 12735-2 CU-DHP			
Pressure class	PN10			

Table 8. Munios weight and water volume.

Active chilled beam

Munio

Bulkhead integration and ceiling types

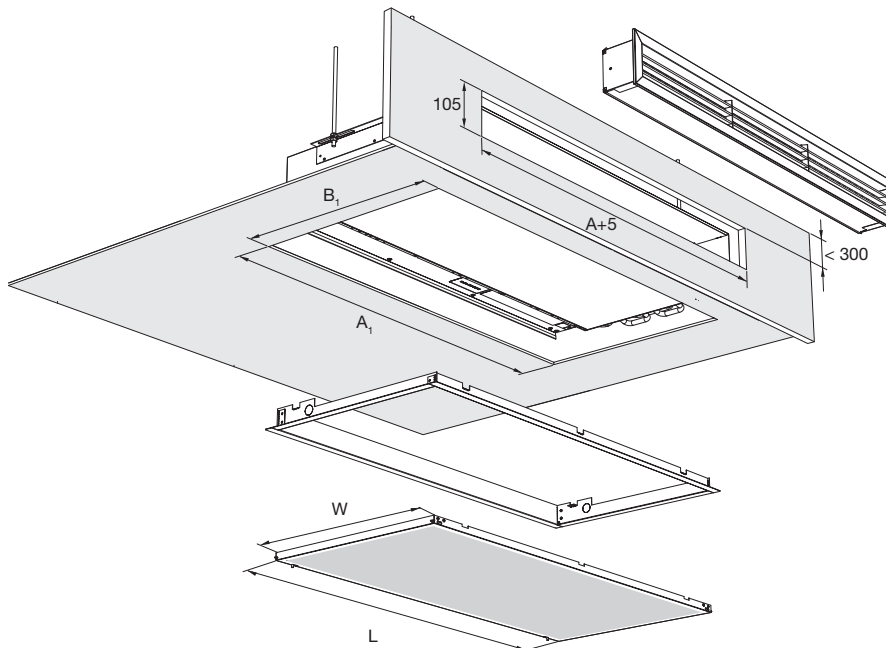

Figure 11: Bulkhead integration and cutout dimensions.

Inlet faceplate cutout dimensions

The cutout dimensions A_1 and B_1 for inlet faceplates are:

$$A_1 = L_{\text{Inlet}} - 25 \text{ mm} \quad \text{and} \quad B_1 = W_{\text{Inlet}} - 25 \text{ mm}$$

Order code	Order type	Munio-I		Inlet faceplate				Weight
				L_{Inlet}	W_{Inlet}	Cutout		
		L	Width			A_1	B_1	
				[mm]				[kg]
		Inlet faceplate -03 mounted to Munio (SHORT version)						
03		800	549	844	505	820	480	2.8
03		1000		1045		1020		3.2
03		1200		1245		1220		3.7
03		1400		1445		1420		4.1
		Inlet faceplate -01 and -21 separate from Munio for lay-in ceiling						
01	1	1200	600	1193	593	- *	- *	3.5
21	21	1200	625	1243	618	- *	- *	3.7
		Inlet faceplate -3S separate from Munio mounted into the ceiling						
3S		1200	549	1193	593	1168	568	4.6
		Inlet faceplate -3E mounted to Munio (LONG version)						
3E		800	549	1175	505	1150	480	3.6
3E		1000		1375		1350		4.1
3E		1200		1575		1550		4.5
3E		1400		1775		1750		5.0

Table 9. Munio cutout sizes, dimensions and weights for different inlet face plates.

***NB!** Ceiling type 1 and 21 do not have a cutout. The inlet faceplates lay-in freely in T24/T15 ceilings. (Please check with ceiling supplier if weight is covered or hang separately).

Active chilled beam

Munio

Bulkhead integration and ceiling types

Inlet faceplate for ceiling type 3, Permanent ceiling.

Inlet faceplate -03 and -3E (mounted to Munio) for permanent ceiling e.g. gypsum/plaster board.

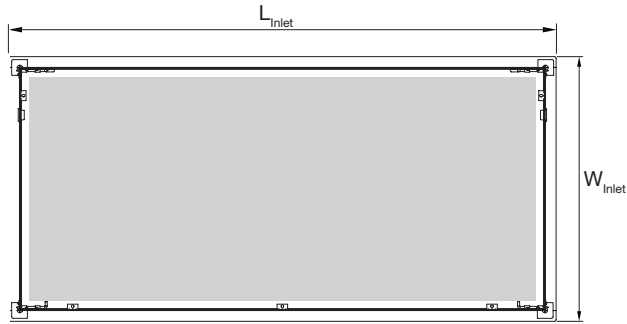

Figure 12. Inlet faceplate -03 dimensions (for -3E check "Installation Instructions").

Separate inlet faceplate for ceiling type 3, Permanent ceiling

Inlet faceplate -3S for separate mounting in permanent ceiling e.g. gypsum/plaster board.

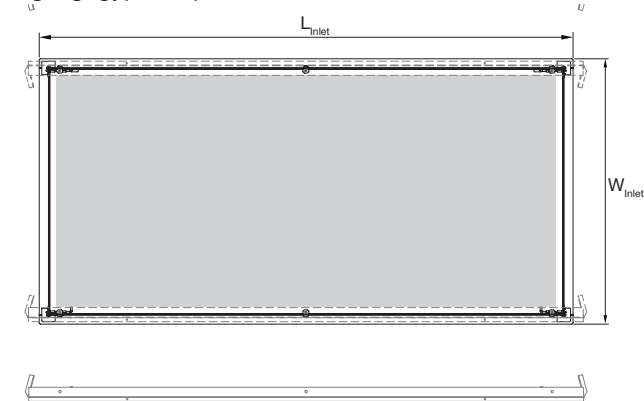

Figure 13. Inlet faceplate -3S dimensions.

Separate inlet faceplate for ceiling type 1 and 21, lay-in ceiling

Inlet faceplate -01 and -21.

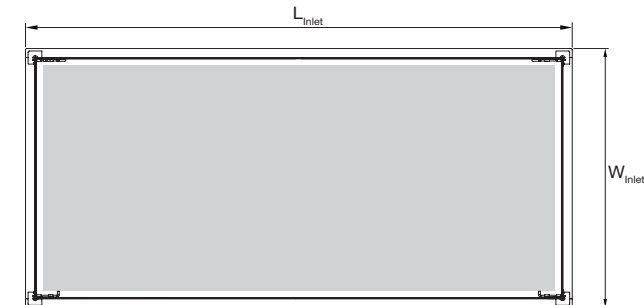

Figure 14. Inlet faceplate -01/-21 dimensions.

For detailed information go to Installation Instruction Munio: www.lindQST.com.

Installation sketch for Munio with inlet faceplate type -03 and 3E.

Inlet faceplate -3 and -3E (mounted to Munio) for permanent ceiling for example gypsum/plaster board.

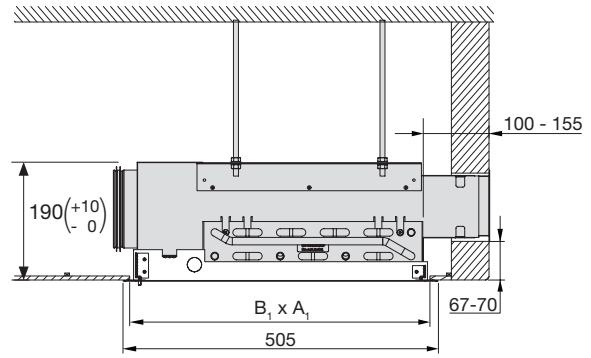

Figure 15. Installation sketch for Inlet faceplate -3 and -3E with cutout dimensions.

Installation sketch for Munio with separate inlet faceplate type -3S

Inlet faceplate -3S for separate mounting in permanent ceiling for example gypsum/plaster board.

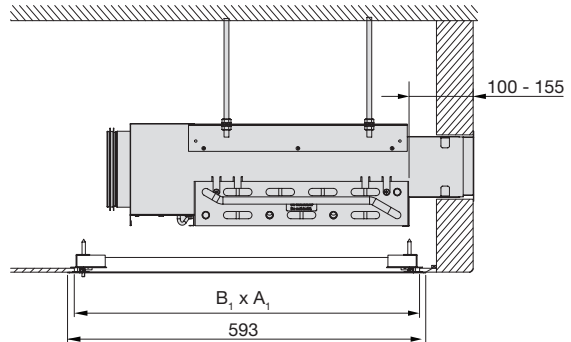

Figure 16. Installation sketch for Inlet faceplate -3S with cutout dimensions.

Installation sketch for Munio with separate inlet faceplate type -01/-21

Inlet faceplate -01/-21 for separate mounting from Munio in a lay-in ceiling T24/T15 (available in 1200 mm only).

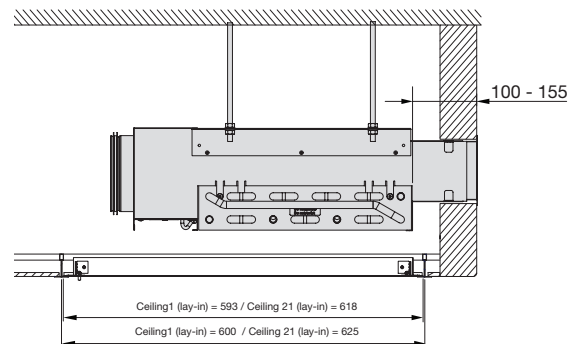

Figure 17. Installation sketch for inlet faceplate -01/-21 with outside dimensions.

Active chilled beam

Munio

LindQST - just a click away

The Lindab Quick Selection Tool, [lindQST®](#), is a very fast, easy-to-use and flexible online tool for your daily work. [Calculate the Munio here](#)



Picture 14. LindQST - Indoor Climate Designer.

LindQST® helps you select the right waterborne products, e. g. active chilled beams, passive radiant chilled beams, radiant cooling- and heating panels and facade units and quickly finds the corresponding documentation.

In *Waterborne Documentation* you can easily find all available product documentation. Always in the latest version.

In *Waterborne Calculator* you can do a professional calculation based on your specific input data to finetune your choice or calculate different variants of the product. Smart warnings point out if a set-up will not work.

In *Waterborne Selector* you can compare the proposed products according to your specific requirements and select the one which fits best to your needs .

Not enough? With *Indoor Climate Designer* you can insert your selected waterborne product into your room and simulate the actual air distribution, optimize the placing in the ceiling taking into account the calculated air velocities and sound levels.

You can at anytime display your selection and calculations graphically. In addition, you can print or save all results and related documents for your documentation (incl. data sheets, dxf-files and room books).

With lindQST® you will easily find the most suitable product for your project.

It provides an easy and quick access to the latest product information, technical specifications and assembly instructions on the Internet, making it the ideal tool installers, consultants and architects alike.

www.LindQST.com

- Fast product selection waterborne products in accordance to Eurovent (chilled beams and facade units).
- Easy access to all current documentation.
- Fast design of waterborne products.
- Indoor Climate Designer: Graphical representation of the spatial situation in 2D / 3D and floor plans from AutoCAD®.
- Calculation of capacities, sound power levels, pressure losses and flow conditions.
- 3D particles or smoke show the air distribution in the room.
- Diagram showing the time course of the CO₂ concentration in the room.
- Room book generation and data sheet for individual rooms and outlets or entire projects.
- Project can be saved and exchanged in its own project area.



Active chilled beam

Munio

Munio & Lindab Safe Click

Munio is equipped with Lindab Safe Click as a standard, which makes the usage of a screw or pop rivet unnecessary, and facilitates a fast installation of the units.



Program text

The rectangular active chilled beam Munio can be used for cooling heating and ventilation. Munio has standard 4-pipe connection and can be installed and integrated into bulkheads for example in hotel-, in hospital- or for any other rooms with bulkheads.

Despite the product's small external dimensions, the construction makes it possible to achieve a high cooling capacity based on the induction principle. Ventilation air is released through the nozzles into a dispersal zone, thereby creating a low static pressure. The low pressure causes the warm air from the room to be induced into the ventilation air through the battery. The volume of the recirculated indoor air is two to five times the ventilation air. The warm room air is cooled as it passes through the battery, which consists of aluminium fins with copper pipes filled with cold, running water. The heat from the room is absorbed through the aluminium fins and then transferred through the copper pipe to the water circuit and goes further to a central cooling unit.

Munio features the Lindab JetCone, an innovative way of regulating the air volume for simplified commissioning. Munio is designed for easy mounting for example with a very low product height, a telescope extension piece with means for easy click in of the recommended outlet front grilles. Munio does not need any filter and works with dry cooling so service & maintenance issues are limited. Munio offers access to all internal parts for inspection and cleaning to fulfil high hygienic requirements.

Lindab's active chilled beams are Eurovent-certified and tested according to EN-15116.

The standard perforated inlet faceplate of Munio is for perfect integration into recessed gypsum ceiling (ceiling type 3), fixed mounted to Munio and guarantee free area for the secondary room air. The faceplate is available as standard, in signal white RAL 9003 or in pure white RAL 9010, gloss value 30. Other RAL colours on request.

Equipped with Lindab's recommended front outlet grille AD21CN-M (or AL21CN-M) adjustment of air distribution profile is possible. The outlet front grille is not included in Munio delivery. We recommend four standard Munio aluminium grilles: AD21CN-M or AL21CN-M.

Water valves, actuators, condensation guard Regula Secura, room controller Regula Combi and connection cards (i.e. Regula Connect) can all optional be integrated into the unit.

Technical Data (Example)*:

Manufacturer:	Lindab
Product:	Munio
Type:	I-1000-12-125-A5, -20-80-03-9003
Length:	1000 mm
Width:	550 mm
Height:	170 mm
Water connection:	12 mm
Connection type:	A5
Supply air amount:	20 l/s
Static nozzle pressure loss:	80 Pa
Inlet faceplate type:	03
Colour:	RAL 9003, gloss 30
Amount:	2 pieces
Water temperatures cooling in/out:	14 / 17°C
Room temperature:	25°C
Water connection:	12 mm
Water flow rate:	0.0544 l/s
Pipe pressure drop loss:	10.0 kPa
Cooling capacity/beam:	854 W
Induction ratio:	3.6
Sound power level:	25 dB(A)

*For correct update of your program text find "Waterborne Calculator" on: www.lindQST.com.

Order code

Product Munio I- 1200- 12- 125- A5- 100 25 03 9003

Type								
Product length: 800, 1000, 1200, 1400 mm								
Water connections: 12 mm								
Air connection: 125 mm								
Connection type: A5/A6								
Static nozzle pressure: 30-120 Pa								
Air volume: 3-50 l/s (depends on length!)								
00 = without inlet faceplate								
01 = faceplate for ceiling type 1*								
03 = faceplate for ceiling type 3								
3E = type 3 with extra access								
3S = type 3 for separate installation*								
21 = faceplate for ceiling type 21*								
0000 = without inlet faceplate								
9003 = faceplate RAL 9003								
9010 = faceplate RAL 9010								

*one size fit all!

Order example - outlet front grilles

Product	AD21CN-M	aaa	bbb	cccc
Type				
L - measure				
H - measure				
Grilles standard finish				
--- Anodized aluminium				
9010 RAL 9010, Gloss 30				
9003 RAL 9003, Gloss 30				
xxxx On request, other RAL-colour				



Most of us spend the majority of our time indoors. Indoor climate is crucial to how we feel, how productive we are and if we stay healthy.

We at Lindab have therefore made it our most important objective to contribute to an indoor climate that improves people's lives. We do this by developing energy-efficient ventilation solutions and durable building products. We also aim to contribute to a better climate for our planet by working in a way that is sustainable for both people and the environment.

[Lindab](#) | For a better climate