

Fresh air valve

ULV

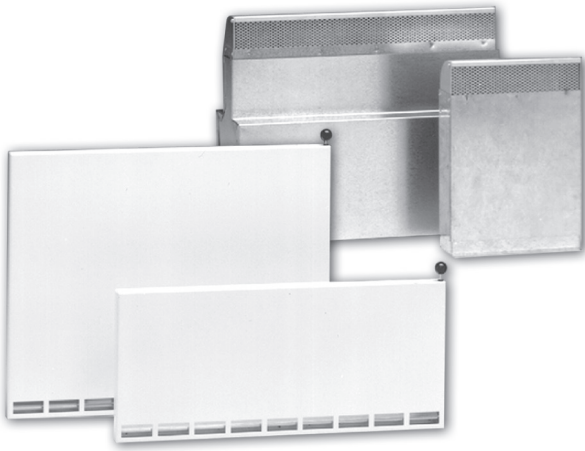

Description

ULV is a rectangular fresh air valve for installation in external walls behind radiators. The valve is equipped with a damper that is opened and closed by means of a handle on the top. In order to achieve a good seal against the wall, the back of the valve is equipped with a sealing strip made of synthetic foam rubber. Three telescopic wall sleeve are available as accessories to the valves, including the sound-attenuated version. The valve can also be supplied with an extended damper arm. ULV is used for the intake of fresh air in connection with a mechanical exhaust system, whereby good utilisation of air jet and convection heat is achieved. ULV is typically used in homes and premises where there are requirements for a solution that is simple and economical to install. Valve type ULV2 should be selected where maximum heating is required.

- Excellent utilisation of air jet and convection heating.
- Fits wall thicknesses from 230 mm to 440 mm
- Can be supplied with sound-insulated telescope
- Wall sleeve in brick dimensions

Maintenance

The front panel can be removed from the wall rail to make cleaning possible. The visible parts of the diffuser can be wiped with a damp cloth.

Order code

Product	ULV	a	b
Type			
Height			

Accessories:

Without accessories	0
Telescopic wall sleeve 230 mm	1
Telescopic wall sleeve 470 mm	2
Sound-attenuated telescopic wall sleeve	3

Dimension

ULV-1

Weight 1.9 kg

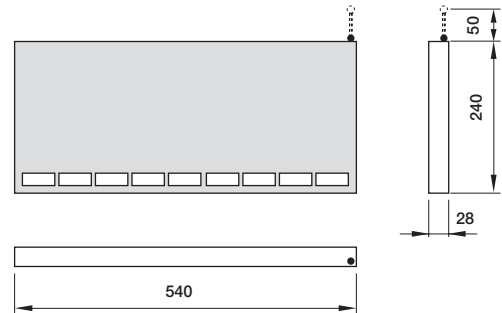

ULV-2

Weight 3.2 kg

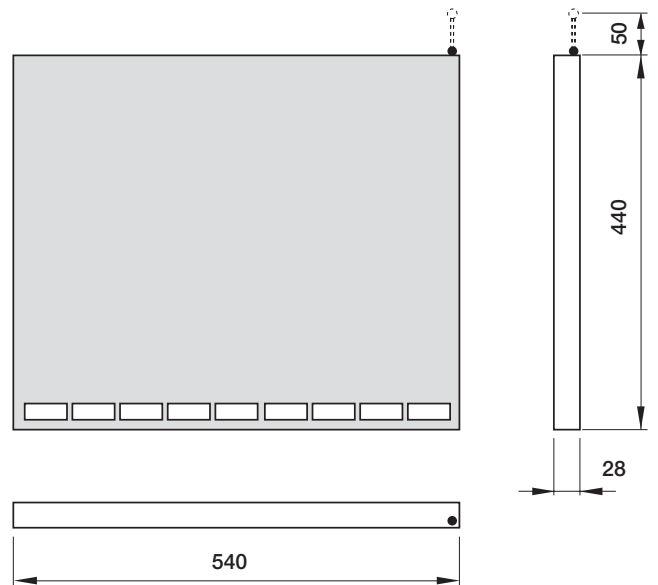

Materials and finish

- Valve: Galvanised steel plate with aluminium damper.
- Wall sleeve: Galvanised steel plate with aluminium insert.
- Sound insulation: Melamine foam plastic
- Standard colour: Powder-coated RAL 9010 white

ULV is also available in stainless steel. Please contact Lindab's sales department for further information.

Fresh air valve

ULV

Mounting

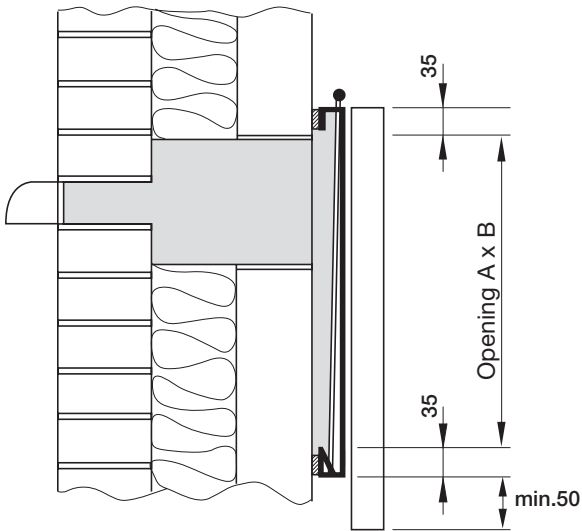

The accompanying installation rail should be fastened to the wall. The fresh air valve is suspended from the rail and fastened to it by means of screws through the lower edge of the front plate.

	A mm	B mm
ULV-1	170	510
ULV-2	370	510

Width of wall sleeve:

230 mm corresponds to one brick.
470 mm corresponds to two bricks.

Accessories

- 1) Telescopic wall sleeve
Width 230 mm. Weight 2.0 kg

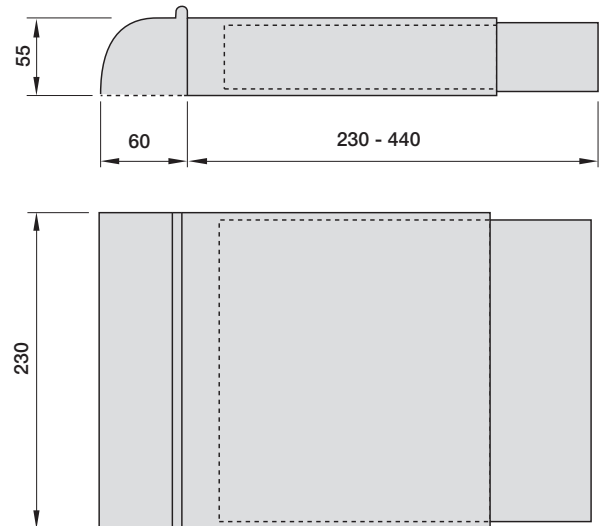

- 2) Telescopic wall sleeve
Width 470 mm. Weight 3.8 kg

- 3) Sound-attenuated telescopic wall sleeve
Weight: 4.7 kg

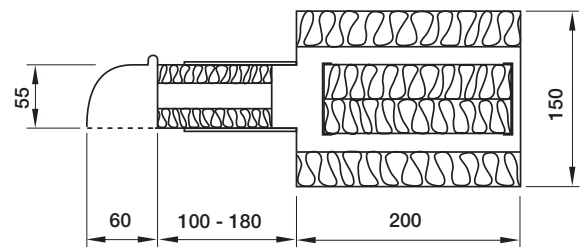

Extended damper arm.

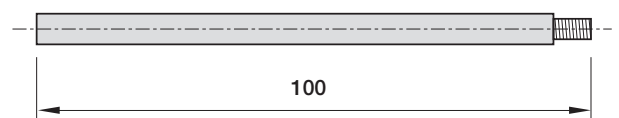

Fresh air valve

ULV

Technical data

Capacity

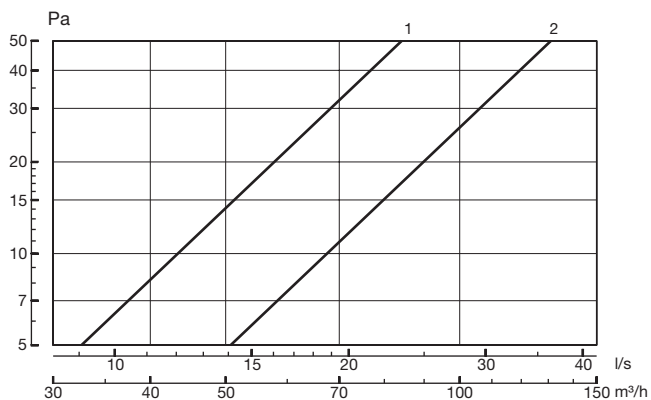

1. ULV with wall sleeve type 1.
2. ULV with wall sleeve types 2 and 3.

Sound reduction

ULV with wall sleeve type 3

Weighted element-normalised level difference

$D_{n,e,w} = 48 \text{ dB}$, $\Delta_{\text{max}} = 8.6 \text{ dB}$

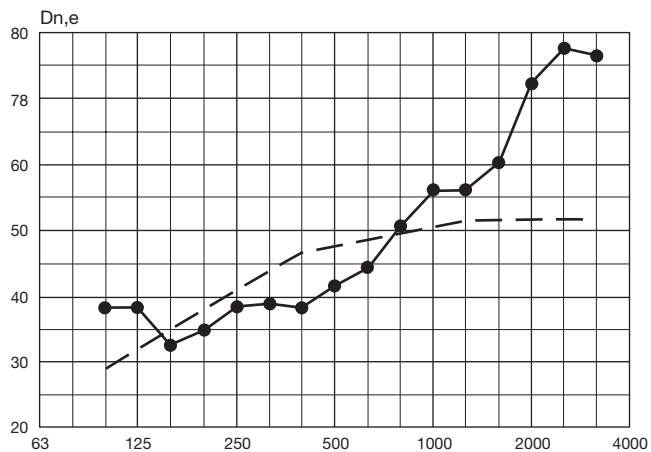

The sound insulation measurements were undertaken by DELTA & Vibration, in accordance with the testing instructions in DS/ISO 140-3:1978.