



# Lindab **Ultra BT™** Room Control System

Commissioning instruction

# UltraLink®

# Ultra BT™

## Content

- 1.0 System overview ..... 3
  - 1.1 Introduction ..... 3
  - 1.2 System features ..... 3
  - 1.3 Set up overview ..... 3
  - 1.4 Download applications ..... 3
  - 1.5 Wireless sensors ..... 4
  - 1.6 Room regulation ..... 4
  - 1.7 Presence regulation ..... 4
  - 1.8 Temperature, CO<sub>2</sub> and humidity regulation ..... 5
  - 1.9 Signal for controlling heating and cooling sources ..... 5
  - 1.10 Airflow regulation ..... 5
  - 1.11 Firmware update ..... 5
- 2.0 Change control settings to UltraLinks ..... 6
- 3.0 Pairing instructions ..... 7
  - 3.1 Pairing of presence, temperature, relative humidity and/or CO<sub>2</sub> sensor to supply UltraLink. .... 7
  - 3.2 Pairing UltraLink to UltraLink ..... 8
  - 3.3 If sensor doesn't connect ..... 10
- 4.0 Enable room regulation ..... 10
  - 4.1 Assign control variables for your system. .... 10
  - 4.2 Temperature control ..... 11
  - 4.3 CO<sub>2</sub> control ..... 11
  - 4.4 Relative humidity control ..... 12
  - 4.5 Presence control ..... 12
  - 4.6 Airflow control ..... 13
- 5.0 Set UltraLink to control heating and cooling sources via analog signal ..... 14
  - 5.1 Run cable between UltraLink and heating/cooling source ..... 14
  - 5.2 Make settings to analog output signal inside OneLink app ..... 14
  - 5.3 Disable increased airflow when heating/cooling ..... 15
- 6.0 Give the end user control to adjust the room climate ..... 15
  - 6.1 Generate QR-codes associated to different rooms in the commissioning app OneLink™ ..... 15
- 7.0 End-user app OneSet™ ..... 16

# UltraLink®

# Ultra BT™

## 1.0 System overview

### 1.1 Introduction

Ultra BT room control system is compatible with Lindab Bluetooth sensors and UltraLinks type 4. You can read the type number on the product label.

This commissioning instruction describes the features and the commissioning steps of the Ultra BT room control system that is related to wireless sensors and airflow control based on the sensor readings.

The setup and configuration of sensors and room regulation is done in Lindab OneLink application via smartphone.

The room comfort can be adjusted by the room visitor via Lindab OneSet application via smartphone.

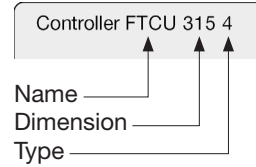

### 1.2 System features

Ultra BT room control system contains of at least one supply UltraLink unit, up to 5 different sensors (regulation types) and one extract UltraLink.

### 1.3 Set up overview

1. Change control settings to UltraLinks
2. Pairing sensor to supply UltraLink
3. Pairing supply UltraLink to extract UltraLink
4. Enable room regulation

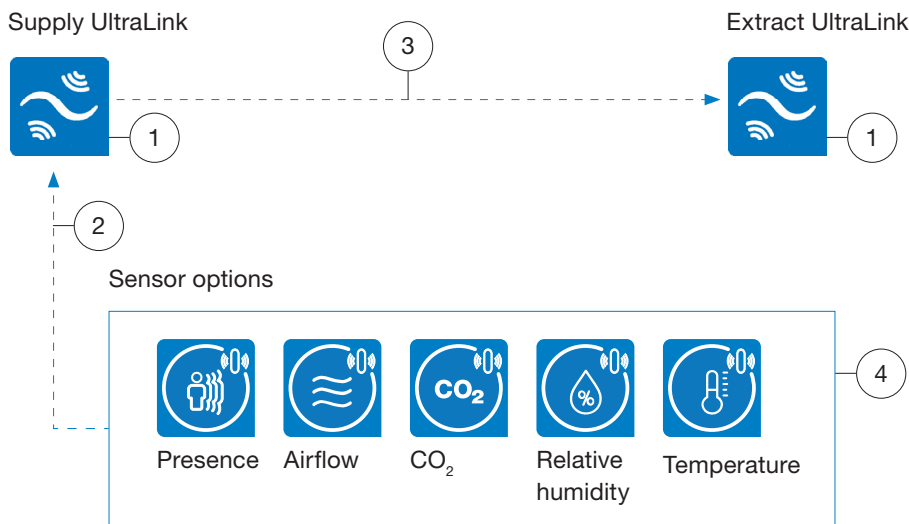

### 1.4 Download applications

Commissioning application - Lindab OneLink™  
End user application - Lindab OneSet™

Commissioning application

End user application



OneLink™



OneSet™



# UltraLink®

# Ultra BT™

## 1.5 Wireless sensors

Up to five wireless sensors can be connected to one UltraLink using a smart device and the Lindab OneLink app. After successful pairing of a sensor, its readings are available both in the app but also in the registers where they are accessed under the following modbus registers:

Register	Reading	
3x2012	Presence	Sum
3x2021	Temperature	Min
3x2022		Max
3x2023		Average
3x2034	Airflow	Sum
3x2041	Humidity	Min
3x2042		Max
3x2043		Average
3x2051	CO <sub>2</sub>	Min
3x2052		Max
3x2053		Average

If you connect more than one sensor that reports the same variable type (for example two temperature sensors) then you can choose to read either the max, min or average value according to the table above.

## 1.6 Room regulation

The regulation will not strive to always reach a given set point. It will maintain the climate within the allowed deviation that is configured.

It can only maintain a climate where the supply air has the possibility to support it. It means that it can not give a

lower temperature than the temperature in the supply air, if not connected to any cooling source.

The room regulation works by applying a multiplication factor to the normal flow.

As long as the regulation is within its deadband the regulation factor is 1.0. As soon as it move outside the deadband a multiplication factor is applied to the normal flow - meaning that the flow will increase. Before the system applies to the factor a check is automatically made to make sure that an increase of the flow actually improves the conditions. It will for example not increase the flow if the indoor temperature is too low and the supply air temperature is even lower.

## 1.7 Presence regulation

The multiplication factor from presence is always used when the room is unoccupied and it either overrides the other factors (Economy mode) or it is multiplied with the highest factor from the other regulation types (Comfort mode).

When the room is occupied its factor is treated just like the factor from temperature, CO<sub>2</sub> and humidity and will only be used if it is the highest among the enabled regulation types.

The graph below (graph 1) shows the global set point factor that will be used in a case where regulation is active for all of the four regulation types mentioned above. Each regulation type is producing its own multiplication factor and at any given moment the highest of them will be used (as long as the room is occupied). The red areas shows the effect you get by activating Comfort mode.

Graph 1

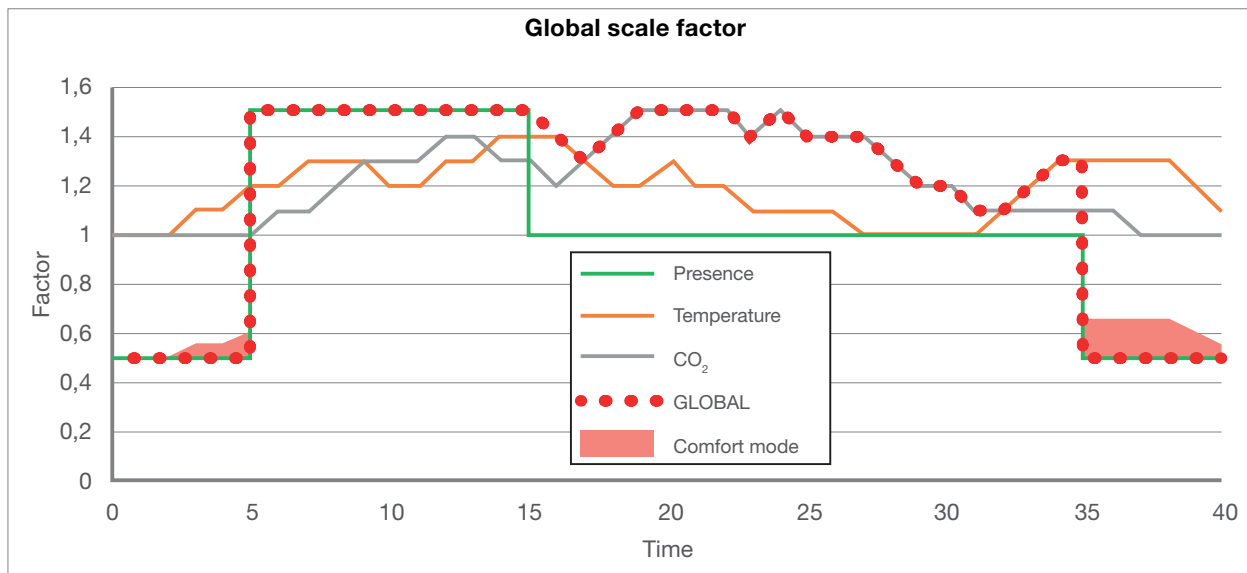

UltraLink®

Ultra BT™

### 1.8 Temperature, CO<sub>2</sub> and humidity regulation

Each regulation type that is used for the room regulation will produce its own multiplication factor. The system will always be governed by the regulation type and the multiplication factor that demands the highest amount of air.

### 1.9 Signal for controlling heating and cooling sources

Control of heating and cooling sources can be added using analog signals from the UltraLink. The signals on the analog ports AO1 and AO2 can be configured for heating and/or cooling using the OneLink app. If heating and/or cooling is enabled on the analog ports, the same control curve that controls the temperature by air is used, but with one important difference. The max scale factor used to calculate the signal is always 100% and the minimum factor is 0%. This means that the proportional regulation on the analog ports will always vary between 0-100%. The percentage is converted to the corresponding voltage level based on what type of control signal we have specified when configuring the analog ports (0-10V, 2-10V, 10-0V or 10-2V). The analog signals can be used for any passive heating or cooling source with an analogue actuator.

The UltraLink has a smart programming which prohibits both heating and cooling at the same time.

### 1.10 Airflow regulation

When regulation on airflow is used all other regulation types are deactivated. It can only be used alone. In this case the product will act as a slave to other airflow sensors of type FTMU or FTCU.

### 1.11 Firmware update

By regularly searching for and carrying out firmware upgrades, you ensure optimal performance and the latest functionality of your UltraLink.

#### How to upgrade your firmware

1. Open OneLink app and log in to UltraLink
2. Go to "Configuration" > "Device info"
3. Click on "Firmware update"

# UltraLink<sup>®</sup>

# Ultra BT<sup>™</sup>

## 2.0 Change control settings to UltraLinks

2.1 Open OneLink application.

2.2 Scan for devices and connect to UltraLink.

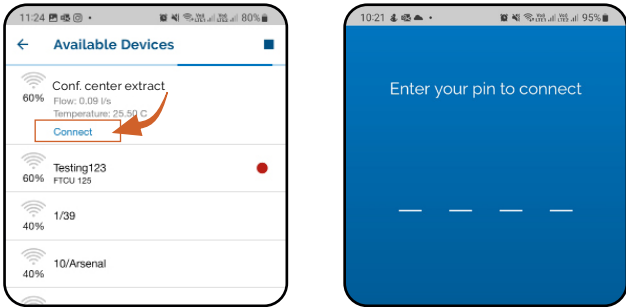

Standard PIN: 1111

2.3 Go to "Configuration".

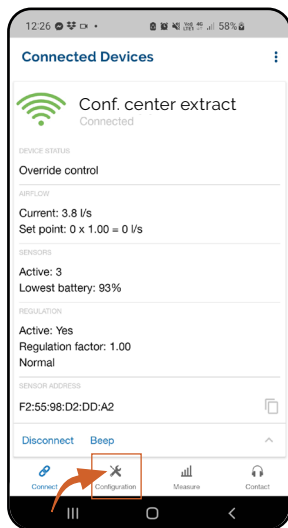

2.4 Go to "Device settings".

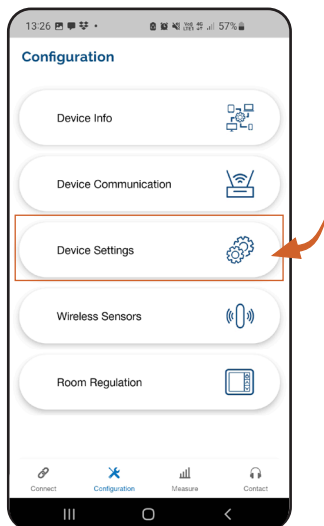

2.5 Change the control settings from "Analog" to "Bus".

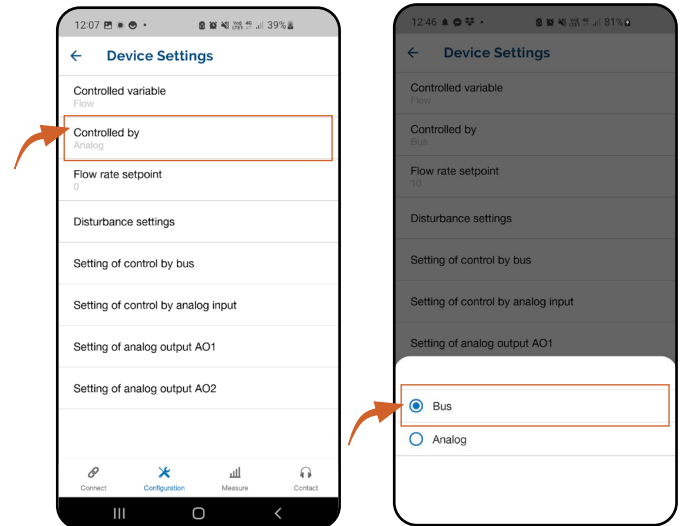

2.6 Set flow rate set point.

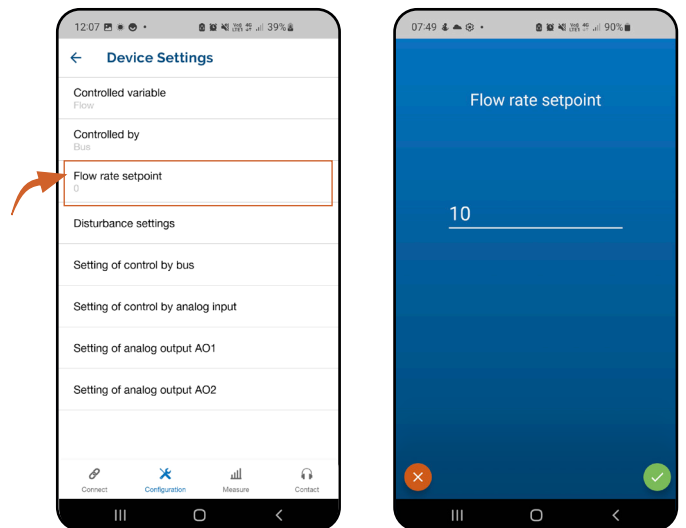

# UltraLink®

# Ultra BT™

## 3.0 Pairing instructions

### 3.1 Pairing of presence, temperature, relative humidity and/or CO<sub>2</sub> sensor to supply UltraLink.

- 3.1.1 Turn on sensor according to specific sensor instruction.
- 3.1.2 Open OneLink application.
- 3.1.3 Scan for devices and connect to supply UltraLink.

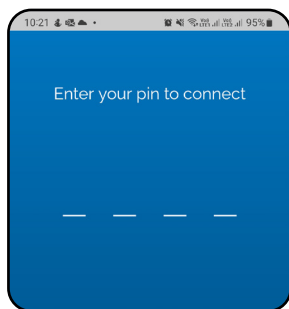
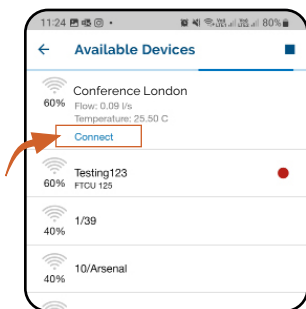

Standard PIN: 1111

### 3.1.4 Go to "Configuration"

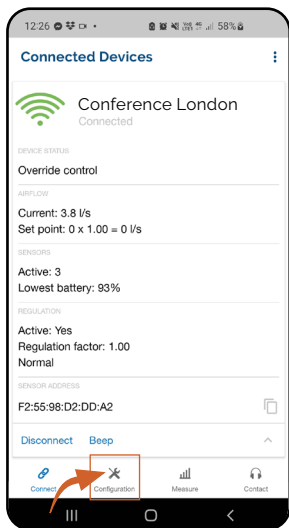

### 3.1.5 Go to "Wireless sensors".

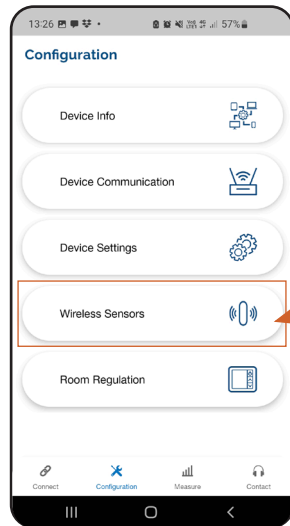

### 3.1.6 Tap on one of the available (grey colored) sensor slots.

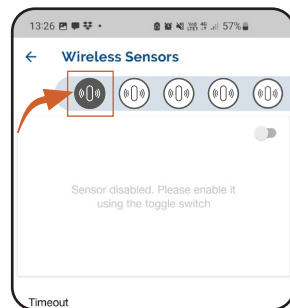

### 3.1.7 Click on "MAC address" and scan the QR-code attached to your sensor.

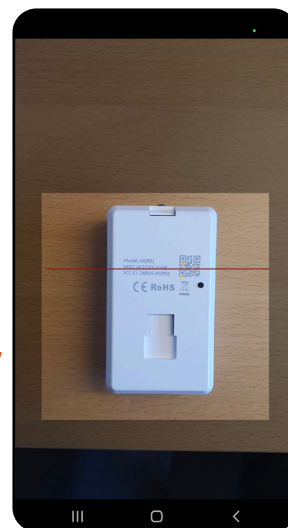
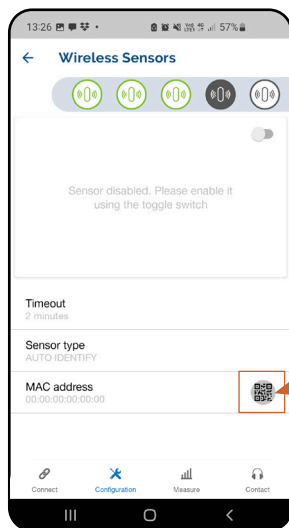

# UltraLink®

# Ultra BT™

If the sensor is not available for pairing - please make sure you have the latest firmware update. See ["1.11 Firmware update" on page 5](#)

### 3.1.8 Click on enable sensor.

Wait for the sensor to connect. When the sensor icon turns green, it's connected. This might take a few seconds.

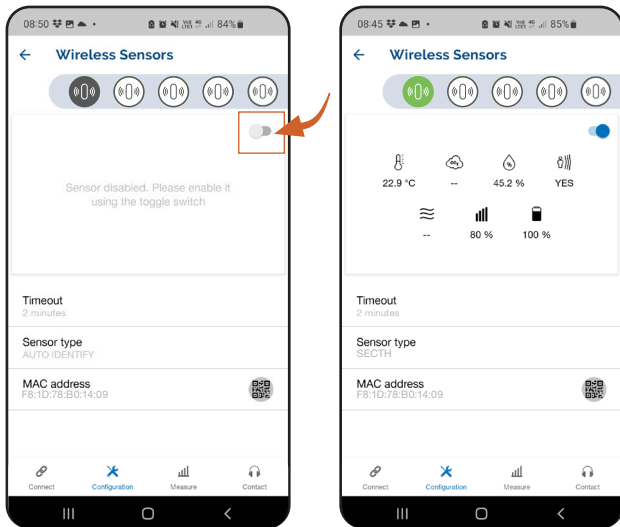

- OK
- Error → Go to ["3.3 If sensor doesn't connect"](#)
- Waiting
- Inactive

## 3.2 Pairing UltraLink to UltraLink

To complete the commissioning of the Ultra BT room control system you need to pair the supply UltraLink to the extract UltraLink so that the extract UltraLink acts as slave to the supply UltraLink.

If you wish to use the extract UltraLink as sensor to the supply UltraLink to read airflow or temperature, you need to pair the extract UltraLink as sensor to the supply UltraLink.

The steps in this paragraph describes the pairing steps.

### 3.2.1 Open OneLink application.

### 3.2.2 Scan for devices and connect to your UltraLink.

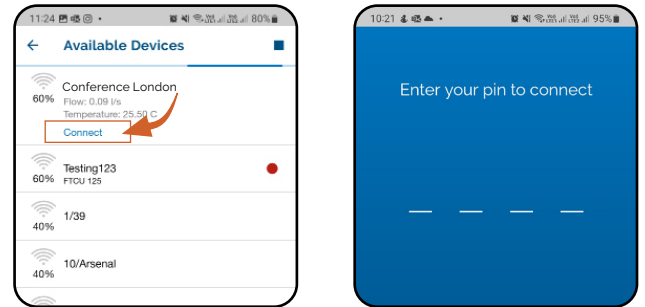

Standard PIN: 1111

### 3.2.3 Copy the UltraLink MAC address.

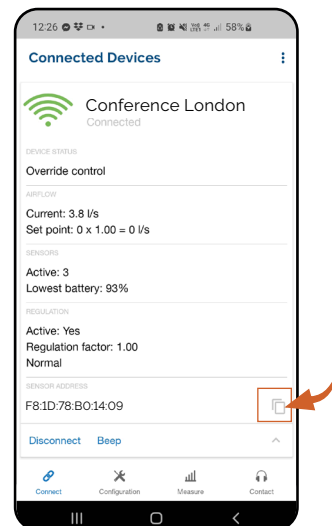

### 3.2.4 Disconnect UltraLink.

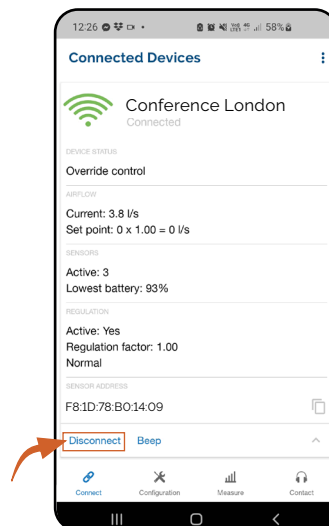



# UltraLink®

# Ultra BT™

3.2.5 Scan for devices again and connect to the other UltraLink.

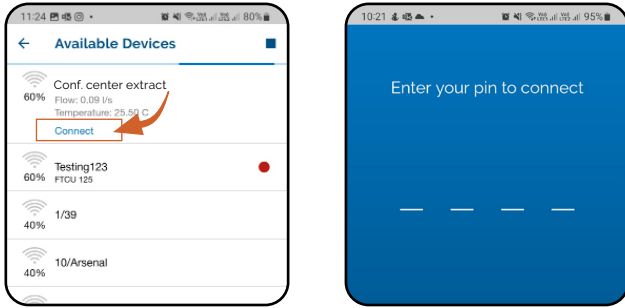

Default PIN: 1111

3.2.6 Go to "Configuration".

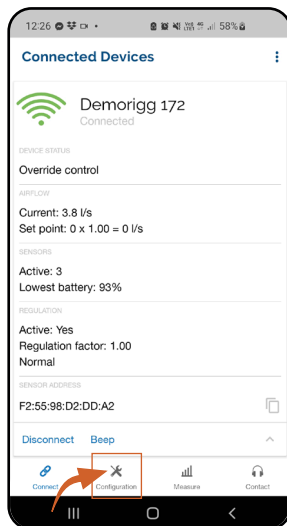

3.2.7 Go to "Wireless sensors".

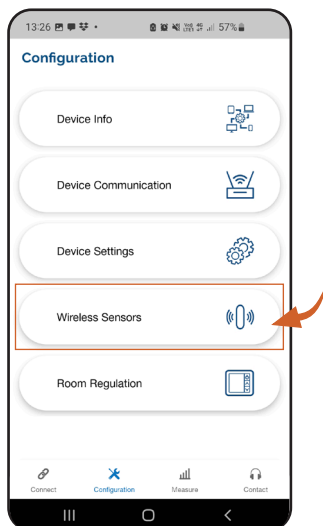

3.2.8 Tap on one of the available (grey colored) sensor slots.

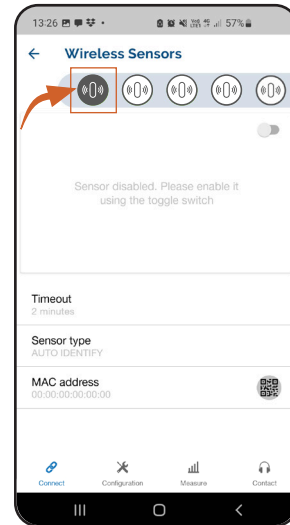

3.2.9 Click on "MAC address" and paste the copied UltraLink MAC-address.

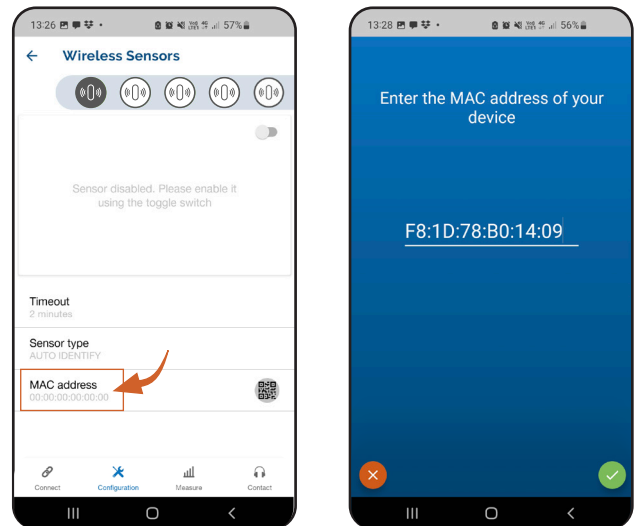

# UltraLink<sup>®</sup>

# Ultra BT<sup>™</sup>

### 3.2.10 Click on enable sensor.

Wait for the sensor to connect. When the sensor icon turns green, it's connected. This might take a few seconds.

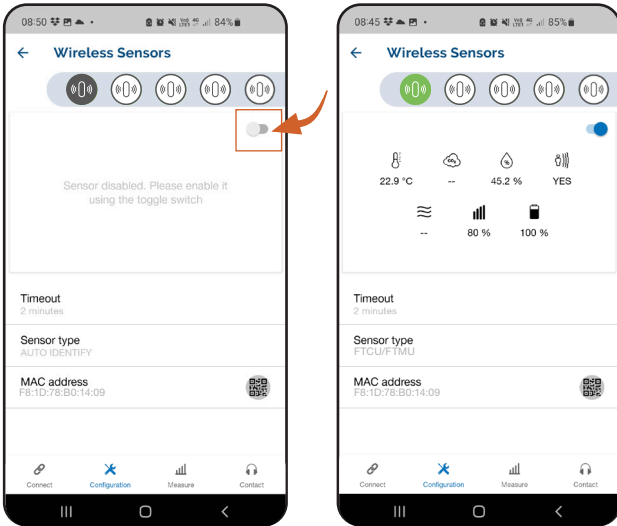

- OK
- Error → Go to ["3.3 If sensor doesn't connect"](#) on page 10
- Waiting
- Inactive

### 3.3 If sensor doesn't connect

3.3.1 Check the sensor battery.

3.3.2 Check that the distance between the sensor and the UltraLink doesn't exceed maximum bluetooth range.

You can find the maximum distance value and other requirements for your specific sensor in the sensor data sheet.

[Link to sensor documentation >>](#)

## 4.0 Enable room regulation

### 4.1 Assign control variables for your system.

4.1.1 Open OneLink application.

4.1.2 Scan for devices and connect to the supply UltraLink.

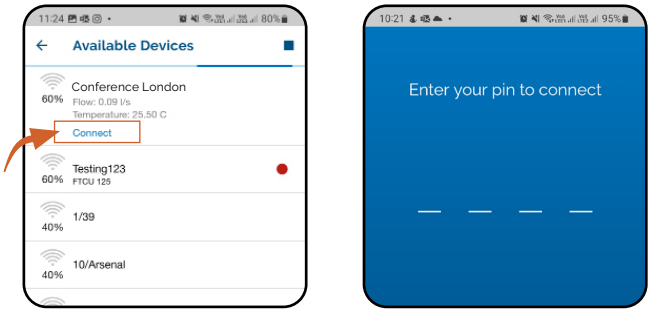

Standard PIN: 1111

4.1.3 Go to "Configuration".

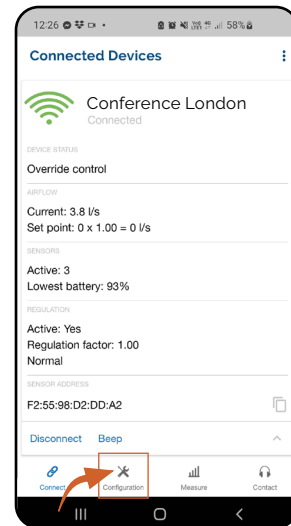

4.1.4 Go to "Room Regulation".

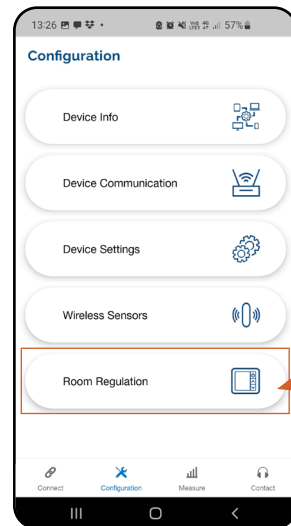

# UltraLink®

# Ultra BT™

4.1.5 The top bar represents the different variables which you can use to control your room/zone.

### Regulation types:

-  Temperature
-  CO<sub>2</sub>
-  Relative humidity
-  Presence
-  Airflow

### Status light:

-  Working
-  Stand by
-  Not available
-  Inactive

## 4.2 Temperature control



**Detailed information**

**Reset values to default**

**Toggle graph (% / l/s)**

**Graph**

- Off** - no regulation on temperature
- Min** - regulate according to minimum value
- Max** - regulate according to max temperature value reported from configured temperature sensor
- Avg** - regulate according to average value

**Control variable**  
Avg

**Baseline** 22 °C

**Allowed deviation** 1 °C

**Dead band** 50 %

**Scale factor** 270 %

**Target temperature**

**Allowed deviation +/- from Baseline**

**How much the control value can deviate from Baseline before regulation starts**

**Maximum factor for multiplication with the normal airflow set point of the UltraLink when temperature value is outside of allowed deviation.**

## 4.3 CO<sub>2</sub> control

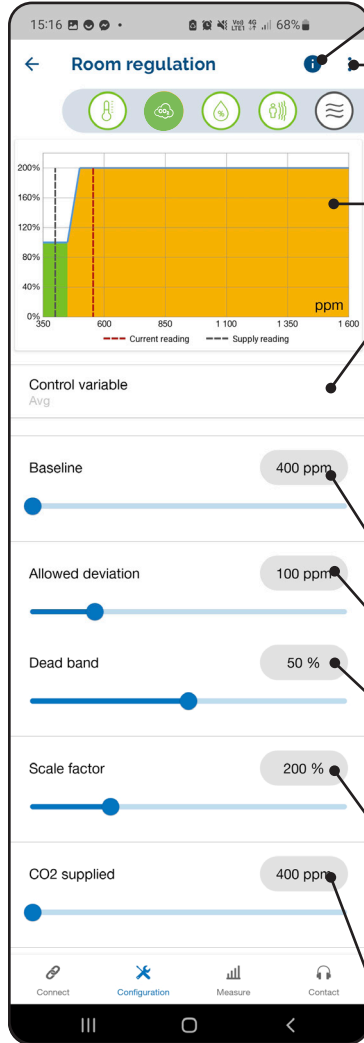

**Detailed information**

**Reset values to default**

**Toggle graph (% / l/s)**

**Graph**

- Off** - no regulation on CO<sub>2</sub>
- Min** - regulate according to minimum value
- Max** - regulate according to max CO<sub>2</sub> value reported from configured CO<sub>2</sub> sensor
- Avg** - regulate according to average value

**Control variable**  
Avg

**Baseline** 400 ppm

**Allowed deviation** 100 ppm

**Dead band** 50 %

**Scale factor** 200 %

**CO<sub>2</sub> supplied** 400 ppm

**Target CO<sub>2</sub> value**

**Allowed deviation +/- from Baseline**

**How much the control value can deviate from Baseline before regulation starts**

**Maximum factor for multiplication with the normal flow set point of the UltraLink when CO<sub>2</sub> value is outside of allowed deviation.**

**Estimated value of supply air\*.**

\* Since the UltraLink has no CO<sub>2</sub> measurement we need to add an estimated value to the supply air. This estimate will be the comparison to the value registered from the sensor in the room and will determine if the multiplication factor will be applied or not.

Typical CO<sub>2</sub> value for outdoor air is 400 ppm.

# UltraLink®

## 4.4 Relative humidity control

**Detailed information**

**Reset values to default**

**Toggle graph (% / l/s)**

**Graph**

**Off** - no regulation on relative humidity

**Min** - regulate according to minimum value

**Max** - regulate according to max relative humidity value reported from configured relative humidity sensor

**Avg** - regulate according to average value

**Target relative humidity value**

**Allowed deviation +/- from Baseline**

**How much the control value can deviate from Baseline before regulation starts**

**Scale factor is multiplied with the normal flow set point for the UltraLink when relative humidity value is outside of allowed deviation.**

**Estimated value of supply air\*.**

\* Since the UltraLink has no relative humidity measurement we need to add an estimated value to the supply air. This estimation will be the comparison to the value registered from the sensor in the room and will determine if the multiplication factor will be applied or not.

# Ultra BT™

## 4.5 Presence control

**Detailed information**

**Reset values to default**

**Toggle graph (% / l/s)**

**Graph**

**On** - regulate on presence

**Off** - turn off presence regulation

**Time before starting forced airflow from first presence indication and time before reduced airflow from last presence indication**

**Multiplication factor for when the rooms is occupied**

**Multiplication factor for when the rooms is unoccupied**

**On** - allows a reduced presence regulation and also regulate from temperature, CO<sub>2</sub> and relative humidity values to maintain a comfortable climate.

**Off** - Only regulate from presence regulation settings

4.6 Airflow control

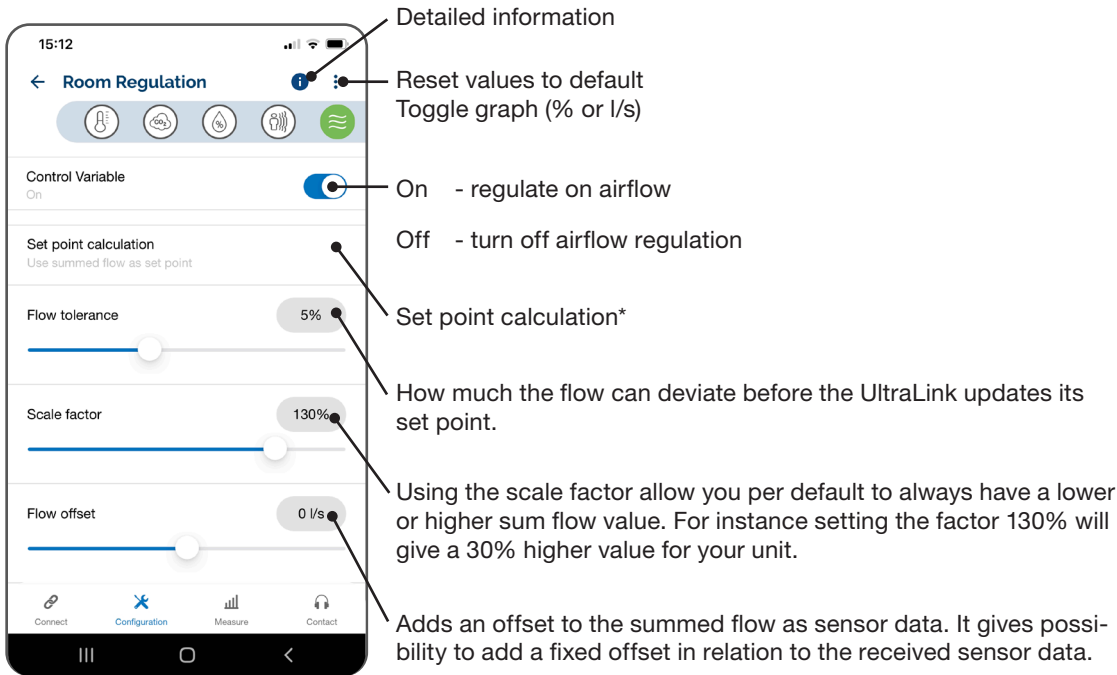

\* Set point calculation settings

<p>Use summed airflow as set point</p>	<p>With this selection enabled the set point for the product will be calculated as the sum of the flows that are received as sensor data multiplied by the “Scale factor” and with “Flow offset” added.</p> <p>New set point = (UltraLink sensor 1 + UltraLink sensor 2 + ...) x Scale factor + Flow offset</p>
<p>Reduce products set point with summed airflow</p>	<p>With this selection enabled the set point that will be used corresponds to the products own set point reduced by the summed flows that are received as sensor data multiplied by the “Scale factor” and with “Flow offset” added.</p> <p>New setpoint = (Setpoint – (UltraLink sensor 1 + UltraLink sensor 2...)) x Scale factor + Flow offset</p>
<p>Add summed airflow to products set point</p>	<p>With this selection enabled the set point that will be used corresponds to the products own set point added with the summed flows that are received as sensor data multiplied by the “Scale factor” and with “Flow offset” added.</p> <p>New setpoint = (Setpoint +(UltraLink sensor 1 + UltraLink sensor 2...)) x Scale factor + Flow offset</p>



# UltraLink<sup>®</sup>

# Ultra BT<sup>™</sup>

## 5.0 Set UltraLink to control heating and cooling sources via analog signal

### 5.1 Run cable between UltraLink and heating/cooling source

- 5.1.1 Cut the power supply to the UltraLink.
- 5.1.2 Install analog actuator onto the heating/cooling source
- 5.1.3 Run cable between actuator and UltraLink AO1 or AO2

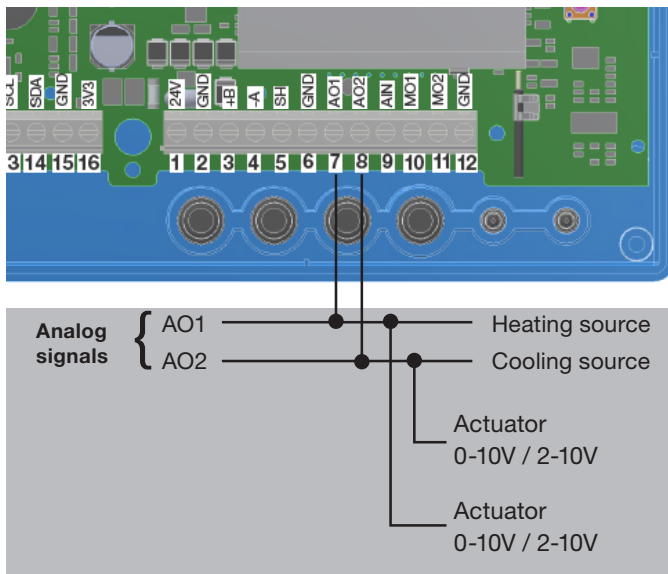

5.1.4 Restore the power supply to the UltraLink and turn it on.

### 5.2 Make settings to analog output signal inside One-Link app

5.2.1 Inside OneLink app; Go to "Configuration".

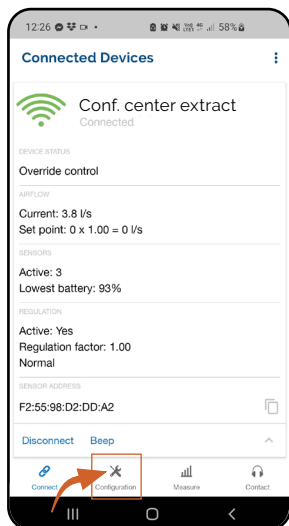

5.2.2 Go to "Device settings".

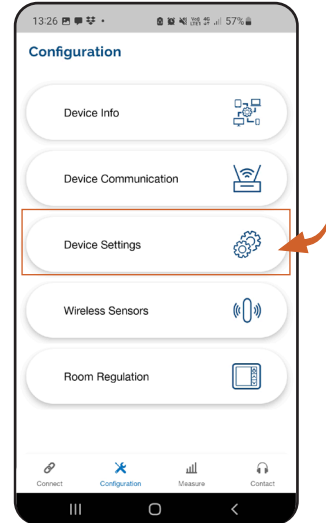

5.2.3 Go to "Setting of analog output AO1"/"AO2"

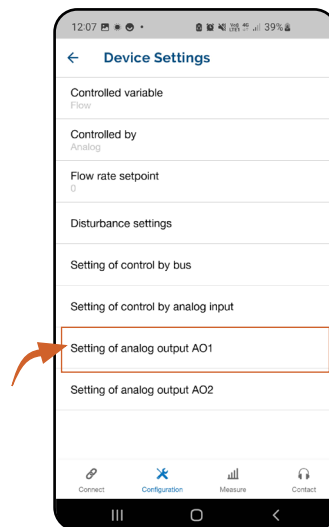

# UltraLink®

# Ultra BT™

### 5.2.4 Click on "Variable" and select "cooling" or "heating"

If you are not able to select cooling or heating as analog output, you need to do a firmware update to your UltraLink. See ["1.11 Firmware update" on page 5.](#)

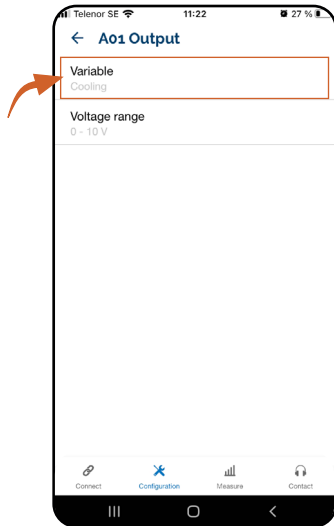

### 5.2.5 Click on "Voltage range" and select the voltage range according to the actuator.

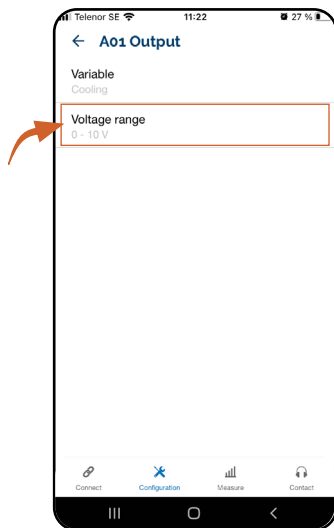

To enable additional heating and/or cooling steering the following steps are also mandatory:

- **Pairing temperatur sensor to supply UltraLink.**

You can choose to read the room temperature via wireless sensor placed in the room, or via the extract UltraLink.

To read temperature via wireless room sensor, see paragraph (["3.1 Pairing of presence, temperature, relative humidity and/or CO<sub>2</sub> sensor to supply UltraLink." on page 7.](#)

To read temperature via extract UltraLink, see paragraph: ["3.2 Pairing UltraLink to UltraLink" on page 8.](#)

- **Enable room regulation via temperature, see paragraph: ["4.2 Temperature control" on page 11](#)**

### 5.3 Disable increased airflow when heating/cooling

If your setup is based on disabling increased airflow when heating/cooling you need to set the "Max scale factor" for temperature control to 100%. By doing so, the temperature will be adjusted using only the heating/cooling source.

## 6.0 Give the end user control to adjust the room climate

The end user may control the room temperature via Lindab OneSet application.

To get access for controlling the room the end user need to scan a QR-code connected to the room (generated from commissioning app OneLink).

### 6.1 Generate QR-codes associated to different rooms in the comissioning app OneLink™

The QR codes are generated in the commissioning app OneLink.

#### 6.1.1 Go to "Configuration > Device info"

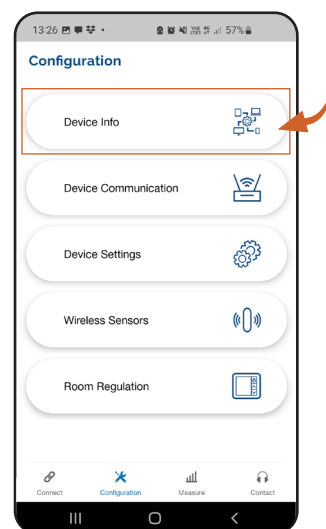

# UltraLink®

# Ultra BT™

### 6.1.2 Go to "End user application access"

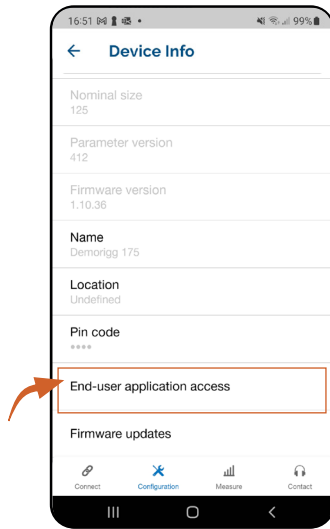

### 6.1.3 Fill in end-user permissions and generate QR code.

The QR code can be generated with different access permissions (read only or read and write) and different duration of validity. This feature allows for flexibility and you can, for example, generate 24h codes for hotel rooms, but in a residential application you can generate codes that gives eternal access.

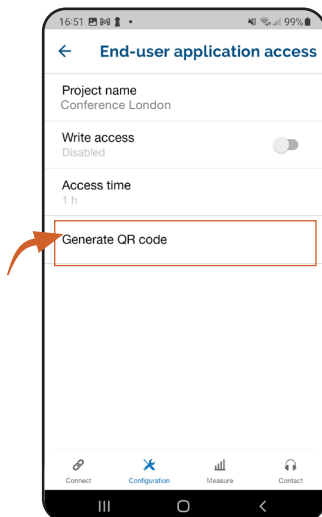

### 6.1.4 Save to phone gallery by clicking "Save to gallery".



When everything is set up for use, download the end-user app OneSet for easy control of the temperature in the room. The OneSet app can replace a traditional wall mounted room controller.

## 7.0 End-user app OneSet™

Ultra BT comes with an optional end-user app where it is possible to monitor the room and make some personal settings, for example room temperature. To be able to access the specific room control settings from this end-user app, you can easy scan the QR-code associated with the room you want to control.

The code is created via the commissioning application One-Link. See chapter ["6.0 Give the end user control to adjust the room climate" on page 15](#)

As soon as a QR-code is scanned, access- duration- and validity rights to the specific room is stored locally in the app. As long as you have right to access the room control settings, all stored rooms will appear in a list view in the OneSet end-user app. Access to these rooms can now be made without need of scanning the code again until the duration rights has exceeded. As soon as the duration is exceeded the room will be removed from the list view and you need to scan the code again to get new access.

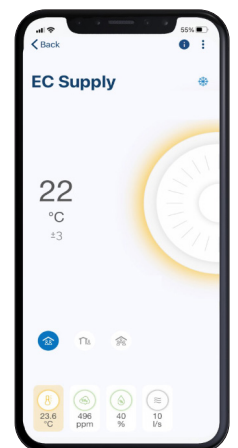



Most of us spend the majority of our time indoors. Indoor climate is crucial to how we feel, how productive we are and if we stay healthy.

We at Lindab have therefore made it our most important objective to contribute to an indoor climate that improves people's lives. We do this by developing energy-efficient ventilation solutions and durable building products. We also aim to contribute to a better climate for our planet by working in a way that is sustainable for both people and the environment.

[Lindab | For a better climate](#)