



## Lindab **LKP (-P)**

Installation instruction - UK  
Installations vejledning - DK  
Montageinstruktion - SE  
ja säätöhjeet - FI  
Montageanleitung - DE  
Istruzioni di montaggio - IT  
Instructions de montage - FR  
Montážní návod - CZ



# Integra

# LKP

## Contents

- Indhold
- Innehållsförteckning
- Sisällysluettelo
- Inhalt
- Sommario
- Sommaire
- Obsah

Overview ceiling diffusers / Oversigt loft armaturer / Översikt takdon / Yleiskatsaus kattohajottajat /  
 Übersicht Deckendurchlässe / Panaoramica diffusore a soffitto / Aperçu diffuseurs plafonniers / Přehled stropních  
 difuzorů.....2

LKP(-P).....3

Accessories / Tilbehør / Tillbehör / Tilauksesta / Zubehör / Accessori / Accessoires / Příslušenství.....4

Ceiling systems / loftsystemer / Undertakssystem / Kattojärjestelmät / Deckensysteme /  
 Sistemi di controsoffitto / Systèmes de plafond / Stropní systémy.....5

Installation of MB/MBV/CBC/CBE + diffuser / Installation af MB/MBV/CBC/CBE + armatur / Montering av MB/MBV/  
 CBC/CBE + don / Asennusohje MB/MBV/CBC/CBE + hajottaja / Montage der MB/MBV/CBC/CBE + Durchlass /  
 Montaggio MB/MBV/CBC/CBE + diffusore / Montage de MB/MBV/CBC/CBE + diffuseur / Montáž MB/MBV/CBC/  
 CBE+difuzor.....6

## LCP LKP LCC

Ceiling diffusers suitable for Pascal/ Loft armaturer egnet til Pascal/ Takdon lämpliga for Pascal /  
 Pascal-järjestelmään soveltuvat kattohajottajat / Deckendurchlässe für Pascal geeignet /  
 Diffusori a soffitto adatti per Pascal / Diffuseurs plafonniers adaptables à Pascal /  
 Stropní difuzor vhodný pro Pascal



**LCP**  
LCP -P, -T, -P-T



**LKP**  
LKP -P



**LCC**  
LCC -P, -T, -P-T

## MB MBV CBC/CBE

Installation of MB/MBV/CBC/CBE / Installation af MB/MBV/CBC/CBE / Montering av MB/MBV/  
 CBC/CBE / Asennusohje MB/MBV/CBC/CBE / Montage der MB/MBV/CBC/CBE / Montaggio MB/  
 MBV/CBC/CBE / Montage de MB/MBV/CBC/CBE Montáž MB/MBV/CBC/CBE

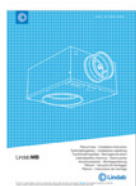

[Link to MB](#)



[Link to MBV](#)

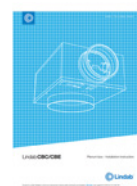

[Link to CBC/CBE](#)

## Symbols Symboler Symboler Symbolit Symbole Simboli Symboles Symboly



2 x sensor - 2 x sensor - 2 x sensor  
 2 x antureita - 2 x Melder - 2 x Sensora  
 2 x Détecteur - 2 x čidla



Presence sensor - Bevægelsessensor  
 Nävarosensor - Liiketunnistin - Präsenzmelder  
 Sensora di presenza - Détecteur de présence -  
 Pohybové čidlo



Temperature sensor - Temperatursensor  
 Temperatursensor - Lämpötila-anturi - Temperaturmelder  
 Sensora di temperatura - Détecteur de température -  
 Teplotní čidlo

# Integra

# LKP

Measure/weight  
Mål/vægt  
Mått/vikt  
Mitta/paino  
Abmessungen/Gewicht  
Misure/peso  
Dimensions / poids  
Rozměry/hmotnost

Ød mm	kg
125	3.2
160	3.2
200	3.3
250	3.4
315	3.5

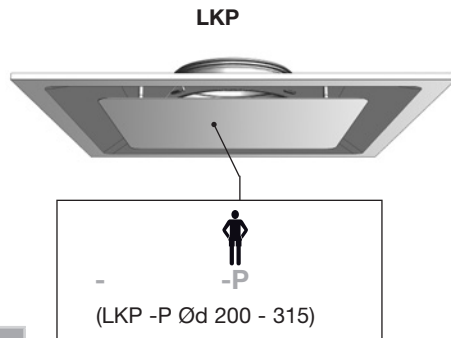

LKP + MB/MBV/CBC/CBE

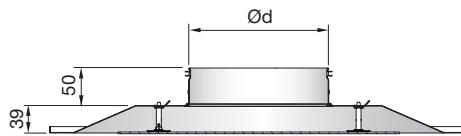

UK - Upper part adapted to ceiling system  
SE - Övre delen av donet anpassas till undertaket  
DE - Oberteil für Deckensystem angepasst  
FR - Partie supérieure adaptée au type de plafond  
DK - Overpart tilpasses loftsystm  
FI - Yläosa sovitettu kattojärjestelmään  
IT - Parte superiore adattata al controsoffitto  
CZ - čelní deska přizpůsobena stropu

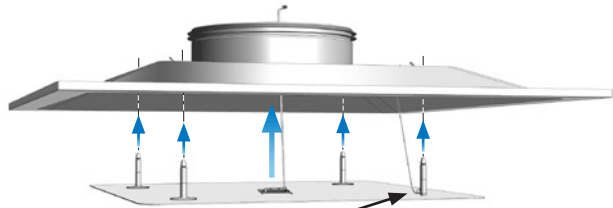
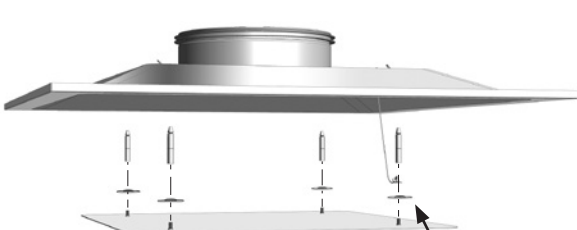

UK No tools  
DK Ingen værktøj  
SE Inga verktyg  
FI Ei työkaluja  
DE Keine Werkzeuge  
IT Nessun attrezzo  
FR Sans outil  
CZ Bez nářadí

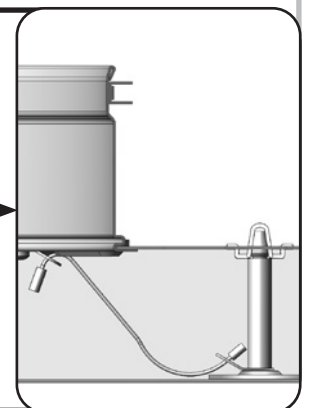
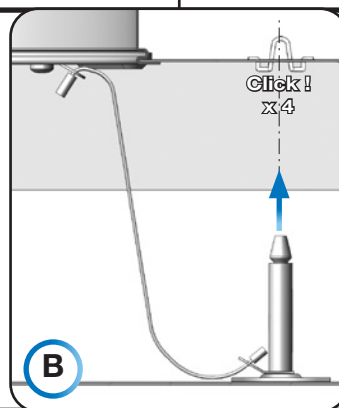
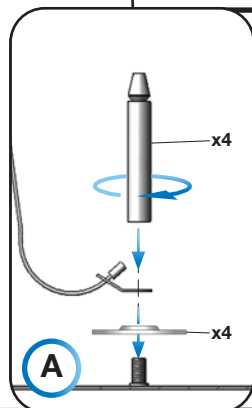
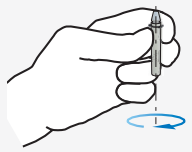

Order code  
Ordre kode  
Beställningskod  
Tuotekoodi  
Bestellcode  
Codice d'ordine  
Codification  
Kód pro objednávání

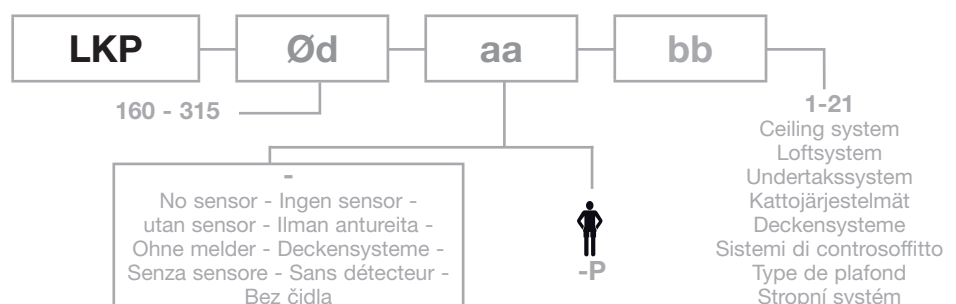

# Integra

# LKP

- MBZ - Optional accessories**
- MBZ - Ekstra tilbehør**
- MBZ - Tillbehör som tillval**
- MBZ - Lisavarusteet tilauksesta**
- MBZ - Zubehör**
- MBZ - Accessori su richiesta**
- MBZ - Accessoires optionnels**
- MBZ - Příslušenství**

## MBZ

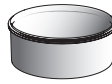

- Extension piece
- Forlængerstykke
- Förlängningsstos
- Jatkokappale
- Verlängerungsstutzen
- Manicotto maschio femmina di prolungamento
- Rallonge
- Prodlužovací kus

- Order code**
- Ordre kode**
- Beställningskod**
- Tuotekoodi**
- Bestellcode**
- Codice d'ordine**
- Codification**
- Kód pro objednávání**

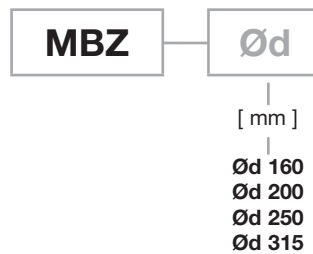

### LKP + MB/MBV/CBC/CBE



- Example: MBV
- Eksempel: 160-250-S
- Exempel: +
- Esimerkki: MBZ
- Beispiel: +
- Esempio: +
- Exemple: LKP-200
- Příklad: LKP-200

Ceiling systems    loftsystemer    Undertakssystem    Kattojärjestelmät    Deckensysteme  
 Sistemi di controsoffitto    Systèmes de plafond    Stropní systémy

**1.**  
**21.**

T24/T15 = 600 x 600  
 21 = 625 x 625

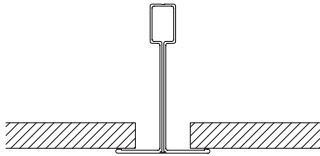

**2.**  
**22.**

T24/T15 = 600 x 600  
 22 = 625 x 625

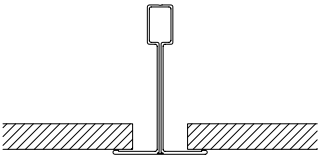

**3.**

Permanent ceiling  
 Fast loft / Fast undertak  
 Kiinteä alakatto  
 geschlossene decke  
 Soffitto permanente  
 Plafond non démontable  
 Pevný strop



**4.**

Dampa Clip-in

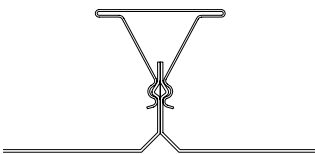

**5.**

Dampa Clip-in

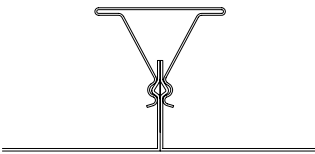

**6.**

Luxalon Clip-in

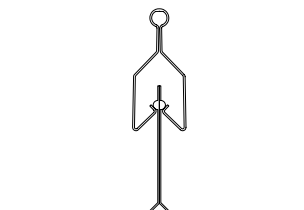

**7.**

Danotile Contur / Ecophon D  
 Rockfon D-XL

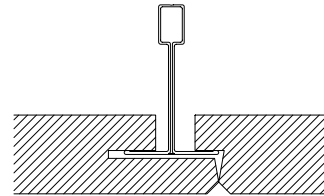

**8.**

Ecophon Focus DG

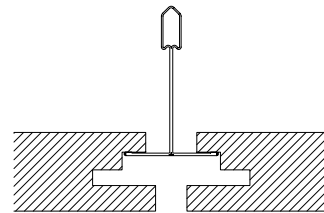

**9.**

Rockfon E10 24 / Ecophon E / T24

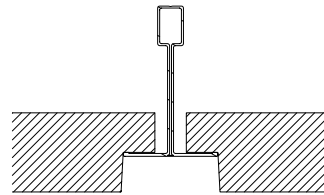

**10.**

Rockfon E10 15 / Ecophon E / T15

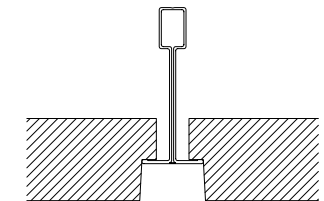

**11.**

Danotile Markant

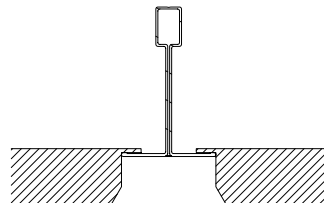

**14.**

Ecophon Focus DS

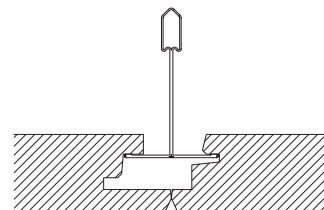

# Integra

# LKP + MBV

**Installation of diffuser in MB/MBV/CBC/CBE**  
**Montering af armatur i MB/MBV/CBC/CBE**  
**Montering av don i MB/MBV/CBC/CBE**  
**Hajottajan asennus MB/MBV/CBC/CBE-laatikoon**  
**Durchlassmontage im MB/MBV/CBC/CBE**  
**Montaggio del diffusore in MB/MBV/CBC/CBE**  
**Montage du diffuseur dans MB/MBV/CBC/CBE**  
**Montáž difuzoru do MB/MBV/CBC/CBE**



LKP Ød = MBV Ød<sub>2</sub>

**LKP**  
**Ød = 160 - 250**

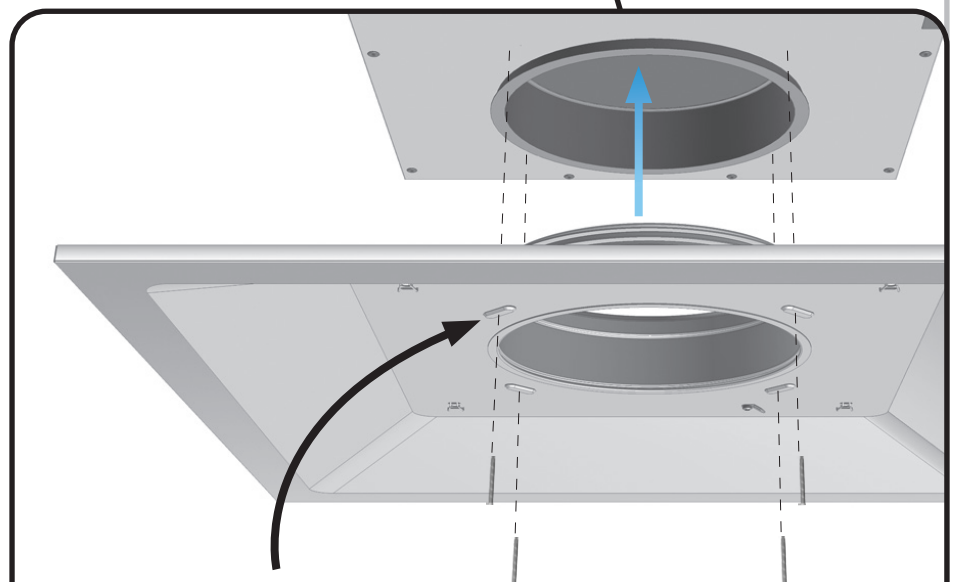
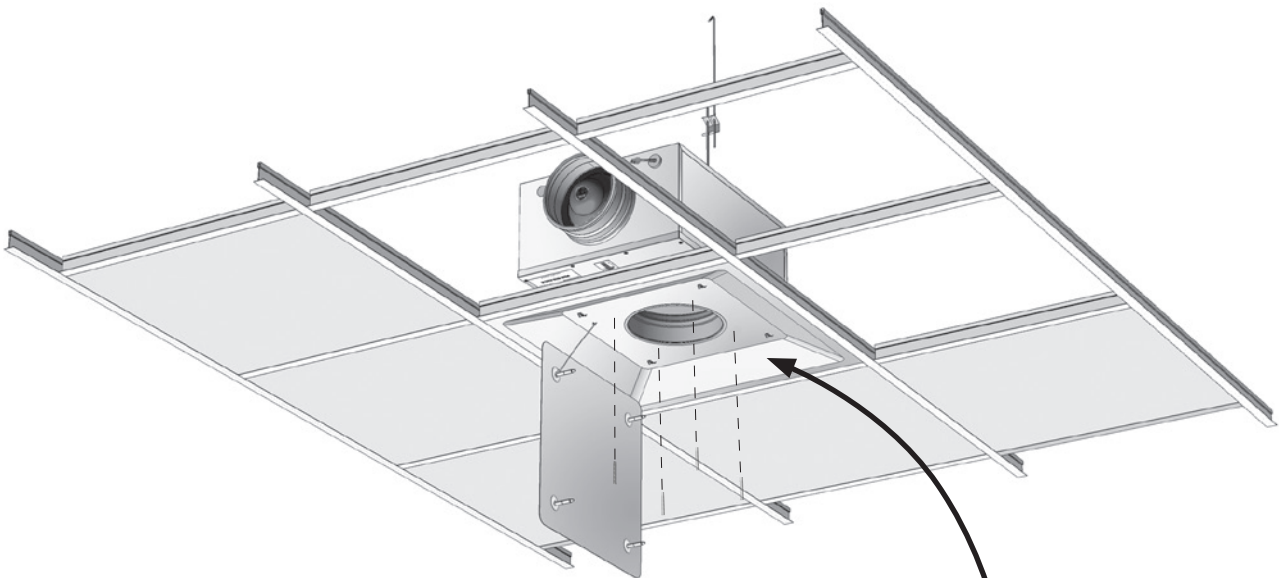

Holes for MB mounting  
 Huller til MB montage  
 Hål för MB montering - SWE  
 Reijät MB asennukseen  
 Löcher für montage im MB  
 Fori di montaggio per MB  
 Trous de montage pour MB  
 Díry pro montáž MB

4 x Ø4,8 x 50



# Integra

# LKP + MBV

**Installation of diffuser in MB/MBV/CBC/CBE**  
**Montering af armatur i MB/MBV/CBC/CBE**  
**Montering av don i MB/MBV/CBC/CBE**  
**Hajottajan asennus MB/MBV/CBC/CBE-laatikoon**  
**Durchlassmontage im MB/MBV/CBC/CBE**  
**Montaggio del diffusore in MB/MBV/CBC/CBE**  
**Montage du diffuseur dans MB/MBV/CBC/CBE**  
**Montáž difuzoru do MB/MBV/CBC/CBE**



**LKP**  
**Ød = 315**

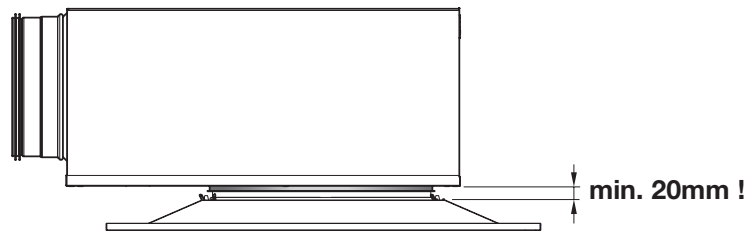

### Ød 315 !

NO holes for MB/MBV/CBC/CBE mounting on diffuser !  
 INGEN huller til MB/MBV/CBC/CBE montage på armaturet !  
 Inga hål för MB/MBV/CBC/CBE montering på donet  
 Ei reikiä MB/MBV/CBC/CBE asennukseen !  
 KEINE Löcher für montage im MB/MBV/CBC/CBE auf Durchlass !  
 Nessun foro per il montaggio del plenum MB/MBV/CBC/CBE al diffusore !  
 PAS de trous pour le montage du MB/MBV/CBC/CBE sur le diffuseur !  
 Žádné otvory pro montáž difuzoru do MB/MBV/CBC/CBE!

4 x Ø4,8 x 50

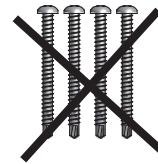

Not used  
 Anvendes ikke  
 Används inte  
 Ei käytetä  
 Nicht verwendet  
 Non utilizzate  
 Non utilisé  
 Nepoužívejte

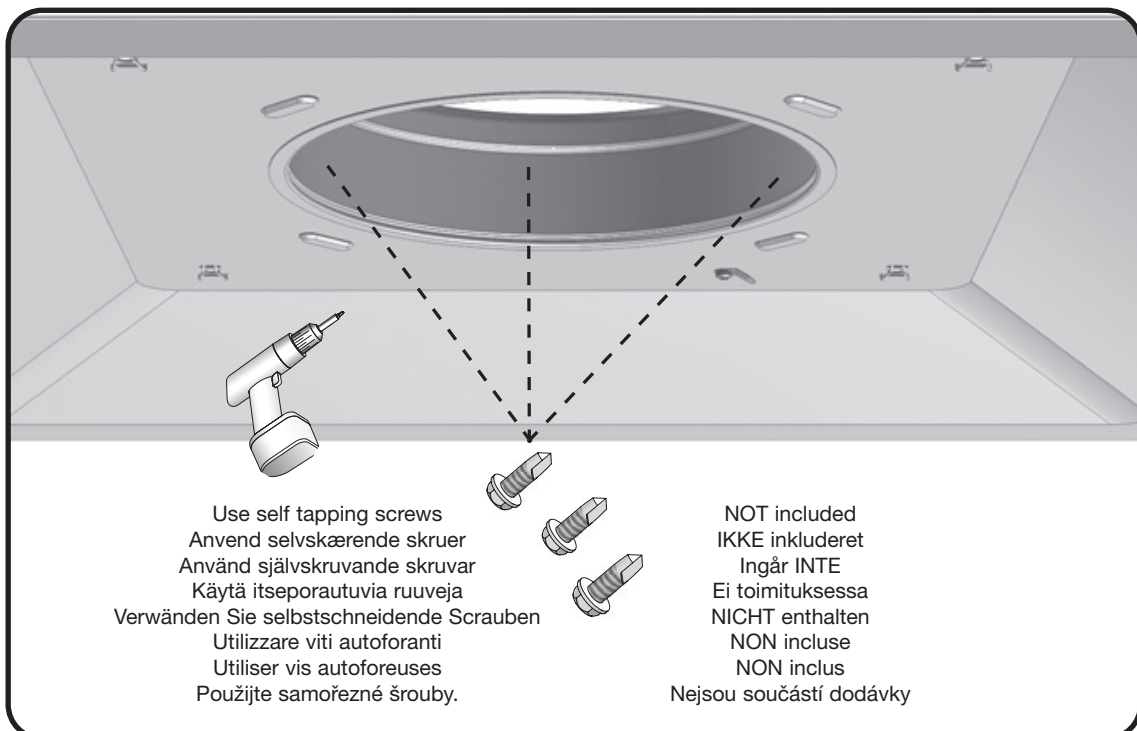

Use self tapping screws  
 Anvend selvskærende skruer  
 Använd självskruvande skruvar  
 Käytä itseporautuvia ruuveja  
 Verwenden Sie selbstschneidende Schrauben  
 Utilizzare viti autoforanti  
 Utiliser vis autoforeuses  
 Použijte samořezné šrouby.

NOT included  
 IKKE inkluderet  
 Ingår INTE  
 Ei toimituksessa  
 NICHT enthalten  
 NON incluse  
 NON inclus  
 Nejsou součástí dodávky



Most of us spend the majority of our time indoors. Indoor climate is crucial to how we feel, how productive we are and if we stay healthy.

We at Lindab have therefore made it our most important objective to contribute to an indoor climate that improves people's lives. We do this by developing energy-efficient ventilation solutions and durable building products. We also aim to contribute to a better climate for our planet by working in a way that is sustainable for both people and the environment.

Lindab | For a better climate