



Lindab **MBV**

VAV plenum box



VAV plenum box

MBV



Description

MBV is a plenum box with integrated volume flow regulator used for VAV regulation of supply air diffusers LCP, LKP and LCC. MBV is equipped with a unique linear cone damper technology which makes it possible to regulate up to 200 Pa with low sound level. Using MBV in the Pascal system, the MBV is controlled by a Regula Combi room controller. No factory settings or specific room labeling is needed.

- Accurate and reliable VAV regulation
- No factory settings needed
- Up to 200 Pa with low sound level
- Integrated volume flow regulator
- Used in combination with LCP/LKP/LCC
- Possible integrated Regula Combi on CT

Order code

Product	MB	V	aaa	bbb	ccc	dd	ee	f	gg	h
Type	MB									
Damper	V									
Duct connection Ød₁ Ø 125-250										
Diffuser dimension Ød₂ Ø 200-315										
Motor type *										
MP = MP (Standard / Pascal)										
MOD = Modbus / Bacnet										
KNX = KNX										
Regula *										
0 = No										
CN = Regula Connect Pascal										
CT = Regula Control Pascal										
Regula Combi *										
0 = No										
RC = Regula Combi (ONLY for Regula CT)										
Lighting control *										
0 = No										
L = Regula Lux										
Power supply *										
0 = No										
20 = Trafo 20VA										
IP Cover *										
S = Steel Cover IP20 (Included with Regula CN and CT)										
P = Plast Cover box IP54 (ONLY for Regula CT)										

* Only available with MP Motor type (Standard / Pascal).

Example: MBV-160-250-MP
Example: MBV-160-250-MP-CT-RC-L-20-P

Quickselection incl. diffuser LCP

MBV		$\Delta p_t = 50 \text{ Pa}$ 35 dB(A)		$\Delta p_t = 150 \text{ Pa}$ 35 dB(A)	
Inlet Ød ₁	Outlet Ød ₂	l/s	m ³ /h	l/s	m ³ /h
125	200	73	263	62	223
160	250	113	408	95	340
200	315	145	521	123	444
250	315	168	605	129	464

Airflow limits

MBV		Lower regulation limit (0.56 m/s)*		Airflow Nominal (7.0 m/s)	
Inlet Ød ₁	Outlet Ød ₂	l/s	m ³ /h	l/s	m ³ /h
125	200	7	25	86	309
160	250	11	41	141	507
200	315	18	63	220	792
250	315	27	99	344	1237

*) Lower airflow is still measured, but regulation switches between closed and 8% of V_{nom}, which is a fixed Belimo setting.

Specification Air volume controller (MP)

Belimo VAV-Compact LHV-D3W-MP LIN.

We refer to Belimos documentation of LHV-D3-MP, which can be found on www.belimo.com.

LHV-D3W-MP LIN is a Lindab version of LHV-D3-MP with special rack and size dependent damper characteristics.

Motortype

Type	Documentation
MP	LHV-D3W-MP LIN
MOD/BAC	LHV-D3W-MOD LIN*
KNX	LHV-D3W-KNX LIN*

*) For the [MOD/BAC](#) & [KNX](#) variants see documentation for rotation version (LMV) of Belimo VAV-Compact-D3, as the MOD/KNX related information/signals is the same for the linear version (LHV).

Rack stroke mechanically limited according to size

Size Ød ₁ , mm	125	160	200	250
Rack stroke mm	110	137	157	188

Maintenance

The motorized damper-unit can be removed to enable cleaning of internal parts of the plenum box and gives access to the duct as well.

Materials and finish

Material: Galvanised steel
Standard Colour: Galvanized steel

Please contact Lindab's sales department for further information.

VAV plenum box

MBV

MBV standard dimensions

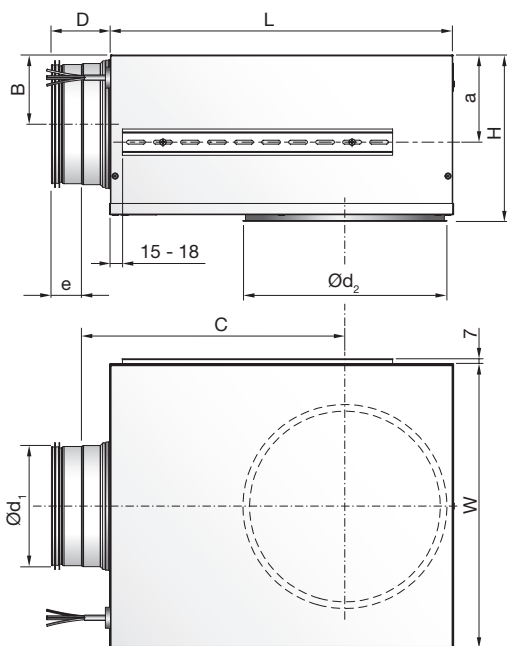

Ød ₁ mm	Ød ₂ mm	a	B	C	D	e	H	L	W	m kg
125	200	96	75	291	78	40	188	376	310	4.2
160	250	116	92	352	78	40	222	459	380	6.0
200	315	116	112	425	78	40	263	565	460	7.8
250	315	116	137	514	118	60	313	698	540	11.1

MBV features dimensions

Note that as soon as choosing either CN or CT card, the MBV will include 3x slotted cable ducts, a back plate and a standard protection cover, which will increase outer dimensions of the configured MBV.

Regula Control Pascal, IP54 dimensions.
Order example: MBV-160-250-CT-RC-20-P
(Where CT and RC are inside IP54).

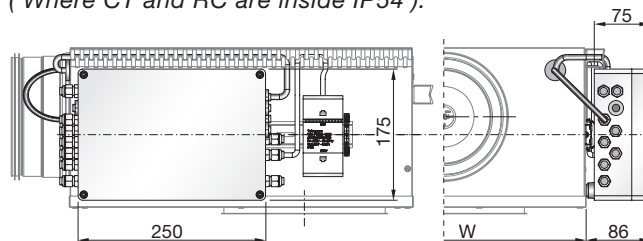

Trafo 20VA dimensions.

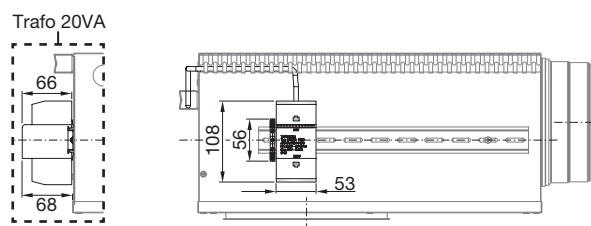

Regula Connect Pascal, slotted cable ducts and back plate dimensions.

Order example: MBV-160-250-CN.

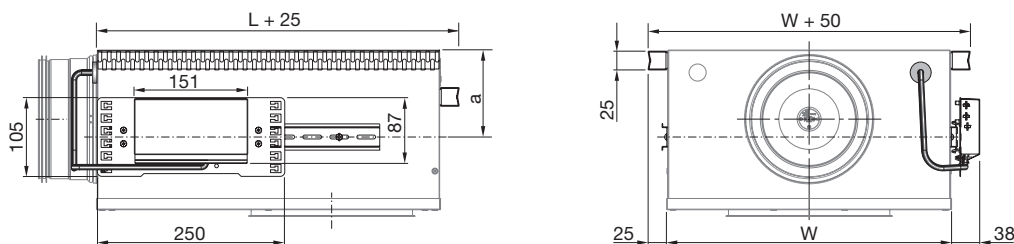

Regula Control Pascal, Regula Lux dimensions

Order example: MBV-160-250-CT-RC-L-20.
(Note that trafo is on other side of MBV).

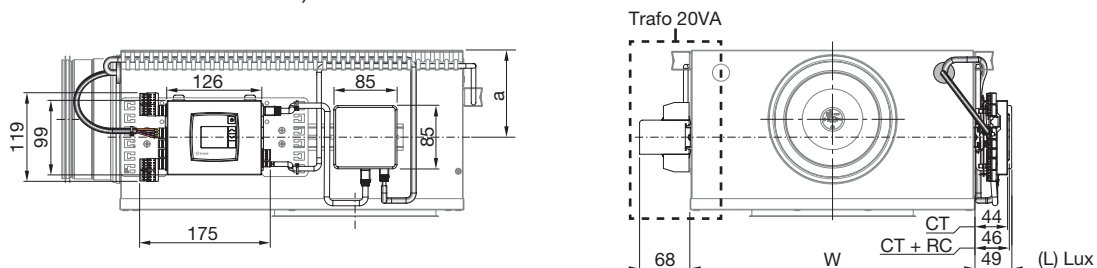

VAV plenum box

MBV

Technical data

MBV should be used with LCP/LKP/LCC diffusers. For data sets including sound diagrams and K_{ok} -values valid for all MBV + diffuser size combinations, go to LCP/LKP and LCC documentation.

Air flow measurement

Recommended lengths L of straight duct between a disturbance and MBV .

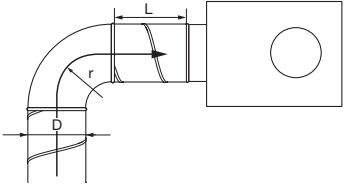
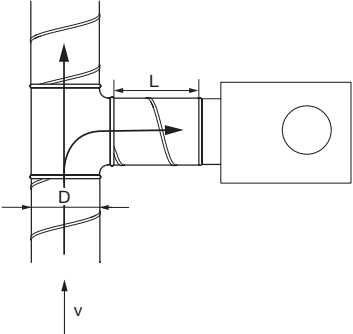
<p>Bend with radius $r > D$</p> 	1D
<p>Box installed at the side branch of the distribution duct; for velocities in the distribution duct $v > 4$ m/s</p> 	3D
<p>A general disturbance (none of the cases above)</p>	1D-4D

Accuracy

Damper position > 30% (Open = 100%)

The highest value of $\pm 7\%$ of reading or $\pm 1\%$ of V_{nom} (flow at 7 m/s).

Damper position < 30% (Open = 100%)

The highest value of $\pm 7\%$ of reading or $\pm 2.5\%$ of V_{nom} (flow at 7 m/s).

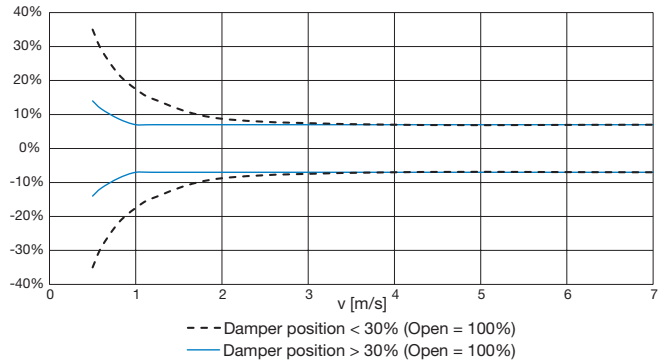

$\pm 7\%$ or table value (highest)

MBV	>30%	<30%
$\varnothing d_1$	$\pm 1\% V_{nom}$	$\pm 2.5\% V_{nom}$
mm	l/s	l/s
125	± 1.0	± 2.2
160	± 1.4	± 3.5
200	± 2.2	± 5.5
250	± 3.4	± 8.6

Leakage through closed damper

Inlet $\varnothing d_1$	Closed damper leakage at 50 Pa**	
	l/s	m ³ /h
125	4.8	17.3
160	5.4	19.4
200	8.3	29.9
250	9.8	35.3

***) The damper is class 0 according to EN 1751, but the table shows the approximate leakage when the damper is fully closed.

If calculating for other pressures, use an exponent = 0.6.

VAV plenum box

MBV

Sound power level

Sound from Belimo motor, less than 25 dB (A) when regulating.
 Max. 35 dB (A) when overriding to forced ventilation or closed.

Lindab factory settings:

Damper is programmed with size dependent calibration settings.

Analogue feedback signal is damper position as default.

When used for Pascal:
 Settings for $V_{max} = 100\%$ and $V_{min} = 0\%$ should not be changed. Airflow limits are set in Regula Combi.

Type overview, MP versions

Type	Force	Power consumption	Rating	Weight
LHV-D3-MP-LIN	150 N	2.5 W	4.5 VA	Approx 550 g

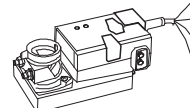

No.	Designation	Wire colour	Function
1	┴ -	black	} AC/DC 24 V supply
2	~ +	red	
3	◀ Y	white	Reference signal / override / sensor
5	▶ U	orange	- Actual value signal - MP bus connection

Note !

- Supply via safety isolating transformer !
- In conventionally controlled systems it is recommended that the connections 1 to 5 (PP) are led to accessible terminals (e.g. floor distributor) in order to allow remote access for diagnostics and service work.

Type overview MOD versions

Type	Force	Power consumption	Rating	Weight
LHV-D3-MOD-LIN	150 N	2.5 W	4.5 VA	Approx 550 g



No.	Designation	Wire colour	Function
1	┴ -	black	} AC/DC 24 V supply
2	~ +	red	
3			
5	▶ MFT	orange	MP connection
6	D-	pink	} BACnet / Modbus (RS485)
7	D+	grey	

Note !

- Supply via safety isolating transformer !
- Modbus signal assignment:
 $C_1 = D- = A$
 $C_2 = D+ = B$
- Supply and communication are not galvanically isolated.
- Connect earth signal for devices with one another.

Type overview KNX versions

Type	Force	Power consumption	Rating	Weight
LHV-D3-KNX-LIN	150 N	2.5 W	4.5 VA	Approx 550 g

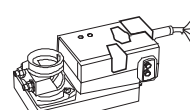

No.	Designation	Wire colour	Function
1	┴ -	black	} AC/DC 24 V supply
2	~ +	red	
3			
5	▶ MFT	orange	PP connection
6	D+	pink > red	} KNX
7	D-	grey > black	

Note !

- Supply via safety isolating transformer !
- Signal assignment KNX:
 $D+ = KNX+ (pink > red)$
 $D- = KNX- (grey > black)$
- The connection to the KNX line should take place via WAGO connection terminals 222/221.

VAV plenum box

MBV

MBV overview

MBV motor type (MP)

MBV Air volume controller

The Belimo motor LHV-D3W-MP-LIN is the air volume controller of the motorized detachable damper unit of the MBV. Measuring tubes installed from factory should not be disconnected.

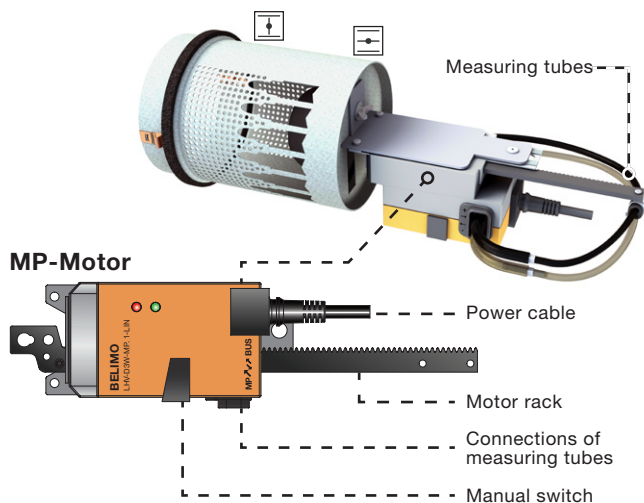

MBV Pascal features

Directly in the order code configure the MBV VAV Plenum box as desired. The MP Motor type must be chosen to design a Pascal system.

Besides the Connect card (CN) Lindab now offers the even more versatile Control card (CT), which gives the choice of ordering your Regula Combi (RC) directly pre-installed on the CT (RC), or as an external unit (Must be ordered separately.)

If selecting RC preinstalled on the CT card, remember to use an external room temperature sensor, e.g. in the Pascal diffuser (or as a separate room or extract duct sensor).

Back plate for card, protective steel cover and 3 x slotted cable ducts/trays are as standard included, when selecting either the CN or the CT card.

Regula Control card (CT)

A patch cable is included, preconnected to the CT Presence / temperature port, running into the MBV, leaving female end ready for sensor connection. Sensor choice is made when ordering a Pascal diffuser (LCP, LKP, LCC).

When installing, simply click-in diffuser sensor cable to the patch cables female end. NOTE! The LKP is not available with temperature sensor.

Choices of optional Pascal equipment made in the order code will be preinstalled and cabled-up from factory.

MBV Configuration options

Regula Connect Pascal (CN)

The Regula Connect Pascal is a connection hub where input/output for regulation, sensors and power supply will be connected. Ordered with the MBV, the CN card will come preinstalled on box with standard protection cover. Easy connection to external room controller Regula Combi (RC).

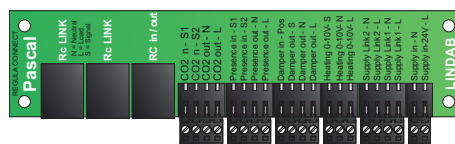

Regula Control Pascal (CT)

The Regula Control Pascal is a connection hub with even more versatile possibilities for input/output of regulation, sensors and power supply connections. Ordered with your MBV, the CT card will come preinstalled on the MBV with standard protection cover. The CT card offers the possibility to have the Regula Combi (RC) integrated directly on the CT card.

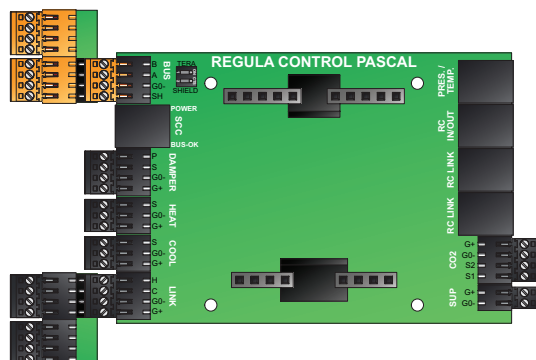

Pascal programs and wiring

Design the Pascal system using the LindQST Wiring Scheme [configurator](#). Chose Pascal program, CN or CT card, and auto generate wiring scheme for your chosen equipment.

Regula Combi Pascal (RC)

Regula Combi is a room controller which can be ordered integrated on your CT-card (adding another separate room temperature sensor). If preferring an external Regula Combi, the controller unit must be ordered separately.

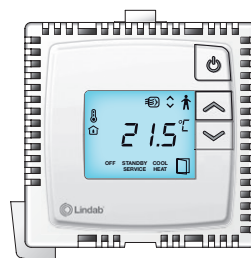

RC orderd with MBV for installation on CT card.



RC for external use. (Ordered separately).

VAV plenum box

MBV

MBV Configuration options

Regula lux (L)

Regula Lux is a lighting relay which receives a signal from a presence sensor.

When ordered with MBV and CT-card, the Lux will be pre-cabled with 2 cables; a RJ45 cable to the Presence/Temperature port on the CT-card and a patch cable which will leave female end inside MBV box, ready for connection of sensor.

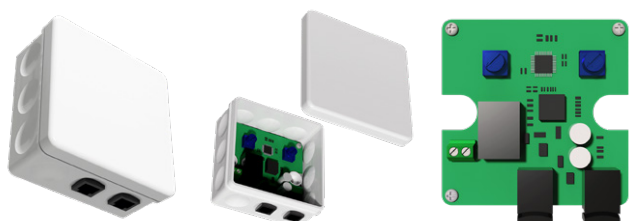

Power supply 20VA

It is possible to add a 20 VA trafo power supply, it comes mounted on DIN but without cables.

Trafo 20VA

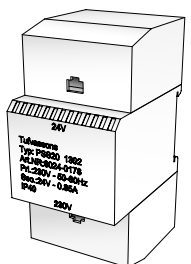

Weidmüller BL 3.5 plugs

Your CN / CT cards will be fully pre-plugged from factory, no need for ordering separately. Just connect your other equipment using the plugs.

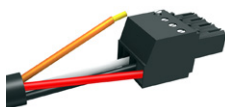

IP 30 standard steel covers (S)

The CN / CT cards come with standard covers according to the configuration.

CT-S Standard

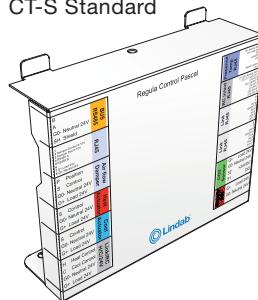

CT-RC-S Standard

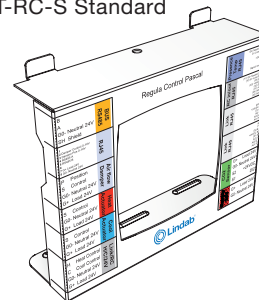

CN-S Standard

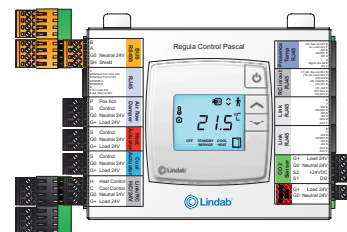
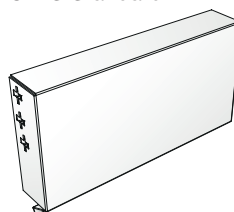

IP54 Plast cover box (P)

The IP54 is for the CT card only. Select this instead of standard cover, enclosing and protecting the Regula Control Pascal card (CT).

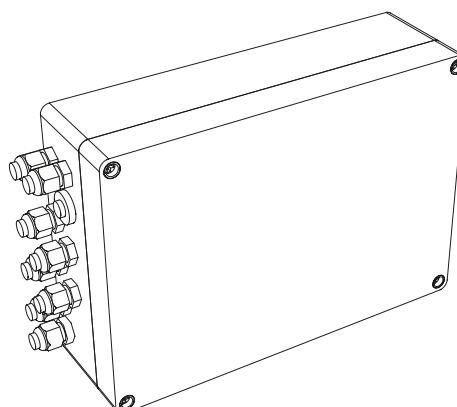

VAV plenum box

MBV

MBV configuration examples. Regula Connect (CN) and Control (CT)

The standard MBV box

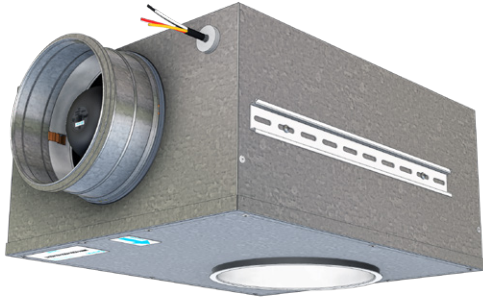

Order example: MBV-160-250-MOD.

CN card solution with steel cover

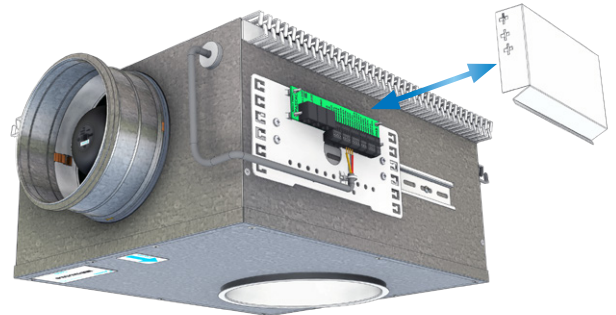

Order example: MBV-160-250-CN.

CT card solution with Regula Combi and steel cover.

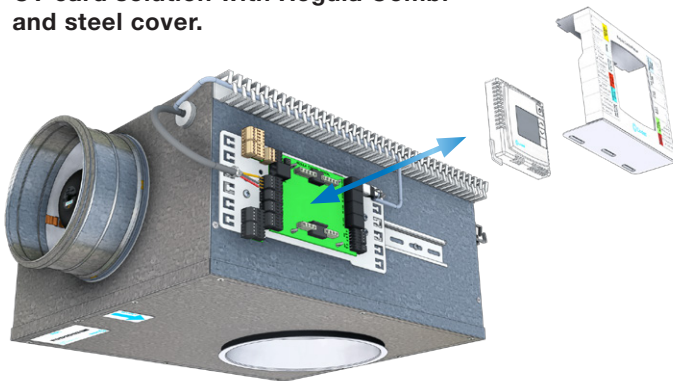

Order example: MBV-160-250-CT-RC.

CT card solution with Regula Combi, steel cover and trafo.

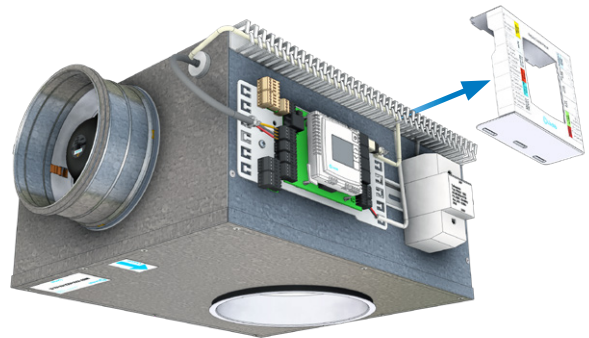

Order example: MBV-160-250-CT-RC-20.

CT card solution with Regula Combi, IP54 plast cover box, Regula Lux and trafo.

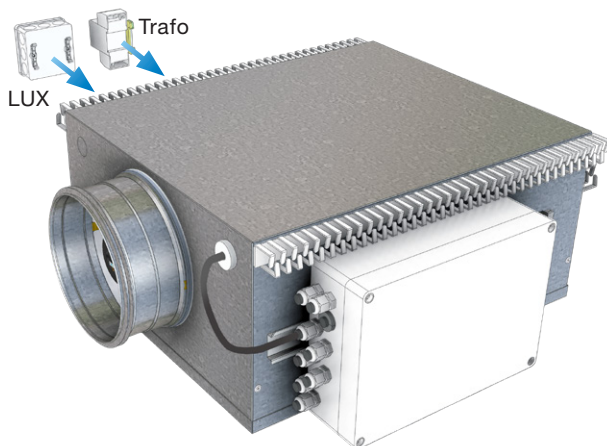

Order example: MBV-160-250-CT-RC-L-20-P.

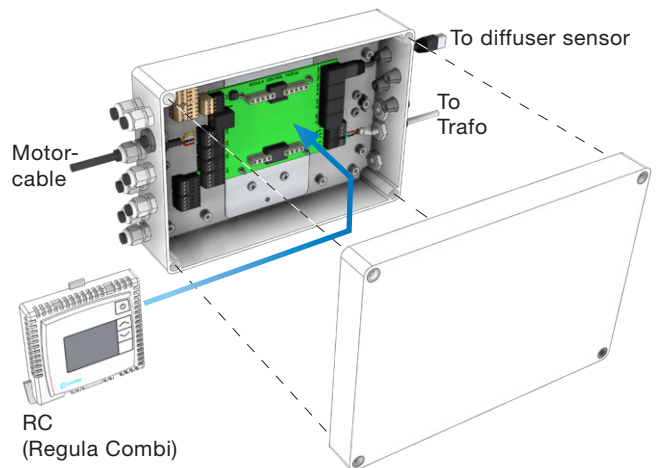

The IP54 plast cover box is available for the CT card only, and offers exceptionally good protection for both the CT and the connections. Possibility to have an on-board RC (Regula Combi). Other items will be placed on opposite rail, but will still be fully cabled up from factory.



Most of us spend the majority of our time indoors. Indoor climate is crucial to how we feel, how productive we are and if we stay healthy.

We at Lindab have therefore made it our most important objective to contribute to an indoor climate that improves people's lives. We do this by developing energy-efficient ventilation solutions and durable building products. We also aim to contribute to a better climate for our planet by working in a way that is sustainable for both people and the environment.

[Lindab](#) | For a better climate