



Lindab **Zinc-Magnesium Duct System**

Technical information

Content

Duct system of Zinc-Magnesium ZM 310.....	3
Products.....	3
The circular duct system.....	3
Material description	3
Appearance.....	3
Sheet steel properties.....	3
Lifetime.....	3
Trimming edges.....	3
Corrosivity classes according to ISO 12944-2 with environmental examples	4
Eurovent certification	4
Corrosion	4
Corrosive Class.....	4
Environment	4
Product Overview.....	5
Ducts.....	5
Bends.....	6
Cleaning bends	14
Reducers.....	15
T-pieces.....	23
X-pieces	27
Take-offs	29
Couplings	32
End caps	34
Access doors	35
Dampers.....	36
Duct suspension and support system.....	38
Fasteners	40

Duct system of Zinc-Magnesium ZM 310

A corrosion-resistant duct system for high environmental requirements

Products

The purpose of this brochure is to present which of Lindab's duct system products that is available in the Zinc-Magnesium coated steel sheet material. More detailed technical information about the system and the products can be found in our brochure "General Information and Theory" or the product's website. Zinc-Magnesium products are usually handmade instead of pressed and can therefore differ from the standard galvanized assortment in size and weight.

The circular duct system

The circular system is part of the Lindab Safe range and is manufactured as standard with a double lipped gasket made of EPDM rubber. The standard dimensions are adapted to EN 1506, which is made with over bent edge, which provides excellent structural stability and increased durability against damage caused by handling. For chemical environments other than EPDM gasket can withstand, see also how our silicone gasket is performing in the brochure "General Information and Theory". The products can also be obtained without gasket if none of our gasket options meet the requirements.

Material description

Zinc-Magnesium is a zinc-Magnesium coated steel sheet that can be used unpainted up to corrosive class C5.

See table on next page for information about corrosive classes.

The alloy of the metal coat has a weight percentage of 3% Magnesium, 3,5% aluminium and 93,5% zinc with a coat weight of 310 g/m² per double side.

Appearance

The surface is initially glossy metal with a rose pattern but after some time it turns greyish, and eventually it becomes matt grey.

Sheet steel properties

Zinc -Magnesium coated steel sheet ZM310	According to SS-EN 10346:2015
Fire Resistance Classification	A1 (EN 13501-1)

Lifetime

The layer of Zinc-Magnesium has a thickness of approx. 24 µm (0.024mm) per side and can in some cases be an alternative to stainless steel.

Due to corrosive and appearance related reasons, the following combinations should be avoided to prevent them from affecting the aesthetic and technical lifetime:

- Zinc-Magnesium in combination with copper, brass or lead can cause galvanic corrosion. Avoid drainage from constructions and roofs that contain these metals. In particularly aggressive environments.
- Zinc-Magnesium in contact with noble woods, damp wood or wood with waterproofing containing copper can cause black rust or corrosion.
- Zinc-Magnesium in combination with bitumen products without a UV stabiliser.
- Zinc-Magnesium in combination with wet concrete, cement and plastering that are very alkaline can cause discolouration or black rust.

Trimming edges

Corrosion on the edges can occur in environments that are exposed to corrosion and in which the edges of the sheet are exposed. Normally, the trimmed edges do not need to be painted with a protective paint. Protective paint can be applied in environments in which the trimmed edges are aesthetically prominent.

Corrosion

Zinc-Magnesium has an ability to repair itself which makes the material resistant to corrosion caused by scratches.

The long lifetime is due to the fact that the zinc-Magnesium coating provides the steel sheet with a double protection against corrosion. The first protection factor is the coating on the steel sheet that forms a passivating barrier against general corrosion. The other protection factor involves the formation of a galvanic element when the sheet is exposed to moisture (electrolyte), resulting in zinc ions flowing over and protecting the exposed steel against corrosion in scratches or trimmed edges.

Corrosive Class

Zinc-Magnesium can be used up to corrosive class C5 in accordance with EN ISO 12944-2.

Environment

The long lifetime of Zinc-Magnesium, in comparison with for instance hot dip galvanised sheets, entails major environmental benefits. There is a worldwide infrastructure for recycling steel that works well. Once steel is produced, it is part of a constant cycle as steel always contains recycled materials. Steel is always 100% recyclable, the metal layer does not pose any problems for remelting.

Eurovent certification

Lindab's circular duct system with rubber gasket connections Lindab Safe and Lindab Safe Click is certified to strength and leakage in tightness class D according to the Eurovent Certified Performance program for circular metallic ducts systems (DUCT-MC). Check ongoing validity of certificate:

www.eurovent-certification.com



The purpose of Eurovent third party Certification is to create a common set of criteria to all relevant features for the rating of products in this system and ensure the constancy of performance over time.

Through specification of products in Lindab's certified system, Lindab Safe and Lindab Safe Click, the engineer's tasks become easier, since there is no need to carry out detailed comparison and performance qualification testing. Consultants, specifiers and users can select products with the assurance that the catalogue data are accurate to a certain level.

Lindab products that are Eurovent certified have the Eurovent logotype in the footer of the technical documentation.

Note: Most Lindab Safe and Lindab Safe Click and the most commonly used product in a ventilation system are essentially better than class D, however some products are according to EN 15727 not class D as a single product. These products are stated in the documentation as Class C and can be used in D class systems to a limited extension.

Corrosivity classes according to ISO 12944-2 with environmental examples

Corrosivity category	Corrosivity	Examples of typical environments (informative only)	
		Exterior	Interior
C1	Very low	-	Heated buildings with clean atmosphere, e.g. offices, shops, schools, hotels.
C2	Low	Atmospheres with low level of pollution: mostly rural areas.	Unheated buildings where condensation can occur, e.g. depots, sports halls.
C3	Medium	Urban and industrial atmospheres, moderate sulfur dioxide pollution; coastal areas with low salinity.	Production rooms with high humidity and some air pollution, e.g. food-processing plants, laundries, breweries, dairies.
C4	High	Industrial areas and coastal areas with moderate salinity.	Chemical plants, swimming pools, coastal ship and boatyards.
C5	Very high	Industrial areas with high humidity and aggressive atmosphere and coastal areas with high salinity.	Buildings or areas with almost permanent condensation and with high pollution.
CX	Extreme	Offshore areas with high salinity and industrial areas with extreme humidity and aggressive atmosphere and subtropical and tropical atmospheres.	Industrial areas with extreme humidity and aggressive atmosphere.

Product Overview

Ducts

Circular duct system

SR, circular duct

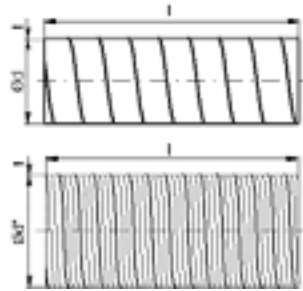

Ød nom	t mm	m kg/m	Comment
80	0,6	1,21	
100	0,6	1,52	
112	0,6	1,71	
125	0,6	1,88	
140	0,6	2,11	
150	0,6	2,27	
160	0,6	2,42	
180	0,6	2,71	
200	0,6	3,07	
224	0,6	3,44	
250	0,6	3,82	
280	0,6	4,28	
300	0,6	4,58	
315	0,6	4,81	
355	0,6	5,41	
400	0,6	6,56	
450	0,6	7,37	
500	0,7	9,54	
560	0,7	10,7	
600	0,7	11,5	
630	0,7	12,0	
710	1,0	19,4	
800	1,0	21,8	
900	1,0	24,1	
1000	1,0	26,8	
1120	1,0	30,0	
1250	1,0	33,6	

For more detailed information about technical data and measures see datasheet for [SR](#)



Circular duct system

Bends

BFU 90°, lockseamed bend

Technical data

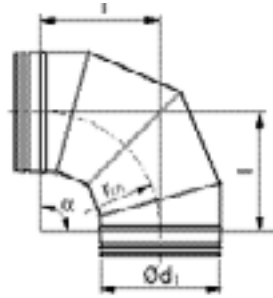

Ød, nom	l mm	m kg
80	80	0,25
100	100	0,35
125	125	0,48
140	140	0,61
150	150	0,84
160	160	0,86
180	180	1,02
200	200	1,30
224	224	1,33
250	•	•
280	•	•
300	•	•
315	•	•
355	•	•
400	•	•
450	•	•
500	•	•
560	•	•
600	•	•
630	•	•
710	•	•
800	•	•
900	•	•
1000	•	•
1120	•	•
1250	•	•

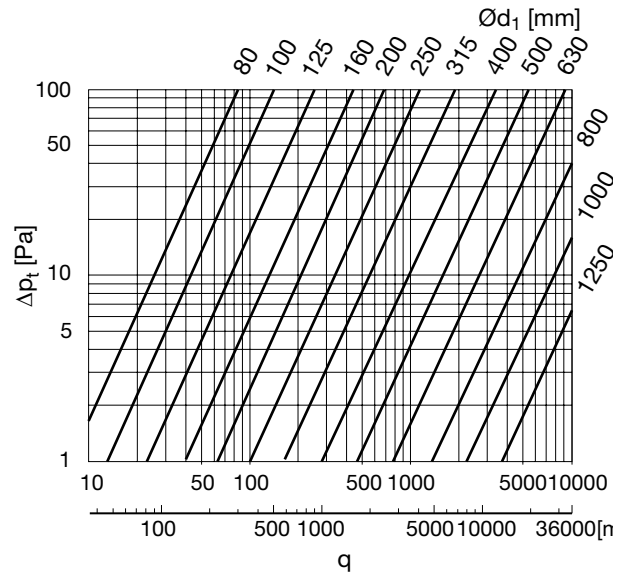

- For more detailed information and measures see datasheet for [BFU 90°](#)

Circular duct system

Bends

BFU 45°, lockseamed bend

Technical data

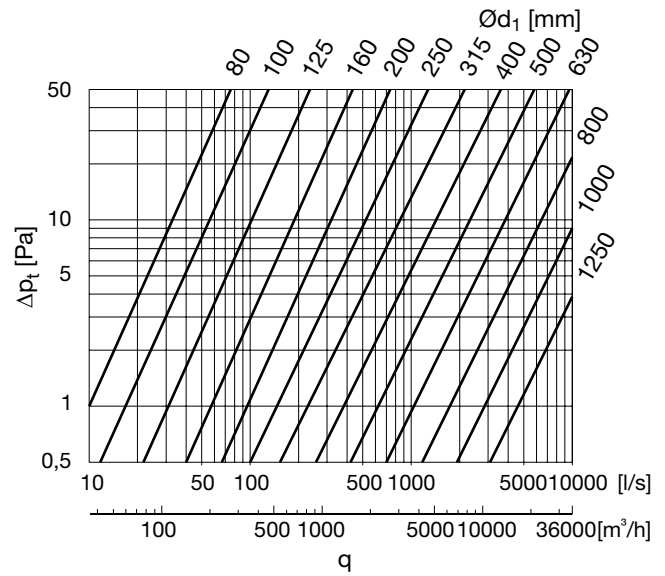
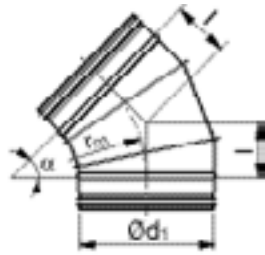

$\text{Ø}d, \text{ nom}$	$l \text{ mm}$	$m \text{ kg}$
80	33	0,17
100	42	0,21
125	52	0,29
140	58	0,42
150	62	0,47
160	66	0,55
180	75	0,64
200	83	0,80
224	93	0,82
250	•	•
280	•	•
300	•	•
315	•	•
355	•	•
400	•	•
450	•	•
500	•	•
560	•	•
600	•	•
630	•	•
710	•	•
800	•	•
900	•	•
1000	•	•
1120	•	•
1250	•	•

- For more detailed information and measures see datasheet for [BFU 45°](#)



Circular duct system

Bends

BFU 60°, lockseamed bend

Technical data

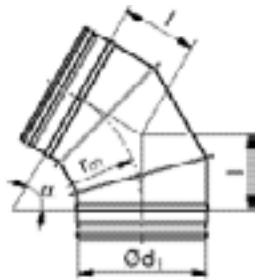

Ød, nom	l mm	m kg
80	46	0,24
100	58	0,33
125	72	0,40
140	81	0,50
150	87	0,58
160	104	0,65
180	92	0,79
200	115	0,95
224	129	0,99
250	•	•
280	•	•
300	•	•
315	•	•
355	•	•
400	•	•
450	•	•
500	•	•
560	•	•
600	•	•
630	•	•
710	•	•
800	•	•
900	•	•
1000	•	•
1120	•	•
1250	•	•

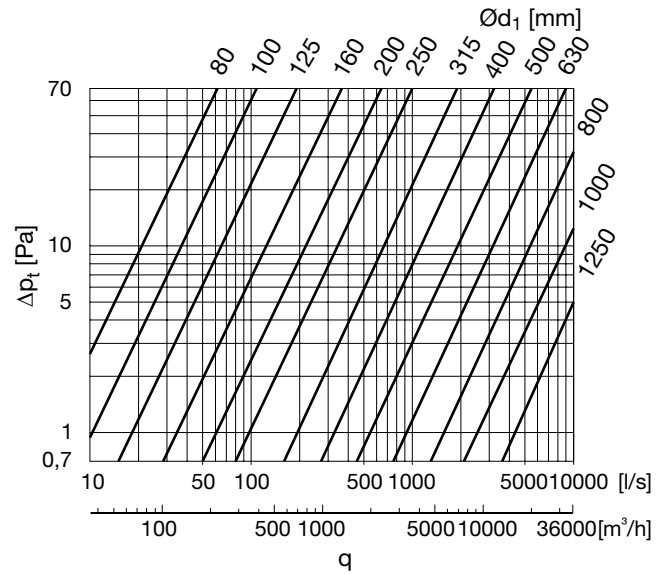

- For more detailed information and measures see datasheet for [BFU 60°](#)

Circular duct system

Bends

BFU 30°, lockseamed bend

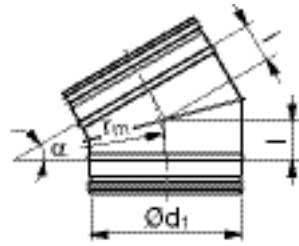

Technical data

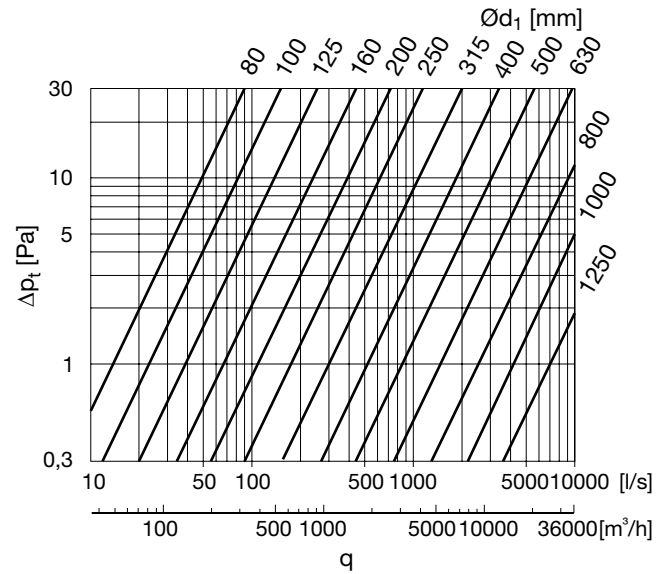

$\text{O}d_{\text{nom}}$	l mm	m kg
80	21	0,16
100	27	0,17
125	34	0,24
140	38	0,30
150	40	0,36
160	48	0,43
180	43	0,51
200	54	0,62
224	60	0,72
250	•	•
280	•	•
300	•	•
315	•	•
355	•	•
400	•	•
450	•	•
500	•	•
560	•	•
600	•	•
630	•	•
710	•	•
800	•	•
900	•	•
1000	•	•
1120	•	•
1250	•	•

- For more detailed information and measures see datasheet for [BFU 30°](#)



Circular duct system

Bends

BFU 15°, lockseamed bend

Technical data

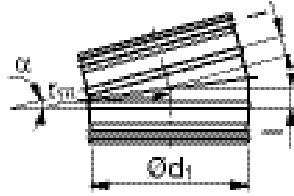

Ød, nom	l mm	m kg
80	11	0,15
100	13	0,15
125	17	0,20
140	18	0,25
150	20	0,31
160	24	0,40
180	21	0,50
200	26	0,60
224	30	0,66
250	•	•
280	•	•
300	•	•
315	•	•
355	•	•
400	•	•
450	•	•
500	•	•
560	•	•
600	•	•
630	•	•
710	•	•
800	•	•
900	•	•
1000	•	•
1120	•	•
1250	•	•

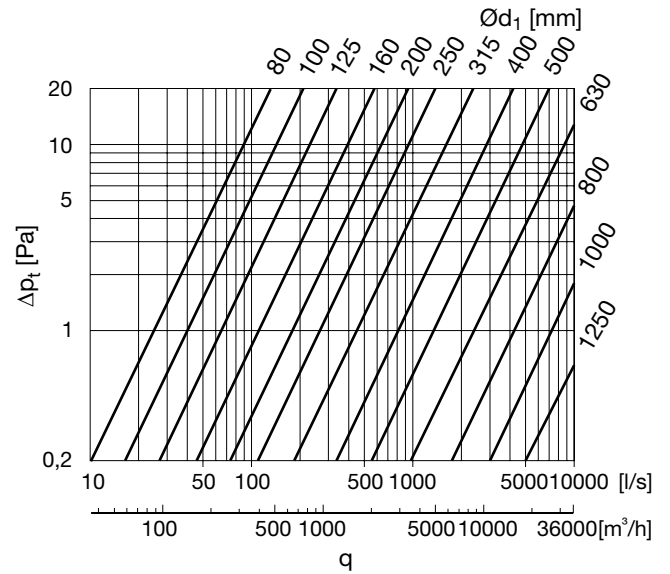

- For more detailed information and measures see datasheet for [BFU 15°](#)



Circular duct system

Bends

BKFU 90°, short, lockseamed bend

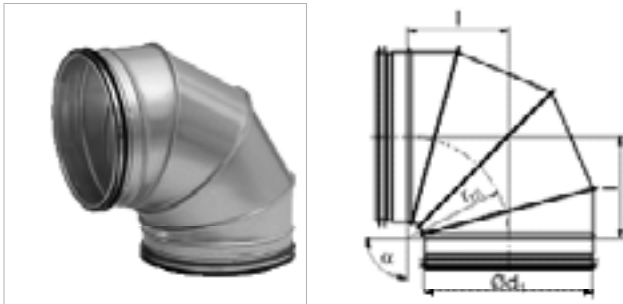

BKFMU 90°, short, segmented bend with female end

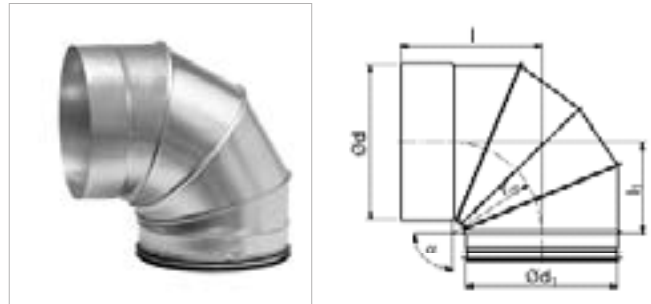

Ød, nom	Comment
100	
125	
160	
200	
250	
315	
355	
400	
500	
630	
710	
800	
1000	
1120	
1250	

Ød, nom	Comment
	For more detailed information about technical data and measures see datasheet for BKFU 90°

Ød, nom	Comment
100	
125	
160	
200	
250	
315	
400	
500	
630	
710	
800	
1000	
1120	
1250	

Ød, nom	Comment
	For more detailed information about technical data and measures see datasheet for BKFMU 90°



Circular duct system

Bends

BKU 90°, short

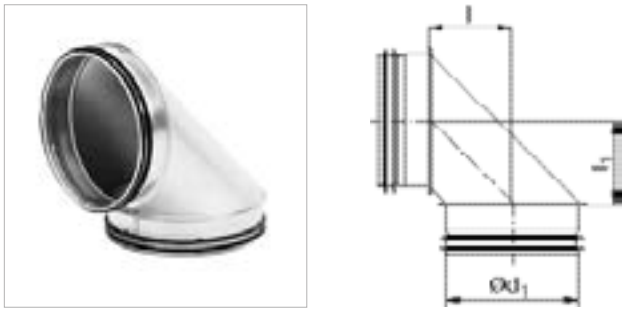

Ød ₁ [nom]	l* [mm]	l ₁ * [mm]	m [kg]
80	55	55	0,14
100	62	62	0,24
125	77	77	0,37
160	94	94	0,54

* Tolerance ±5 mm

BKMU 90°, short with female end

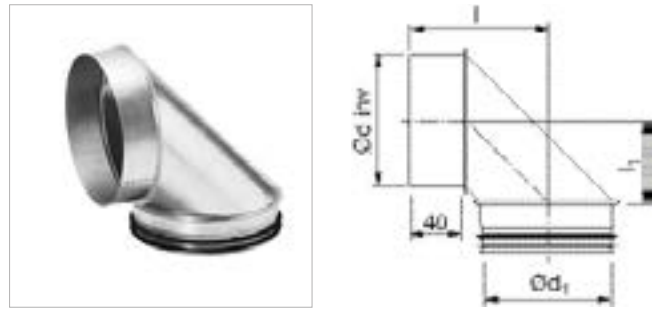

Ød ₁ [nom]	Ød [mm]	l* [mm]	l ₁ * [mm]	m [kg]
80	80	97	55	0,13
100	100	104	62	0,24
125	125	118	77	0,37
160	160	136	94	0,54

* Tolerance ±5 mm

Technical data

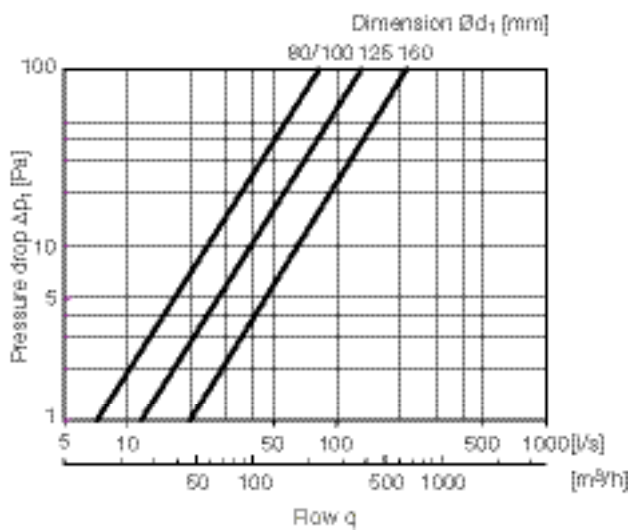

Technical data

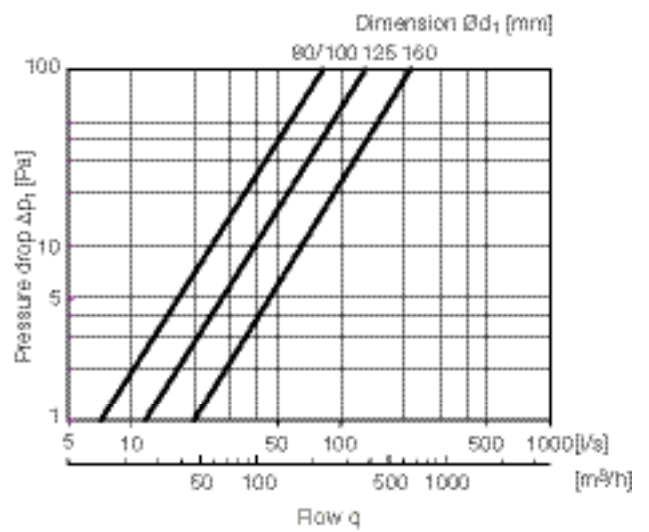

Circular duct system

Bends

BSFU 90°, long, lockseamed bend

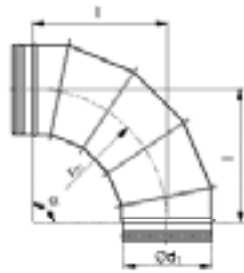

BSFU 45°, long, lockseamed bend

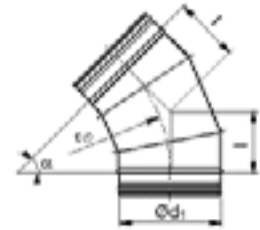

Ød, nom	Comment
250	
280	
300	
315	
355	
400	
450	
500	
560	For more detailed information about technical data and measures see datasheet for BSFU 90°
600	
630	
710	
800	
900	
1000	
1120	
1250	

Ød, nom	Comment
250	
280	
300	
315	
355	
400	
450	
500	
560	For more detailed information about technical data and measures see datasheet for BSFU 45°
600	
630	
710	
800	
900	
1000	
1120	
1250	



Circular duct system

Cleaning bends

BFKCU 90°, cleaning bend

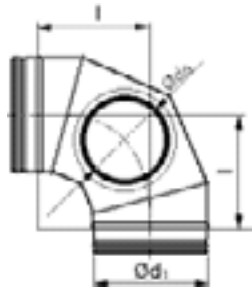

BFBKCU 90°, cleaning bend

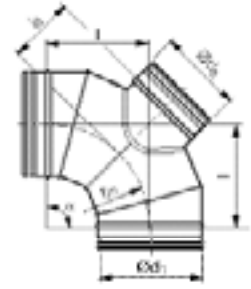

Ød ₁ nom	Ød ₃						
	100	125	160	200	250	315	400
100	•						
112	•						
125	•	•					
140		•					
150		•					
160		•	•				
180			•				
200			•				
224				•			
250				•	•		
300					•		
315					•	•	
400						•	•

Comment: For more detailed information about technical data and measures see datasheet for [BFKCU 90°](#)

- Available dimensions

Ød ₁ nom	Ød ₃						
	100	125	160	200	250	315	400
100	•						
112	•						
125	•	•					
140		•					
160		•	•				
150		•					
180			•				
200			•				
224				•			
250				•	•		
300					•		
315					•	•	
400						•	•

Comment: For more detailed information about technical data and measures see datasheet for [BFBKCU 90°](#)

- Available dimensions

Circular duct system

Reducers

RCU, reducer

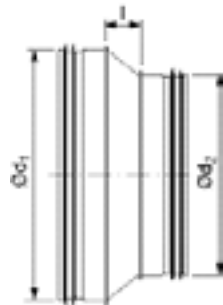

Ød ₁ nom													
	80	100	125	150	160	180	200	224	250	315	400	500	
100	•												
125	•	•											
150		•	•										
160	•	•	•	•									
180		•	•	•	•								
200		•	•	•	•	•							
224				•	•	•	•						
250			•	•	•	•	•	•					
300							•		•				
315					•		•		•				
355									•	•			
400							•		•	•			
500									•	•	•		
630										•	•	•	

Comment: For more detailed information about technical data and measures see datasheet for [RCU](#)

- Available dimensions



Circular duct system

Reducers

RCFU, reducer with female end

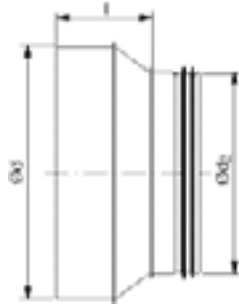

Ød nom													
	80	100	125	150	160	180	200	224	250	315	400	500	
100	•												
125	•	•											
150		•	•										
160		•	•	•									
180		•	•	•	•								
200		•	•	•	•	•							
224				•	•	•	•						
250			•	•	•	•	•	•					
300							•		•				
315					•		•		•				
355									•	•			
400							•		•	•			
500									•	•	•		
630										•	•	•	

Comment: For more detailed information about technical data and measures see datasheet for [RCFU](#)

- Available dimensions

Circular duct system

Reducers

RU, eccentric reducer

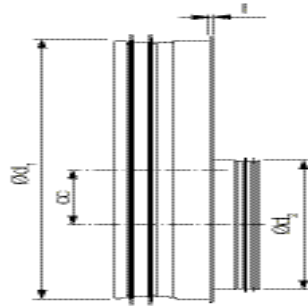

Ød ₁ nom	Ød ₂																	
	200	224	250	280	300	315	355	400	450	500	560	600	630	710	800	900	1000	1120
400	•	•	•	•	•	•	•											
450			•	•	•	•	•	•										
500			•	•	•	•	•	•	•									
560						•	•	•	•	•								
600						•	•	•	•	•	•							
630						•	•	•	•	•	•	•						
710								•	•	•	•	•	•					
800								•	•	•	•	•	•	•				
900										•	•	•	•	•	•			
1000										•	•	•	•	•	•	•		
1120													•	•	•	•	•	
1250													•	•	•	•	•	•

Comment: For more detailed information about technical data and measures see datasheet for [RU](#)

- Available dimensions



Circular duct system

Reducers

RFU, eccentric reducer with female end

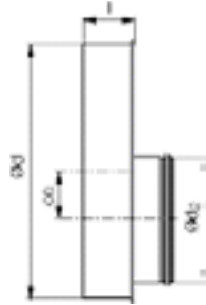

Ød nom	Ød ₂																	
	200	224	250	280	300	315	355	400	450	500	560	600	630	710	800	900	1000	1120
400	•	•	•	•	•	•	•											
450			•	•	•	•	•	•										
500			•	•	•	•	•	•	•									
560						•	•	•	•	•								
600						•	•	•	•	•	•							
630						•	•	•	•	•	•	•						
710								•	•	•	•	•	•					
800								•	•	•	•	•	•	•				
900										•	•	•	•	•	•			
1000										•	•	•	•	•	•	•		
1120													•	•	•	•	•	
1250													•	•	•	•	•	•

Comment: For more detailed information about technical data and measures see datasheet for [RFU](#)

- Available dimensions

Circular duct system

Reducers

RFLU, long, tangential reducer with female end

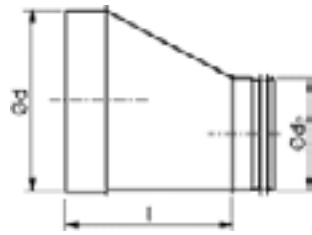

Ød nom																											
	80	100	112	125	140	150	160	180	200	224	250	280	300	315	355	400	450	500	560	600	630	710	800	900	1000	1120	
100	•																										
112	•	•																									
125	•		•																								
140	•		•	•																							
150	•	•	•	•	•																						
160	•	•	•	•	•	•																					
180	•	•	•	•	•	•	•																				
200	•	•	•	•	•	•	•	•																			
224		•	•	•	•	•	•	•	•																		
250		•	•	•	•	•	•	•	•	•																	
280				•	•	•	•	•	•	•	•																
300				•	•	•	•	•	•	•	•	•															
315				•	•	•	•	•	•	•	•	•	•														
355							•	•	•	•	•	•	•	•													
400							•	•	•	•	•	•	•	•	•												
450									•	•	•	•	•	•	•	•											
500									•	•	•	•	•	•	•	•	•										
560											•	•	•	•	•	•	•	•									
600											•	•	•	•	•	•	•	•	•								
630											•	•	•	•	•	•	•	•	•	•							
710															•	•	•	•	•	•	•	•					
800																•	•	•	•	•	•	•	•	•			
900																	•	•	•	•	•	•	•	•	•		
1000																			•	•	•	•	•	•	•	•	
1120																			•	•	•	•	•	•	•	•	•
1250																				•	•	•	•	•	•	•	•

Comment: For more detailed information about technical data and measures see datasheet for [RFLU](#)

- Available dimensions



Circular duct system

Reducers

RCLU, long, concentric reducer

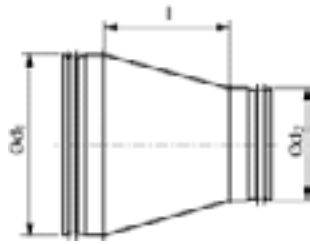

$\varnothing d_1$ nom																										
	80	100	112	125	140	150	160	180	200	224	250	280	300	315	355	400	450	500	560	600	630	710	800	900	1000	1120
100	•																									
112	•	•																								
125			•																							
140	•	•	•	•																						
150	•		•		•																					
160			•		•																					
180	•		•		•																					
200	•		•		•																					
224		•	•	•	•																					
250		•	•		•																					
280				•	•	•	•	•	•	•	•															
300				•	•	•	•	•		•		•														
315				•	•	•		•		•		•	•													
355							•	•	•	•	•	•	•													
400							•	•		•		•	•		•											
450									•	•	•	•	•	•	•	•										
500									•	•	•	•	•		•	•	•									
560											•	•	•	•	•	•	•	•								
600											•	•	•	•	•	•	•	•	•							
630											•	•	•		•	•	•		•	•						
710															•	•	•	•	•	•	•					
800																•	•	•	•	•	•	•	•			
900																	•	•	•	•	•	•	•	•		
1000																		•	•	•	•	•	•	•	•	
1120																			•	•	•	•	•	•	•	•
1250																				•	•	•	•	•	•	•

Comment: For more detailed information about technical data and measures see datasheet for [RCLU](#)

- Available dimensions



Circular duct system

Reducers

RCFLU, long, concentric reducer with female end

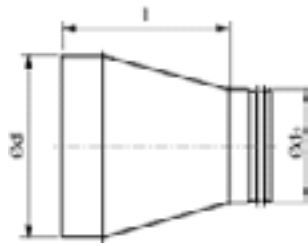

Ød nom																												
	80	100	112	125	140	150	160	180	200	224	250	280	300	315	355	400	450	500	560	600	630	710	800	900	1000	1120		
100	•																											
112	•	•																										
125	•	•	•																									
140	•	•	•	•																								
150	•	•	•	•	•																							
160	•	•	•	•	•	•																						
180	•	•	•	•	•	•	•																					
200	•	•	•	•	•	•	•	•																				
224		•	•	•	•	•	•	•	•																			
250		•	•	•	•	•	•	•	•	•																		
280				•	•	•	•	•	•	•	•																	
300				•	•	•	•	•	•	•	•	•																
315				•	•	•	•	•	•	•	•	•	•															
355							•	•	•	•	•	•	•	•														
400							•	•	•	•	•	•	•	•	•													
450									•	•	•	•	•	•	•	•												
500									•	•	•	•	•	•	•	•	•											
560											•	•	•	•	•	•	•	•										
600											•	•	•	•	•	•	•	•	•									
630											•	•	•	•	•	•	•	•	•	•								
710															•	•	•	•	•	•	•							
800																•	•	•	•	•	•	•						
900																	•	•	•	•	•	•	•					
1000																		•	•	•	•	•	•	•				
1120																			•	•	•	•	•	•	•			
1250																				•	•	•	•	•	•	•	•	

Comment: For more detailed information about technical data and measures see datasheet for [RCFLU](#)

- Available dimensions



Circular duct system

Reducers

RLU, long tangential reducer

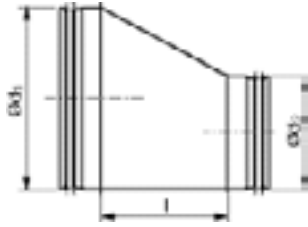

$\varnothing d_1$ nom																											
	80	100	112	125	140	150	160	180	200	224	250	280	300	315	355	400	450	500	560	600	630	710	800	900	1000	1120	
100	•																										
112	•	•																									
125	•	•	•																								
140	•	•	•	•																							
150	•	•	•	•	•																						
160	•	•	•	•	•	•																					
180	•	•	•	•	•	•	•																				
200	•	•	•	•	•	•	•	•																			
224		•	•	•	•	•	•	•	•																		
250		•	•	•	•	•	•	•	•	•																	
280				•	•	•	•	•	•	•	•																
300				•	•	•	•	•	•	•	•	•															
315				•	•	•	•	•	•	•	•	•	•														
355							•	•	•	•	•	•	•	•													
400							•	•	•	•	•	•	•	•	•												
450									•	•	•	•	•	•	•	•											
500									•	•	•	•	•	•	•	•	•										
560										•	•	•	•	•	•	•	•	•									
600										•	•	•	•	•	•	•	•	•	•								
630										•	•	•	•	•	•	•	•	•	•	•							
710															•	•	•	•	•	•	•	•					
800																•	•	•	•	•	•	•	•	•			
900																	•	•	•	•	•	•	•	•	•		
1000																		•	•	•	•	•	•	•	•	•	
1120																			•	•	•	•	•	•	•	•	•
1250																				•	•	•	•	•	•	•	•

Comment: For more detailed information about technical data and measures see datasheet for [RLU](#)

- Available dimensions



Circular duct system

T-pieces

TCU, centric T-piece

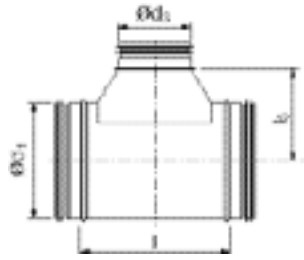

$\varnothing d_1$ nom																											
	80	100	112	125	140	150	160	180	200	224	250	280	300	315	355	400	450	500	560	600	630	710	800	900	1000	1120	1250
80	•*		•	•																							
100	•*	•*	•	•	•	•	•																				
112	•*	•*	•		•	•	•	•																			
125	•*	•*	•*	•*	•	•	•	•	•																		
140	•*	•*	•*	•	•*	•	•	•	•	•																	
150	•*	•*	•	•*	•*	•*		•	•	•	•																
160	•*	•*		•*	•*	•*	•*		•	•	•																
180	•*	•*	•	•*	•*	•*	•*	•*	•	•	•	•															
200	•*	•*	•	•*	•*	•*	•*	•*	•*	•	•	•	•	•													
224	•*	•*	•	•*	•*	•*	•*	•*	•*	•*	•	•	•	•	•												
250	•*	•*	•	•*	•*	•*	•*	•*	•*	•*	•*	•	•	•	•	•											
280	•*	•*	•	•*	•*	•*	•*	•*	•*	•*	•	•	•	•	•	•	•										
300			•						•		•	•	•	•	•	•	•										
315	•*	•*	•	•*			•*		•*		•*			•*	•	•	•	•									
355			•						•		•	•	•	•	•	•	•	•	•								
400		•*	•	•*	•	•	•*	•	•*		•*	•		•*	•	•*	•	•	•	•	•	•					
450		•*		•*	•	•	•*	•	•*	•*	•*	•	•*	•*	•*	•*	•	•	•	•	•	•	•				
500		•*		•*	•	•	•*	•	•*	•	•*	•	•*	•*	•*	•*	•	•	•	•	•	•	•	•			
560		•*		•*			•*		•*	•	•*	•	•*	•*	•*	•*	•	•	•	•	•	•	•	•	•		
600		•*		•*			•*		•*	•	•*	•	•*	•*	•*	•*	•	•	•	•	•	•	•	•	•		
630		•*		•*			•*		•*	•	•*	•	•*	•*	•*	•*	•	•	•	•	•	•	•	•	•	•	
710											•	•	•	•	•	•	•	•	•	•	•	•	•	•	•	•	
800											•	•	•	•	•	•	•	•	•	•	•	•	•	•	•	•	•
900														•	•	•	•	•	•	•	•	•	•	•	•	•	•
1000														•	•	•	•	•	•	•	•	•	•	•	•	•	•
1120																			•	•	•	•	•	•	•	•	•
1250																			•	•	•	•	•	•	•	•	•

Comment: For more detailed information about technical data and measures see datasheet for [TCU](#)

- Available dimensions
- * Only available in Zinc-Magnesium. When made in galvanized this dimension is pressed, see [TCPU](#)



Circular duct system

T-pieces

TU, tangential T-piece

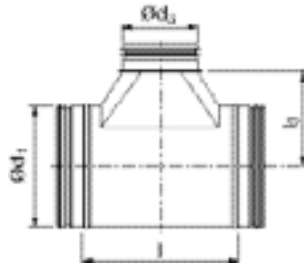

$\varnothing d_1$ nom																											
	80	100	112	125	140	150	160	180	200	224	250	280	300	315	355	400	450	500	560	600	630	710	800	900	1000	1120	1250
80	•	•	•	•																							
100	•	•	•	•	•	•	•																				
112	•	•	•	•	•	•	•	•																			
125	•	•	•	•	•	•	•	•	•																		
140	•	•	•	•	•	•	•	•	•	•																	
150	•	•	•	•	•	•	•	•	•	•	•																
160	•	•	•	•	•	•	•	•	•	•	•	•															
180	•	•	•	•	•	•	•	•	•	•	•	•	•														
200	•	•	•	•	•	•	•	•	•	•	•	•	•	•													
224	•	•	•	•	•	•	•	•	•	•	•	•	•	•	•												
250	•	•	•	•	•	•	•	•	•	•	•	•	•	•	•	•											
280	•	•	•	•	•	•	•	•	•	•	•	•	•	•	•	•	•										
300	•	•	•	•	•	•	•	•	•	•	•	•	•	•	•	•	•										
315	•	•	•	•	•	•	•	•	•	•	•	•	•	•	•	•	•	•									
355		•	•	•	•	•	•	•	•	•	•	•	•	•	•	•	•	•	•								
400		•	•	•	•	•	•	•	•	•	•	•	•	•	•	•	•	•	•	•							
450				•	•	•	•	•	•	•	•	•	•	•	•	•	•	•	•	•	•						
500				•	•	•	•	•	•	•	•	•	•	•	•	•	•	•	•	•	•	•					
560									•	•	•	•	•	•	•	•	•	•	•	•	•	•	•				
600									•	•	•	•	•	•	•	•	•	•	•	•	•	•	•	•			
630									•	•	•	•	•	•	•	•	•	•	•	•	•	•	•	•	•		
710										•	•	•	•	•	•	•	•	•	•	•	•	•	•	•	•	•	
800										•	•	•	•	•	•	•	•	•	•	•	•	•	•	•	•	•	•
900														•	•	•	•	•	•	•	•	•	•	•	•	•	•
1000														•	•	•	•	•	•	•	•	•	•	•	•	•	•
1120																			•	•	•	•	•	•	•	•	•
1250																			•	•	•	•	•	•	•	•	•

Comment: For more detailed information about technical data and measures see datasheet for [TU](#)

- Available dimensions



Circular duct system

T-pieces

TSTCU, centric T-piece

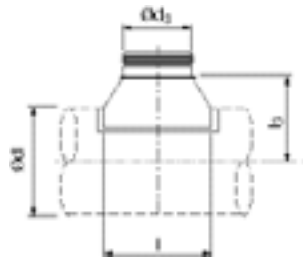

Ød nom																												
	80	100	112	125	140	150	160	180	200	224	250	280	300	315	355	400	450	500	560	600	630	710	800	900	1000	1120	1250	
80	•*	•	•	•																								
100	•*	•*	•	•	•	•	•																					
112			•	•	•	•	•	•																				
125	•*	•*	•	•*	•	•	•	•	•																			
140	•		•			•	•	•	•	•																		
150	•		•				•	•	•	•	•																	
160	•*	•*	•	•*			•*	•	•	•	•																	
180	•		•	•	•	•	•		•	•	•	•																
200	•*	•*	•	•*			•*	•	•*	•	•	•	•	•														
224			•							•	•	•	•	•	•													
250		•*	•	•*			•*	•	•*	•	•	•	•	•	•	•												
280			•							•	•	•	•	•	•	•	•											
300			•							•	•	•	•	•	•	•	•											
315	•*	•*	•	•*			•*	•	•*	•	•	•	•	•*	•	•	•	•	•									
355			•								•	•	•	•	•	•	•	•	•	•								
400		•*	•	•*	•		•*	•	•*	•	•*	•	•	•*	•	•*	•	•	•	•	•	•						
450					•			•			•	•	•		•	•	•	•	•	•	•	•	•					
500					•			•				•	•		•	•	•	•	•	•	•	•	•	•				
560												•	•		•	•	•	•	•	•	•	•	•	•	•			
600												•	•		•	•	•	•	•	•	•	•	•	•	•	•		
630												•	•		•	•	•	•	•	•	•	•	•	•	•	•	•	
710											•	•	•	•	•	•	•	•	•	•	•	•	•	•	•	•	•	•
800											•	•	•	•	•	•	•	•	•	•	•	•	•	•	•	•	•	•
900															•	•	•	•	•	•	•	•	•	•	•	•	•	•
1000															•	•	•	•	•	•	•	•	•	•	•	•	•	•
1120																						•	•	•	•	•	•	•
1250																						•	•	•	•	•	•	•

Comment: For more detailed information about technical data and measures see datasheet for [TSTCU](#)

- Available dimensions
- * Only available in Zinc-Magnesium. When made in galvanized this dimension is pressed, see [TCPU](#)



Circular duct system

T-pieces

TSTU, tangential T-piece

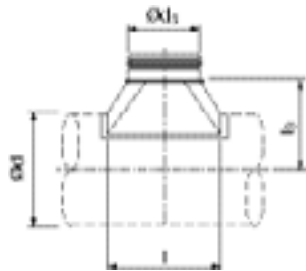

Ød nom																											
	80	100	112	125	140	150	160	180	200	224	250	280	300	315	355	400	450	500	560	600	630	710	800	900	1000	1120	1250
80		•	•	•																							
100	•		•	•	•	•	•																				
112	•	•		•	•	•	•	•																			
125	•	•	•		•	•	•	•	•																		
140	•	•	•	•		•	•	•	•	•																	
150	•	•	•	•	•		•	•	•	•	•																
160	•	•	•	•	•	•		•	•	•	•																
180	•	•	•	•	•	•	•		•	•	•	•															
200	•	•	•	•	•	•	•	•		•	•	•	•														
224	•	•	•	•	•	•	•	•	•		•	•	•	•													
250	•	•	•	•	•	•	•	•	•	•		•	•	•	•												
280	•	•	•	•	•	•	•	•	•	•	•		•	•	•	•											
300	•	•	•	•	•	•	•	•	•	•	•	•		•	•	•	•										
315	•	•	•	•	•	•	•	•	•	•	•	•	•		•	•	•	•									
355		•	•	•	•	•	•	•	•	•	•	•	•	•		•	•	•	•								
400		•	•	•	•	•	•	•	•	•	•	•	•	•	•		•	•	•	•							
450				•	•	•	•	•	•	•	•	•	•	•	•	•		•	•	•	•						
500				•	•	•	•	•	•	•	•	•	•	•	•	•	•		•	•	•	•	•				
560										•	•	•	•	•	•	•	•	•		•	•	•	•	•			
600										•	•	•	•	•	•	•	•	•	•		•	•	•	•	•		
630										•	•	•	•	•	•	•	•	•	•	•		•	•	•	•	•	
710											•	•	•	•	•	•	•	•	•	•	•		•	•	•	•	
800											•	•	•	•	•	•	•	•	•	•	•	•		•	•	•	•
900														•	•	•	•	•	•	•	•	•	•		•	•	•
1000															•	•	•	•	•	•	•	•	•	•		•	•
1120																			•	•	•	•	•	•	•	•	•
1250																			•	•	•	•	•	•	•	•	•

Comment: For more detailed information about technical data and measures see datasheet for [TSTU](#).

- Available dimensions



Circular duct system

X-pieces

XCU, centric X-piece

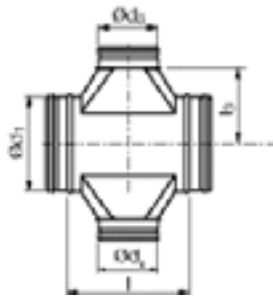

$\varnothing d_1$ nom																												
	80	100	112	125	140	150	160	180	200	224	250	280	300	315	355	400	450	500	560	600	630	710	800	900	1000	1120	1250	
80	•																											
100	•	•																										
112	•	•	•																									
125	•	•	•	•																								
140	•	•	•	•	•																							
150	•	•	•	•	•	•																						
160	•	•	•	•	•	•	•																					
180	•	•	•	•	•	•	•	•																				
200	•	•	•	•	•	•	•	•	•																			
224	•	•	•	•	•	•	•	•	•	•																		
250	•	•	•	•	•	•	•	•	•	•	•																	
280	•	•	•	•	•	•	•	•	•	•	•	•																
300	•	•	•	•	•	•	•	•	•	•	•	•	•															
315	•	•	•	•	•	•	•	•	•	•	•	•	•	•														
355		•	•	•	•	•	•	•	•	•	•	•	•	•	•													
400		•	•	•	•	•	•	•	•	•	•	•	•	•	•	•												
450				•	•	•	•	•	•	•	•	•	•	•	•	•	•											
500				•	•	•	•	•	•	•	•	•	•	•	•	•	•	•										
560									•	•	•	•	•	•	•	•	•	•	•	•								
600									•	•	•	•	•	•	•	•	•	•	•	•	•							
630									•	•	•	•	•	•	•	•	•	•	•	•	•	•						
710											•	•	•	•	•	•	•	•	•	•	•	•	•					
800										•	•	•	•	•	•	•	•	•	•	•	•	•	•	•				
900												•	•	•	•	•	•	•	•	•	•	•	•	•	•			
1000													•	•	•	•	•	•	•	•	•	•	•	•	•	•		
1120																		•	•	•	•	•	•	•	•	•	•	
1250																			•	•	•	•	•	•	•	•	•	•

Comment: For more detailed information about technical data and measures see datasheet for [XCU](#).

- Available dimensions



Circular duct system

X-pieces

XU, tangential X-piece

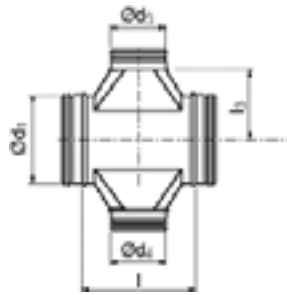

$\varnothing d_1$ nom																										
	80	100	112	125	140	150	160	180	200	224	250	280	300	315	355	400	450	500	560	600	630	710	800	900	1000	1120
80																										
100	•																									
112	•	•																								
125	•	•	•																							
140	•	•	•	•																						
150	•	•	•	•	•																					
160	•	•	•	•	•	•																				
180	•	•	•	•	•	•	•																			
200	•	•	•	•	•	•	•	•																		
224	•	•	•	•	•	•	•	•	•																	
250	•	•	•	•	•	•	•	•	•	•																
280	•	•	•	•	•	•	•	•	•	•	•															
300	•	•	•	•	•	•	•	•	•	•	•	•														
315	•	•	•	•	•	•	•	•	•	•	•	•	•													
355		•	•	•	•	•	•	•	•	•	•	•	•	•												
400		•	•	•	•	•	•	•	•	•	•	•	•	•	•											
450				•	•	•	•	•	•	•	•	•	•	•	•	•										
500				•	•	•	•	•	•	•	•	•	•	•	•	•	•									
560									•	•	•	•	•	•	•	•	•	•								
600									•	•	•	•	•	•	•	•	•	•	•							
630									•	•	•	•	•	•	•	•	•	•	•	•						
710											•	•	•	•	•	•	•	•	•	•	•					
800											•	•	•	•	•	•	•	•	•	•	•	•				
900													•	•	•	•	•	•	•	•	•	•	•			
1000														•	•	•	•	•	•	•	•	•	•	•		
1120																		•	•	•	•	•	•	•	•	•
1250																		•	•	•	•	•	•	•	•	•

Comment: For more detailed information about technical data and measures see datasheet for [XU](#).

- Available dimensions



Circular duct system

Take-offs

ILU, take-off without radius



ILF, take-off without radius with female end

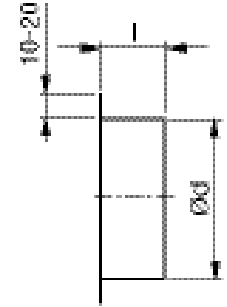

Ød, nom	Comment
80	
100	
112	
125	
140	
150	
160	
180	
200	
224	
250	
280	
300	
315	For more detailed information about technical data and measures see datasheet for ILU .
355	
400	
450	
500	
560	
600	
630	
710	
800	
900	
1000	
1120	
1250	

Ød nom	Comment
80	
100	
112	
125	
140	
150	
160	
180	
200	
224	
250	
280	
300	
315	For more detailed information about technical data and measures see datasheet for ILF .
355	
400	
450	
500	
560	
600	
630	
710	
800	
900	
1000	
1120	
1250	



Circular duct system

Take-offs

ESNU, take-off with mesh

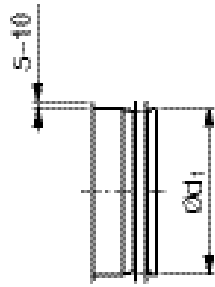

EPNF, take-off with mesh and female end

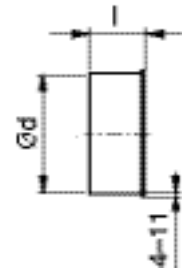

Ød, nom	Comment
80	
100	
112	
125	
140	
150	
160	
180	
200	
224	
250	
280	
300	
315	
355	
400	
450	
500	
560	
600	
630	
710	
800	
900	
1000	
1120	
1250	

For more detailed information about technical data and measures see datasheet for [ESNU](#).

Ød nom	Comment
80	
100	
112	
125	
140	
150	
160	
180	
200	
224	
250	
280	
300	
315	
355	
400	
450	
500	
560	
600	
630	
710	
800	
900	
1000	
1120	
1250	

For more detailed information about technical data and measures see datasheet for [EPNF](#).

Circular duct system

Take-offs

ILKNU 50, take-off with mesh and cone

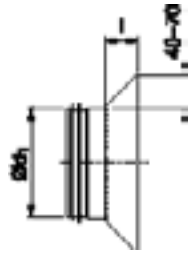

ILKNU 100, take-off with mesh and cone

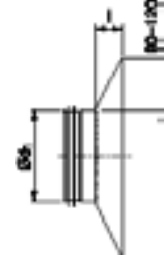

Ød, nom	Comment
80	
100	
125	
160	
200	
250	For more detailed information about technical data and measures see datasheet for ILKNU 50 .
315	
400	
500	
630	
800	

Ød, nom	Comment
80	
100	
125	
160	
200	
250	For more detailed information about technical data and measures see datasheet for ILKNU 100 .
315	
400	
500	
630	
800	

ILKNF 50, take-off with mesh, cone and female end

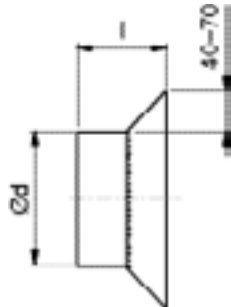

ILKNF 100, take-off with mesh, cone and female end



Ød, nom	Comment
100	
125	
160	
200	
250	For more detailed information about technical data and measures see datasheet for ILKNF 50 .
315	
400	
500	
630	
800	

Ød, nom	Comment
100	
125	
160	
200	
250	For more detailed information about technical data and measures see datasheet for ILKNF 100 .
315	
400	
500	
630	
800	

Circular duct system

Couplings

NPU, coupling

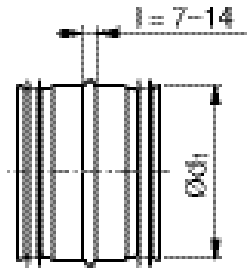

SNPU, slide-in coupling

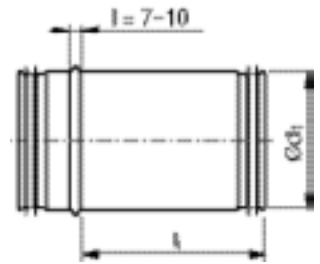

Ød, nom	Comment
80	
100	
112	
125	
140	
150	
160	
180	
200	
224	
250	
280	
300	For more detailed information about technical data and measures see datasheet for NPU .
315	
355	
400	
450	
500	
560	
600	
630	
710	
800	
900	
1000	
1120	
1250	

Ød, nom	Comment
80	
100	
112	
125	
140	
150	
160	
180	
200	
224	All dimensions available in nominal lengths 150 mm, 300 mm and 500 mm.
250	
280	
300	For more detailed information about technical data and measures see datasheet for SNPU .
315	
355	
400	
450	
500	
560	
630	
800	
1000	
1250	



Circular duct system

Couplings

MF, female coupling

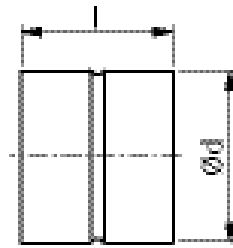

SMFU, slide-in female coupling

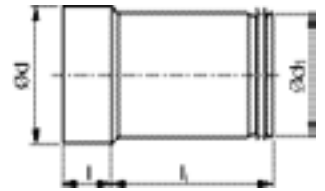

Ød nom	Comment
80	
100	
112	
125	
140	
150	
160	
180	
200	
224	
250	
280	
300	
315	
355	
400	
450	
500	
560	
600	
630	
710	
800	
900	
1000	
1120	
1250	

Ød nom	Comment
80	For more detailed information about technical data and measures see datasheet for MF .
100	
112	
125	
140	
150	
160	
180	
200	
224	
250	
280	
300	
315	
355	
400	
450	
500	
560	
600	
630	
710	
800	
900	
1000	
1120	
1250	

Ød ₁ nom	l mm	Comment
80	150, 300 or 500	For more detailed information about technical data and measures see datasheet for SMFU .
100		
112		
125		
140		
150		
160		
180		
200		
224		
250		
280		
300		
315		
355		
400	300 or 500	
450		
500		
560		
630		
800	500	
1000		
1250		



Circular duct system

End caps

EPF, end cap



ESU, end cap

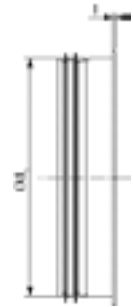

Ød nom	Comment
80	
100	
112	
125	
140	
150	
160	
180	
200	
224	
250	
280	
300	
315	For more detailed information about technical data and measures see datasheet for EPF .
355	
400	
450	
500	
560	
600	
630	
710	
800	
900	
1000	
1120	
1250	

Ød, nom	Comment
80	
100	
112	
125	
140	
150	
160	
180	
200	
224	
250	
280	
300	
315	For more detailed information about technical data and measures see datasheet for ESU .
355	
400	
450	
500	
560	
600	
630	
710	
800	
900	
1000	
1120	
1250	

Circular duct system

Access doors

EPFH, access door

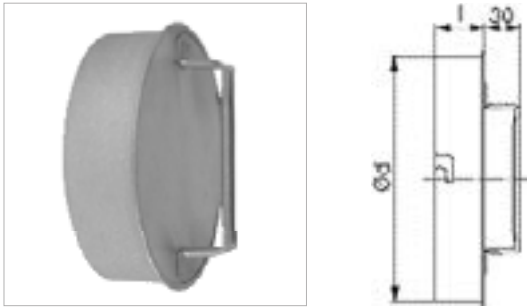

Ød nom	Comment
80	
100	
112	
125	
140	
150	
160	
180	
200	
224	
250	
280	
300	
315	
355	
400	
450	
500	
630	

For more detailed information about technical data and measures see datasheet for [EPFH](#).

ESHU, access door



Ød, nom	Comment
80	
100	
112	
125	
140	
150	
160	
180	
200	
224	
250	
280	
300	
315	
355	
400	
450	
500	
630	

For more detailed information about technical data and measures see datasheet for [ESHU](#).

KCU, insulated access door



Ød nom	l	Insulation thickness	Comment
100	58	50	
125	58	50	
160	58	50	
200	58	50	
250	58	50	
315	58	50	
400	94	50	
500	94	50	
630	94	50	

For more detailed information about technical data and measures see datasheet for [KCU](#).

Circular duct system

Dampers

DRU, regulating damper

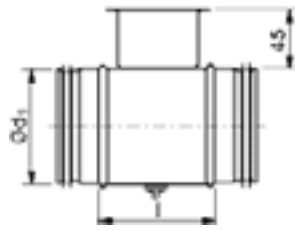

DSU, shut-off damper

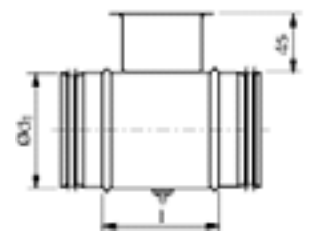

Ød, nom	Comment
80	
100	
112	
125	
140	
150	
160	
180	
200	
224	
250	For more detailed information about technical data and measures see datasheet for DRU .
280	
300	
315	
355	
400	
450	
500	
560	
600	
630	

Ød, nom	Comment
80	
100	
112	
125	
140	
150	
160	
180	
200	
224	
250	For more detailed information about technical data and measures see datasheet for DSU .
280	
300	
315	
355	
400	
450	
500	
560	
600	
630	

Circular duct system

Dampers

DTU, shut-off damper

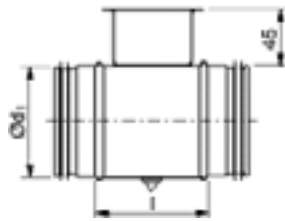

DTHU, shut-off damper with motor shelf

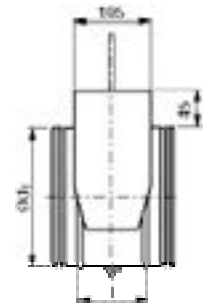

Ød, nom	Comment
80	
100	
112	
125	
140	
150	
160	
180	
200	
224	
250	For more detailed information about technical data and measures see datasheet for DTU .
280	
300	
315	
355	
400	
450	
500	
560	
600	
630	

Ød, nom	Comment
80	
100	
112	
125	
140	
150	
160	
180	
200	
224	
250	For more detailed information about technical data and measures see datasheet for DTHU .
280	
300	
315	
355	
400	
450	
500	
560	
600	
630	

Duct suspension and support system

MDH, duct holder

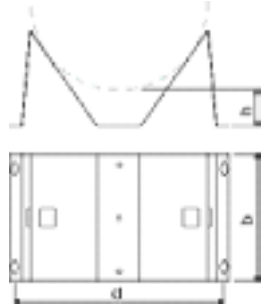

DH, duct holder

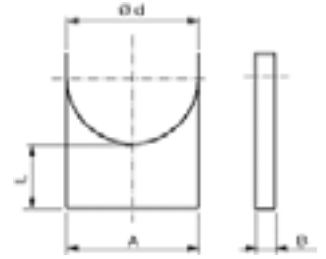

Ød nom	Comment
100	
112	
125	
140	
150	
160	
180	
200	
224	
250	For more detailed information about technical data and measures see datasheet for MDH .
280	
300	
315	
355	
400	
450	
500	
560	
600	
630	

Ød nom	Comment
80	
100	
125	
160	
200	For more detailed information about technical data and measures see datasheet for DH .
250	
315	
400	
500	
630	

Duct suspension and support system

UV30, suspension rings

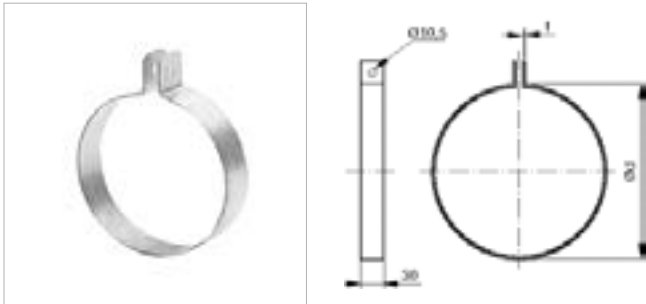

Ød nom	Comment
80	For more detailed information about technical data and measures see datasheet for UV30 .
100	
125	
160	
200	
250	
315	
400	
500	
630	
800	
1000	
1250	

UVH30, suspension rings

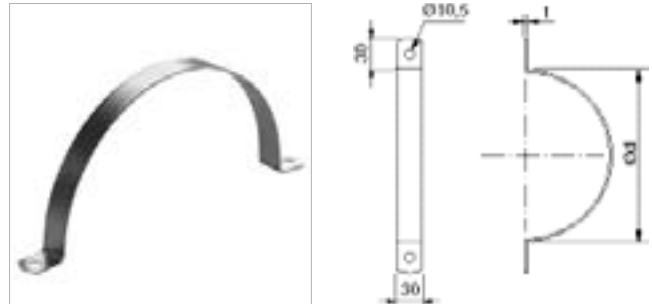

Ød nom	Comment
100	For more detailed information about technical data and measures see datasheet for UVH30 .
125	
160	
200	
250	
315	
400	
500	
630	
800	
1000	
1250	

Fasteners

Blind rivet, pressure-tight

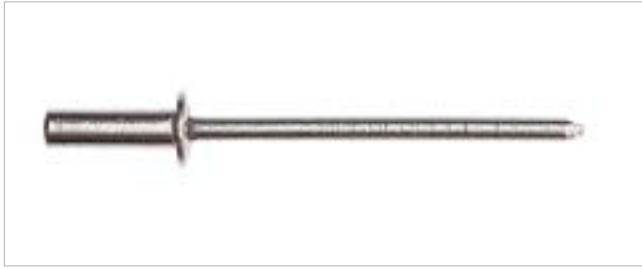

Type	Comment
RH13	For more detailed information about technical data and measures see technical information for RH
RH22	
RH31	
RH33	

Blind rivet, open



Type	Comment
RE12	For more detailed information about technical data and measures see technical information for RE
RE13	
RE14	
RE22	
RE24	

Drill screw, hexagon head



Type	Comment
TG10	For more detailed information about technical data and measures see technical information for TG
TG12	

Drill screw, convex head



Type	Comment
SH11	For more detailed information about technical data and measures see technical information for SH
SH12	



Most of us spend the majority of our time indoors. Indoor climate is crucial to how we feel, how productive we are and if we stay healthy.

We at Lindab have therefore made it our most important objective to contribute to an indoor climate that improves people's lives. We do this by developing energy-efficient ventilation solutions and durable building products. We also aim to contribute to a better climate for our planet by working in a way that is sustainable for both people and the environment.

[Lindab | For a better climate](#)