



# Lindab **Fasadium**

Facade system



# Facade system

# Fasadium



## Use

Lindab's facade system Fasadium is an efficient system designed for ventilation, cooling and heating from the facade. Typical environments where Fasadium is used include, for example, schools, hospitals and offices.

Fasadium can be supplied with valves, flexible pipe connections and a connection card for the Regula Connect control system. Additional plus features that can be integrated into Fasadium include, for example, Regula Combi and the Regula Secura condensation guard.

## Installation

Fasadium is placed along the facade, behind built-in window sills.

## Worth noting

Fasadium is developed for an operating pressure of up to 300 Pa. Fasadium utilises counter-flow heat exchange. The system is provided with a service hatch, which provides full access to the whole battery and helps maintain good hygiene.

Lindab's active chilled beams are Eurovent-certified and tested according to EN-15116.

## Key figures



Length:	600, 700, 800, 1000, 1200, 1500 mm
Height:	540 - 640 mm
Depth:	240 mm
Capacity:	1290 W

## Calculation setup

Room temp: 25°C, Water temp: 14-17°C, Air temp: 18°C,  
Nozzle air pressure: 150 Pa, Air flow: 40 l/s.

# Facade system

# Fasadium

## Function

Fasadium is a facade system with heating, cooling and ventilation functions. Fasadium uses the supply air's driving power, which through induction creates a flow of air through the battery, thereby ejecting cooled or heated air from the system (see picture 1).

On the water side, the individual room temperature is controlled by an electronic control system, Regula Combi, with the heating and cooling in sequence. The control feature ensures that the heating and cooling are not activated at the same time.

Fasadium provides high cooling effects at operating pressures of 60 to 300 Pa. Additional functions include a condensation guard, Regula Secura, which prevents condensation formation, and a service hatch that provides the maximum accessibility to the battery for cleaning and inspection.

## Design

Fasadium's technical design provides the maximum output. The heating and cooling battery is installed to ensure counter-flow heat exchange between the incoming room air and the cooling water in the battery.

This technical solution provides high cooling effects, while allowing the supply cooling water temperature to be kept low, without condensation problems.

Fasadium's end plates, sides and air duct are made from galvanized sheet steel. A service hatch is located on the front edge of the system. All of the heating and cooling battery is accessible for cleaning from both sides through this service hatch. When open, it also provides access to all the ventilation duct's intake nozzles.

The battery has separate circuits for cooling and heating water. The circuits are made from copper pipe that has been expanded mechanically to ensure contact with the aluminium ribs. The battery is mounted horizontally and is easily accessible for cleaning. The cooling feed pipe is insulated against condensation.

To protect the system further against condensation, a condensation guard can be installed. The condensation guard provides significantly increased security against condensation. The Regula Secura condensation guard is positioned next to the battery to detect the formation of moisture. If condensation does form, the cooling water circuit valve closes to prevent it. Then, it re-opens to detect what output can be achieved without condensation forming.

The water pipes are made of copper. Nevertheless, the water should be oxygen-free to prevent corrosion.

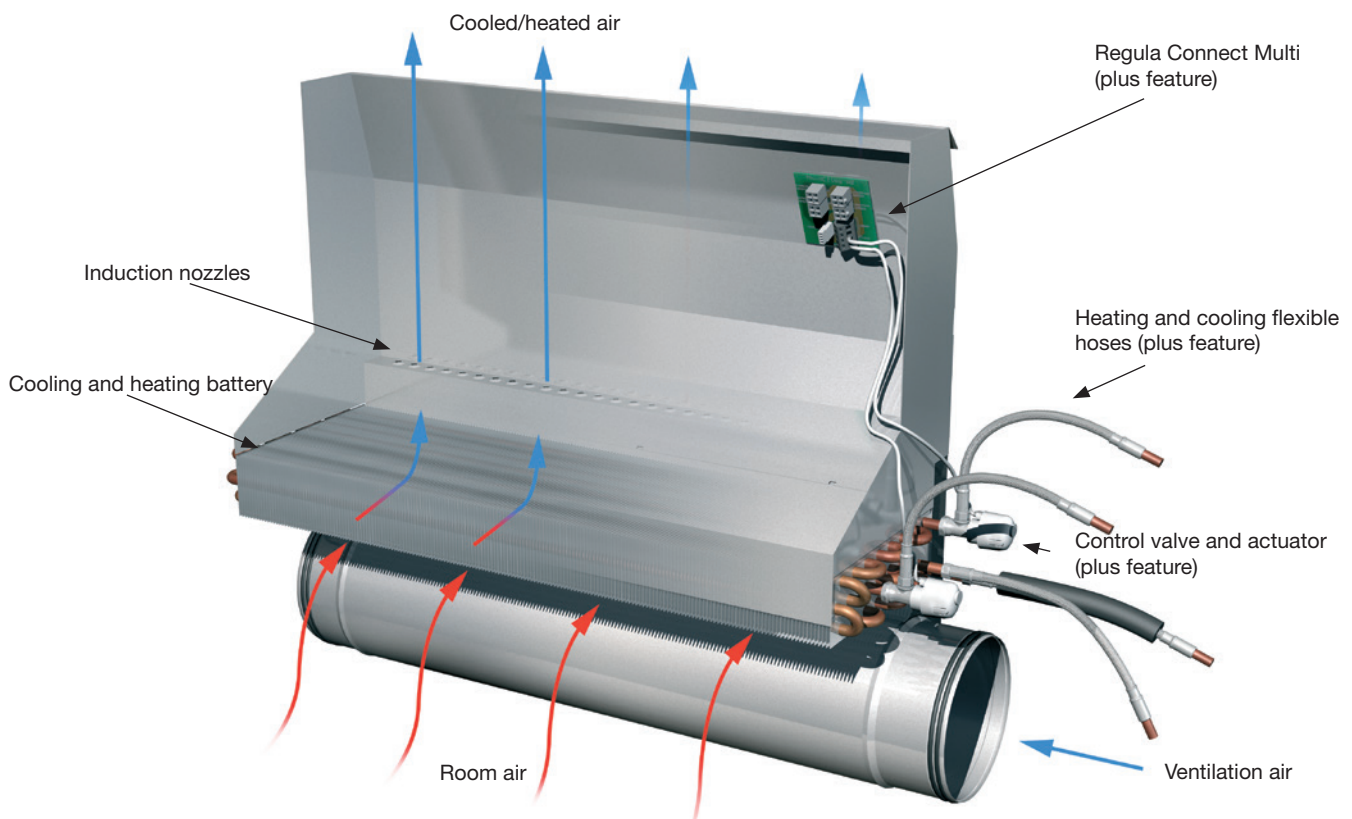

Picture 1. Fasadium uses the supply air's driving power, which through induction creates an air flow through the battery, thereby ejecting cooled or heated air from the system.

# Facade system

## Hygiene

Fasadium is designed for easy cleaning and service. The service hatch provides unrestricted access to the system's battery both from above and below.

On delivery, the system's battery is shielded with protective wrapping and the outlet with protective tape. This prevents dust and dirt from getting into the system before it is put into operation.



Picture 2. Cleaning is easy with the service hatch on the front.

# Fasadium

## Initial settings

The facade system is supplied with the ordered airflow at a given air pressure. On-site adjustment is therefore not required. If necessary, the airflow can be adjusted on site.



Picture 3. Fasadium installed with columns.



Picture 4. Fasadium installed without columns.

# Facade system

# Fasadium

## Casing suggestions

Lindab supplies the facade system without casing. Below are suggestions for three types of casing with different types of wood.

When Fasadium is installed with columns, the whole system is moved away from the facade so the piping and trunking pass in front of the column, see figure 1.

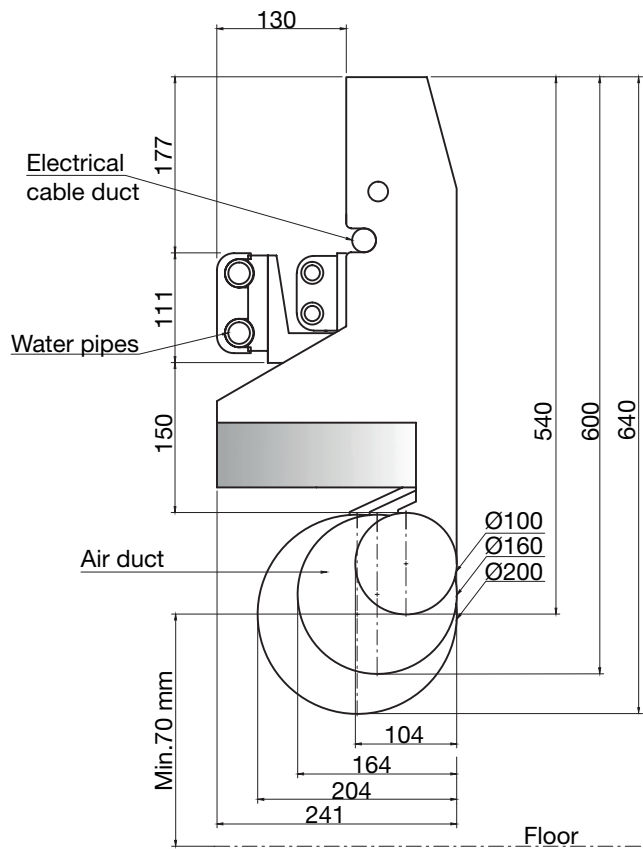

Figure 1. Measurements for Fasadium, with a view to adjusting the casing.



Picture 5. Casing with a worktop fitted with a hatch that is lifted to provide access.



Picture 6. Casing with fixed worktop and detachable hatch on front side.



Picture 7. Casing with fixed worktop and visible electrical cable duct.

# Facade system

# Fasadium

## Control system

The room temperature control system with its pre-fabricated cabling is easy to adapt to varying room sizes and to changes in the room divisions. Operating voltage 24V AC (see picture 8).

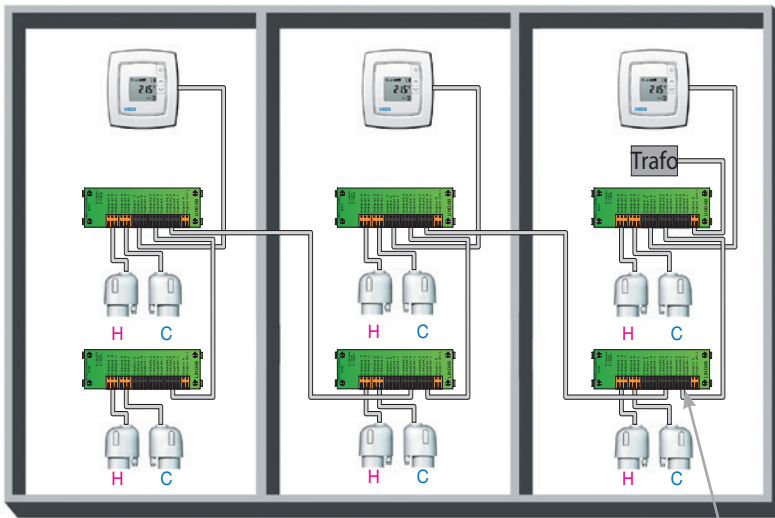

Picture 8. When existing partition walls are moved, the control system can be reconnected.

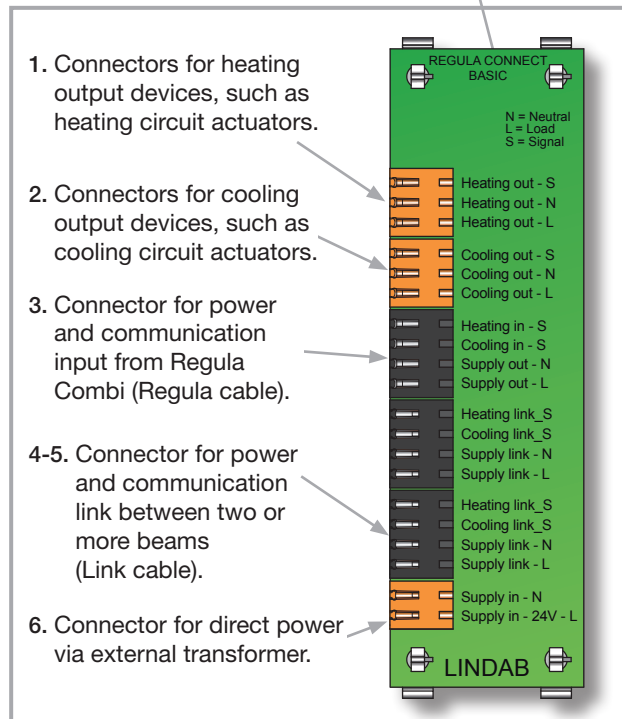

Picture 9. Regula Connect Basic.

# Facade system

# Fasadium

## Fasadium grilles

Galea is the name of Lindab's new grilles for Fasadium. The grilles have arched ribs for the optimum air distribution.

Galea is placed in the casings for Fasadium and is made from aluminium.

The grilles are available in lengths from 600 to 1500 mm. They are available in two colours, white-coated and natural-anodised.

Designation	Size
Galea grill 600, nature	dim: 475x75 mm
Galea grill 700, nature	dim: 575x75 mm
Galea grill 800, nature	dim: 675x75 mm
Galea grill 1000, nature	dim: 875x75 mm
Galea grill 1200, nature	dim: 1075x75 mm
Galea grill 1500, nature	dim: 1375x75 mm
Galea grill 600, RAL 9003	dim: 475x75 mm
Galea grill 700, RAL 9003	dim: 575x75 mm
Galea grill 800, RAL 9003	dim: 675x75 mm
Galea grill 1000, RAL 9003	dim: 875x75 mm
Galea grill 1200, RAL 9003	dim: 1075x75 mm
Galea grill 1500, RAL 9003	dim: 1375x75 mm
Galea grill 600, RAL 9010	dim: 475x75 mm
Galea grill 700, RAL 9010	dim: 575x75 mm
Galea grill 800, RAL 9010	dim: 675x75 mm
Galea grill 1000, RAL 9010	dim: 875x75 mm
Galea grill 1200, RAL 9010	dim: 1075x75 mm
Galea grill 1500, RAL 9010	dim: 1375x75 mm

Table 1. Fasadium grilles.

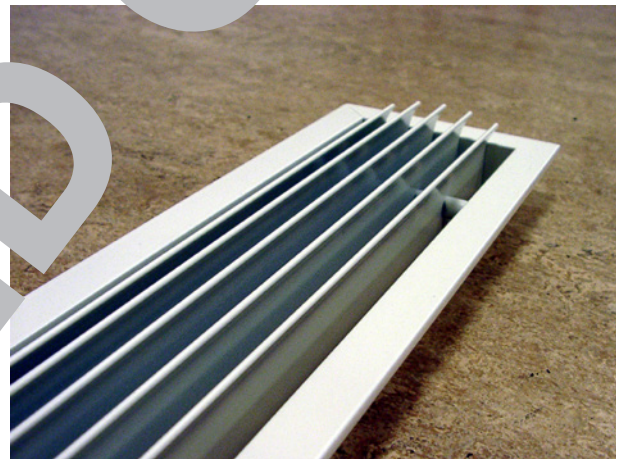

Picture 10a. Fasadium grilles.



Picture 10b. Fasadium grilles.

# Facade system

# Fasadium

## Data



## Fasadium

Fasadium is to be placed along the facade, behind built-in window sills, and it is as standard prepared for ventilation, cooling and heating (4-pipe connection).

**Length:** Fasadium is available in: 600, 700, 800, 1000, 1200, 1500 mm.

**Depth:** The depth is always 240 mm.

**Height:** The Fasadium height is 540 - 640 mm.

**Heating:** The product is standardly equipped with an additional water circuit in the battery to provide a heating function.

**Water connection:** The cooling and heating water connections for Fasadium are made of 12 mm copper pipes (always 4-pipe!).

**Air connection:** Fasadium is supplied with a air connection 125, 160 or 200 mm with Lindab Safe® ducts.

**Design:** Fasadium is delivered without any additional casing to be ready for facade integration.

**Surface treatment:** Fasadium is manufactured as standard from galvanised sheet metal.

## Colour

The Fasadium comes without colour.

## Plus features

Factory preinstalled.

**Enclosed valve and actuator:** A control valve, with variable Kv value, and an actuator can be delivered with the product (when heating is needed, two sets of actuators and valves are needed).

**Integrated Regula Secura:** Lindab's Regula Secura condensation protection can be installed in the product.

Please see "[Regula Secura](#)".

**Integrated Regula Connect:** The product can be equipped with the Regula Connect connection card.

Please see "[Regula Connect](#)".

**Integrated regulation unit:** It is possible to have Lindab's room controller Regula Combi, pre-installed in the product.

Please see "[Regula Combi](#)".

## Accessories

Delivered separately.

**Fasadium outlet front grilles:** Remember to order the grilles: Galea (see page 7 for description).

**Telescope:** For a smart connection to the outlet grill and as an outlet extension, telescopes 50-90 mm, 90-130 mm and 130-250 mm are available.

**Flexible hoses:** A fast and easy way to connect the water circuit. To ensure a fast and simple connection to the water circuit, our flexible hoses can be pre-installed. As our flexible hoses are delivered with push-on connections, a simple and fast workflow during commissioning is ensured. Flexible hoses also contributes to cancelling out vibrations that may occur in a water pipe system.

For additional accessories please refer to the "[Accessories](#)" document on [www.lindQST.com](http://www.lindQST.com).



# Facade system

# Fasadium

## Dimensioning

For easy calculation please go to: Lindabs Quick Selection Tool on [www.lindqst.com](http://www.lindqst.com).

### Cooling capacity air $P_a$

1. Start by calculating the capacity required for the room, to keep a certain temperature. Lindab's TEKNOsim is an excellent tool for this.
2. Calculate which cooling capacity, or read in diagram 1, that is supplied by the ventilation air
3. Remaining cooling capacity needs to be cooled by the water circuit in Fasadium.

The formula for calculating the capacity of the air:

$$P_a = q_{ma} \times c_{pa} \times \Delta t_{ra}$$

Size comparison by  $t_r = 25^\circ\text{C}$  with:

$q_a$  = Primary air flow rate

$$P_a [\text{W}] = q_a [\text{l/s}] \times 1.2 \Delta t_{ra} [\text{K}] \text{ and}$$

$$P_a [\text{W}] = q_a [\text{m}^3/\text{h}] \times 0.33 \Delta t_{ra} [\text{K}]$$

### Definitions:

$P_a$  = Cooling capacity air [W]

$P_w$  = Cooling capacity water [W]

$P_{tot}$  = Cooling capacity total [W]

$q_{ma}$  = Air mass flow rate [kg/s]

$q_a$  = Primary air flow rate [l/s]

$q_w$  = Water flow rate [l/s]

$q_{wmin}$  = Minimal water flow rate [l/s]

$q_{wnom}$  = Nominal water flow rate [l/s]

$c_{pa}$  = Specific heat capacity air [1.004 kJ/kg K]

$t_r$  = Room air temperature [ $^\circ\text{C}$ ]

$t_{wi}$  = Water inlet temperature [ $^\circ\text{C}$ ]

$t_{wo}$  = Water outlet temperature [ $^\circ\text{C}$ ]

$\Delta t_{ra}$  = Temp. diff., room air and primary air temp. [K]

$\Delta t_{rw}$  = Temp. diff., room air and mean water temp. [K]

$\Delta t_w$  = Temp. diff. water circuit [K]

$\varepsilon_{\Delta tw}$  = Capacity correction for temperature

$\varepsilon_{q_w}$  = Capacity correction for water flow

$P_{Lt}$  = Specific cooling capacity [W/(m K)]

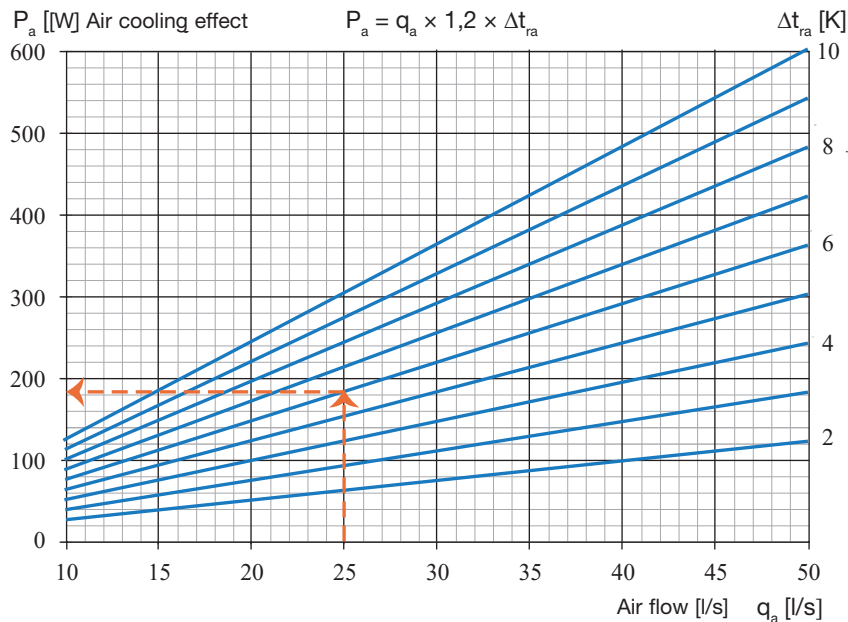

Diagram 1. Cooling capacity air  $P_a$  as function of the primary air flow rate  $q_a$ . If the air supply flow is 25 l/s and the temperature difference of the room air and the supply air is  $\Delta t_{ra} = 6$  K, then the Cooling capacity of the air is 180 W.

# Facade system

# Fasadium

## Dimensioning

For easy calculation please go to: Lindabs Quick Selection Tool on [www.lindQST.com](http://www.lindQST.com).

### Cooling capacity water $P_w$

Follow the instructions below to read off the effect from the diagram.

1. Calculate  $\Delta t_{rw}$ .
2. Product length L minus 0.2 m, to obtain the active length  $L_{act}$ .
3. Divide the primary air flow rate  $q_a$  by the active length  $L_{act}$ . Enter the result on the lower axis of diagram 2 and 3.
4. Follow the flow line to the right pressure, and then read off the specific cooling capacity  $P_{Lt}$  per active metre.
5. Calculate the temperature difference in water circuit  $\Delta t_w$  and find the capacity correction factor  $\epsilon_{\Delta tw}$  in diagram 4.
6. Multiply the specific cooling capacity  $P_{Lt}$  that was read off by  $\epsilon_{\Delta tw}$ ,  $\Delta t_w$  and active length  $L_{act}$ .

### Example 1 Cooling:

What is the cooling capacity of Fasadium 1000 with 14 l/s and pressure of 150 Pa?

The room's summer temperature is assumed to be 24.5°C. The cooling water temperature in/out of Fasadium is 14/17°C.

### Answer:

Temperature difference:

$$\Delta t_{rw} = t_r - (t_{wi} + t_{wo}) / 2$$

$$\Delta t_{rw} = 24.5 - (14 + 17) / 2 = 9 \text{ K}$$

Active length:

$$L_{act} = 1.0 \text{ m} - 0.2 \text{ m} = 0.8 \text{ m}$$

$$q_a / L_{act} = 14 \text{ l/s} / 0.8 \text{ m} = 17.5 \text{ l/(s m)}$$

Read off, from diagram 2:  $P_{Lt} = 60.1 \text{ W/(m K)}$

Diagram 4 shows a capacity correction factor  $\epsilon_{\Delta tw} = 0.968$ .

This gives a cooling capacity:

$$P_w = 60.1 \text{ W/(m K)} \times 9 \text{ K} \times 0.8 \times 0.968 = 419 \text{ W in the water circuit.}$$

**NB!** The capacity diagram applies for the nominal water flow of  $q_{wnom} = 0.038 \text{ l/s}$ . To obtain the right cooling capacity  $P_w$  for other flows, read off the capacity correction factor  $\epsilon_{qw}$  from diagram 5, and then multiply the capacity, which is read off, by this factor.

# Facade system

# Fasadium

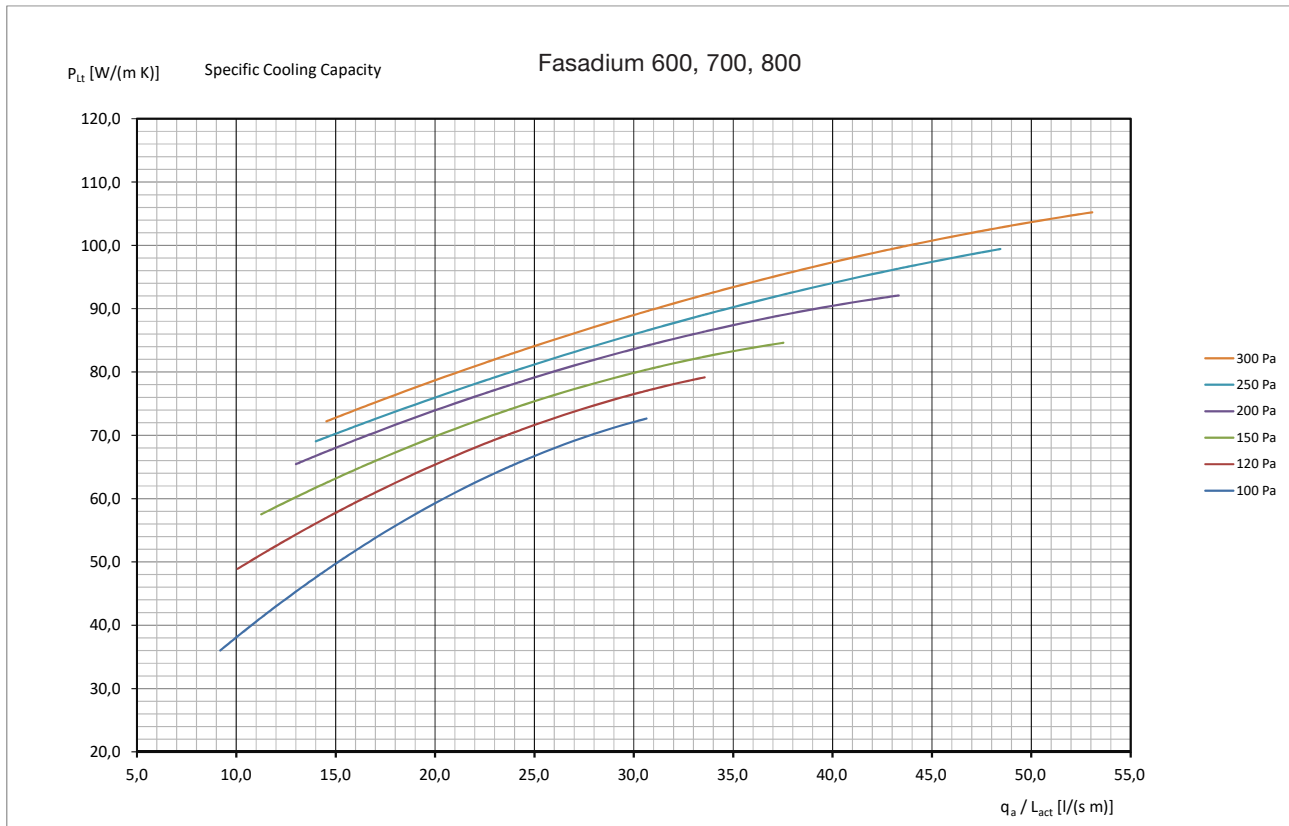

Diagram 2. Fasadium 600, 700, 800: Specific cooling capacity  $P_{Lt}$  as a function of airflow per active metre.

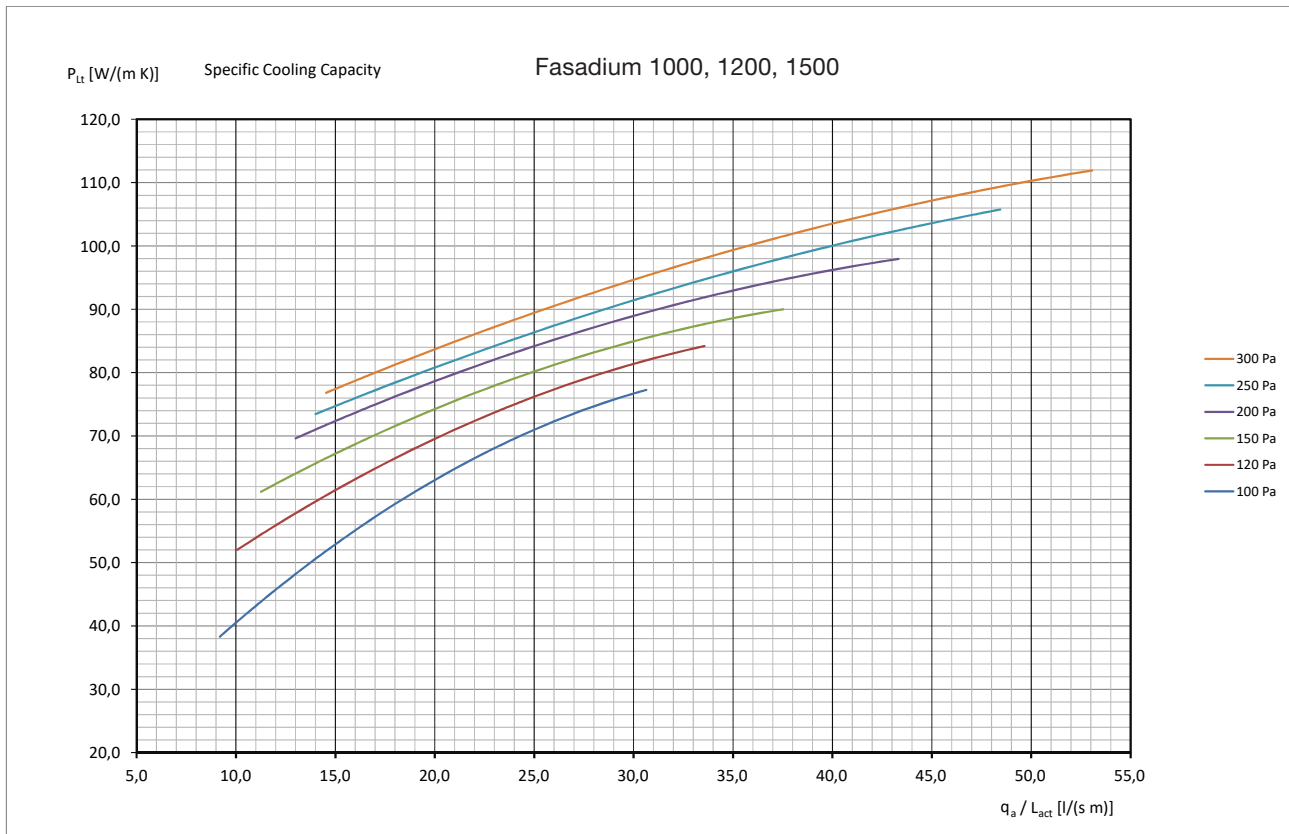

Diagram 3. Fasadium 1000, 1200, 1500: Specific cooling capacity  $P_{Lt}$  as a function of airflow per active metre.

# Facade system

# Fasadium

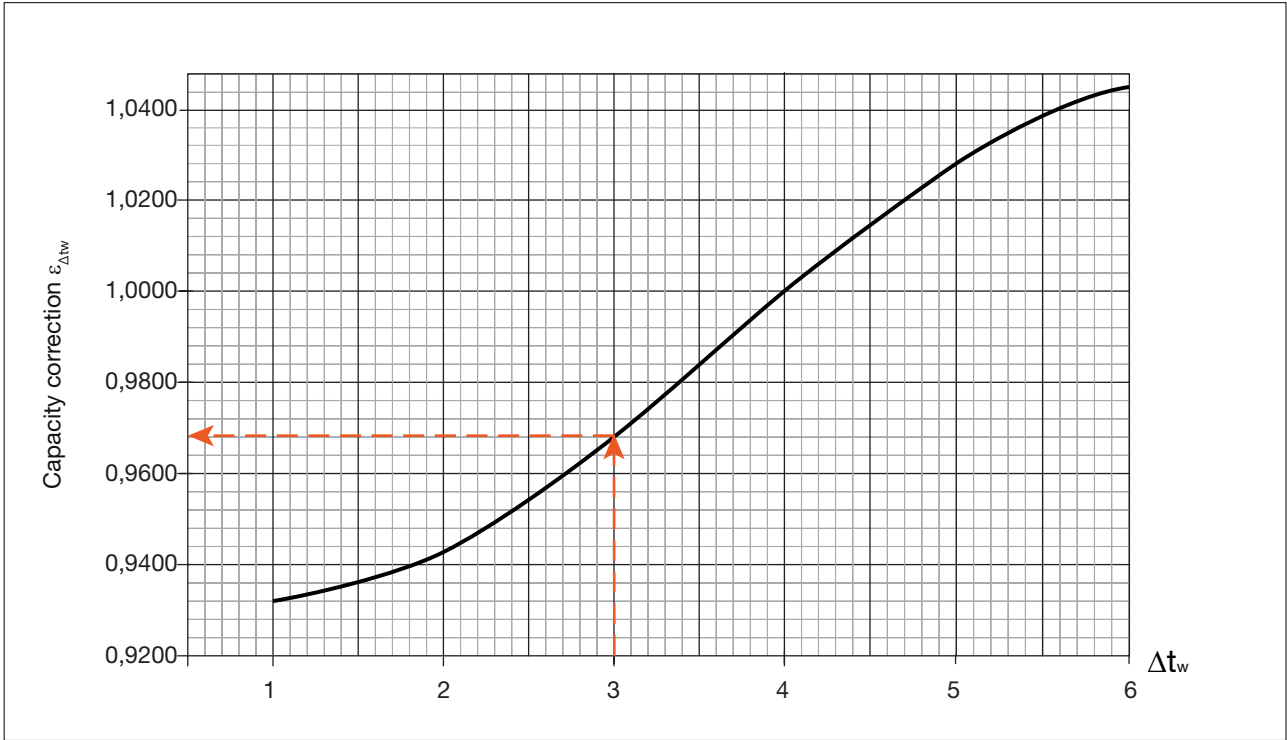

Diagram 4. Capacity correction  $\epsilon_{\Delta t_w}$  as a function of  $\Delta t_w$ . Only applies for cooling.

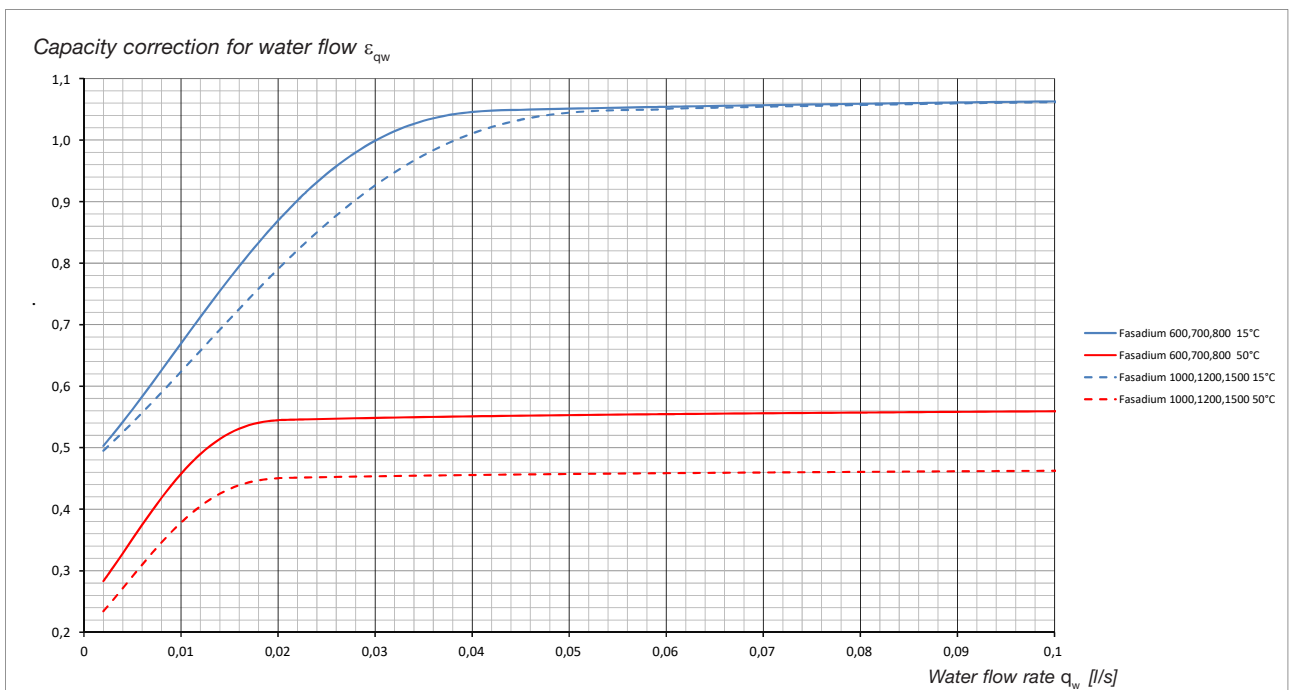

Diagram 5. Capacity correction  $\epsilon_{q_w}$  for water flow for both cooling and heating.

For easy calculation please go to: Lindabs Quick Selection Tool on [www.lindQST.com](http://www.lindQST.com).

# Facade system

# Fasadium

## Minimum airflow at different pressures

System size						
Nozzle Pressure [Pa]	600	700	800	1000	1200	1500
60	6	8	10	13	16	21
80	5	7	8	11	14	18
100	5	6	7	9	12	15
120	4	5	6	8	10	13
150	3	4	5	7	8	11
200	3	4	4	6	7	9
250	3	3	4	5	7	9

Table 2. Minimum airflow [l/s] at different pressures for the air from Fasadium to reach the ceiling with a room height of max. 2.7 m. Temp. difference between room air and mean water temperature  $\Delta t_{rw} = 10$  K (or lower).

## Heating – natural convection

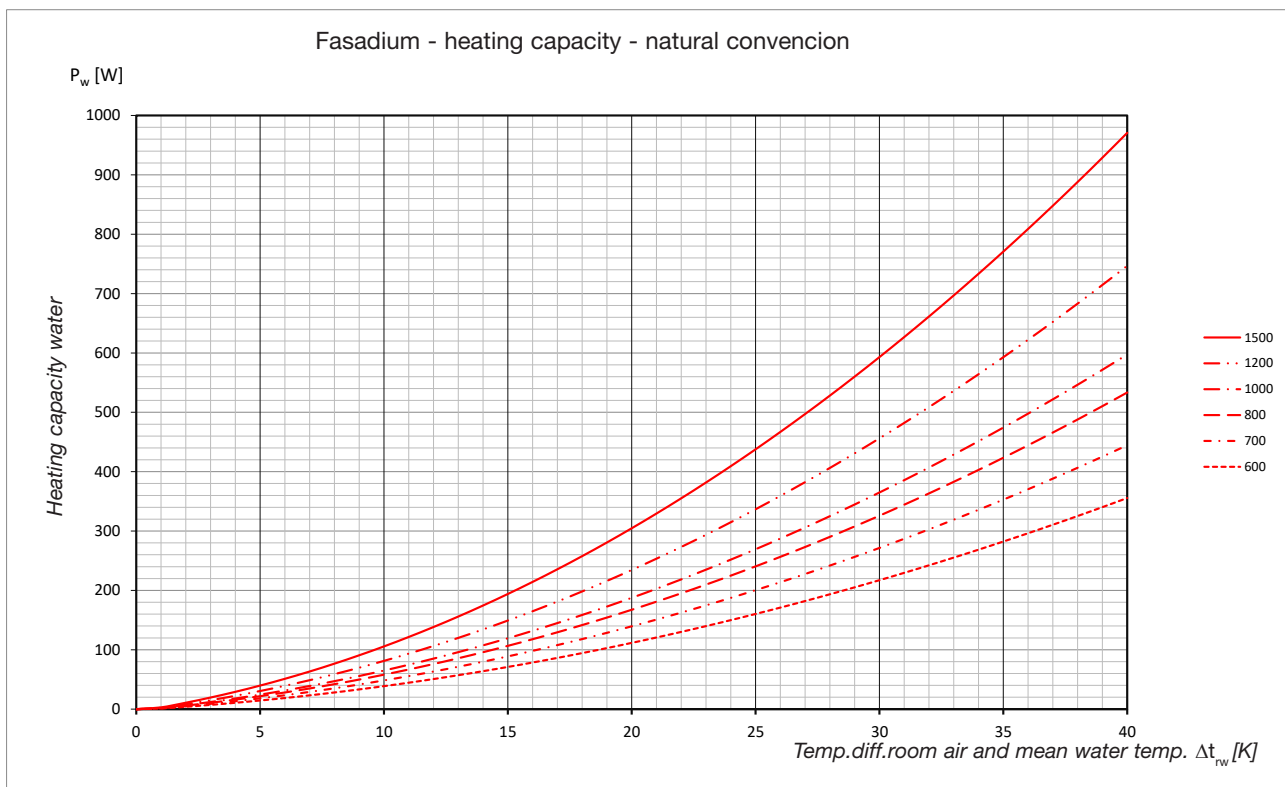

Diagram 6. Fasadium natural convection heating capacity at nominal water flow.

# Facade system

# Fasadium

## Sound power level

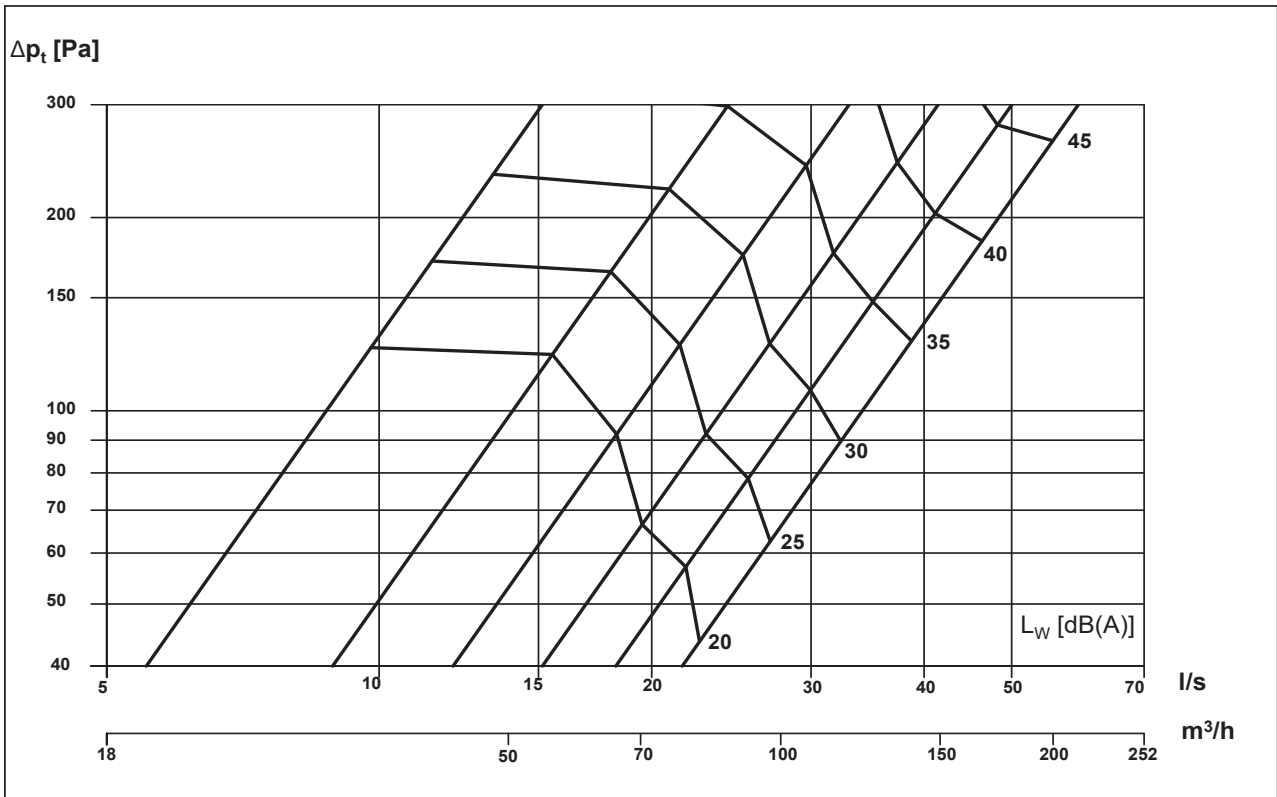

Diagram 7. Sound power level  $L_w$  for  $\text{Ø}100$  connection.

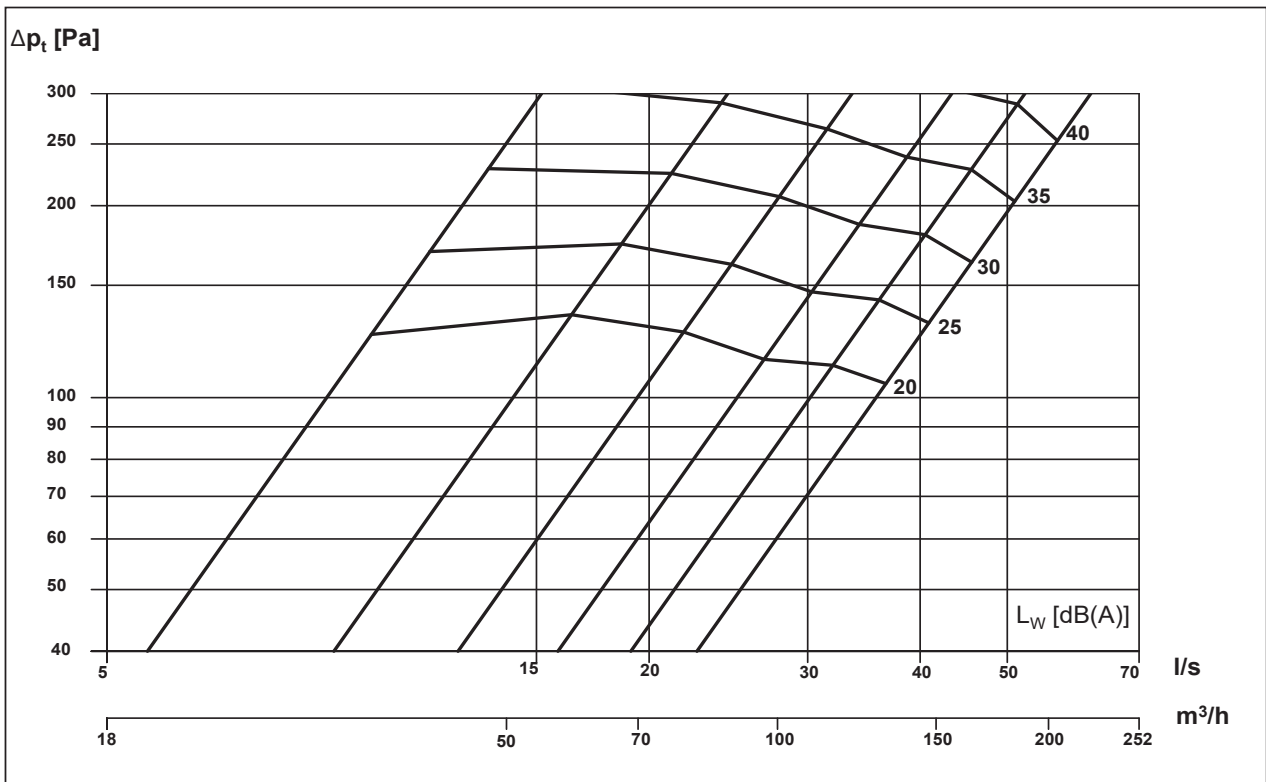

Diagram 8. Sound power level  $L_w$  for  $\text{Ø}160$  connection.

# Facade system

# Fasadium

## Sound power level

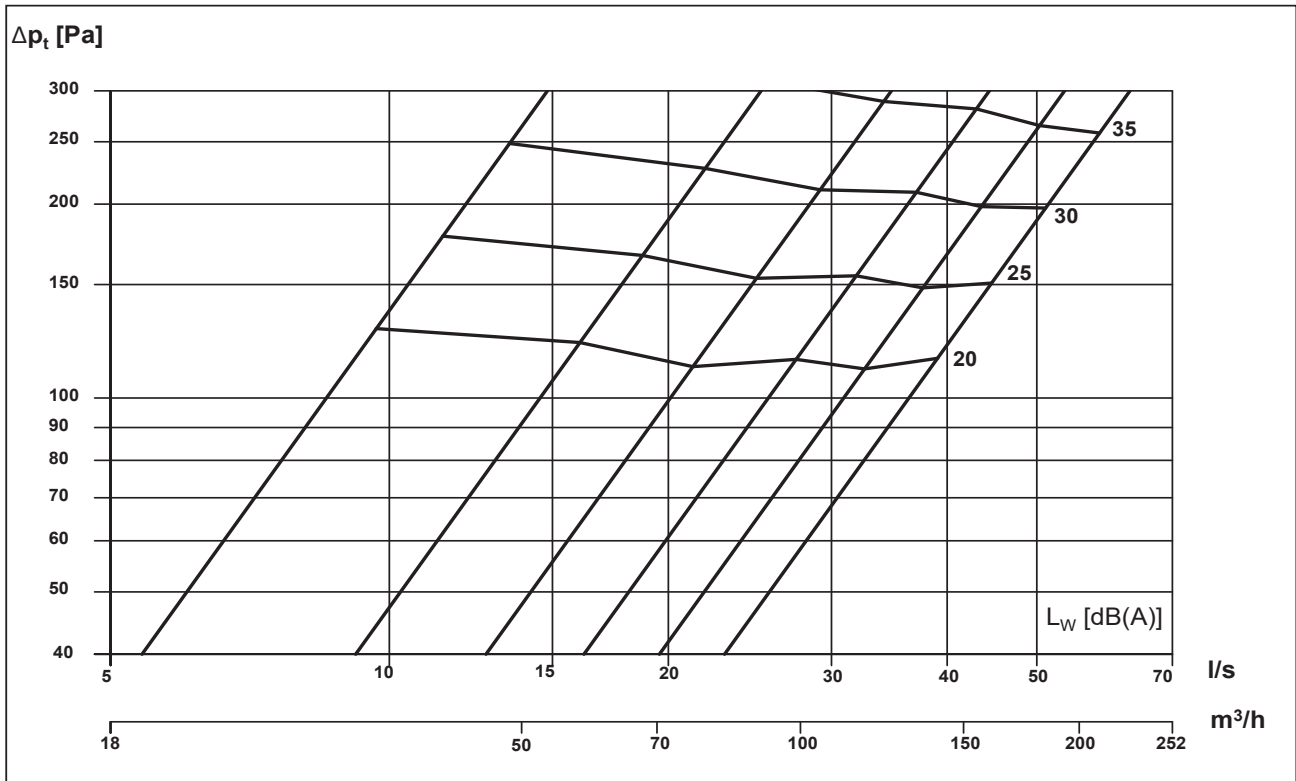

Diagram 9. Sound power level  $L_w$  for Ø200 connection.

# Facade system

# Fasadium

## Sound pressure level

### Example 2:

What is the sound pressure level in the first system of several systems connected in series?

The airflow to the first unit is 100 l/s.  
The duct diameter ( $\varnothing$ ) is 160.

### Answer:

Read off the sound pressure level from diagram 10, Inherent noise generation in the first system. The value is 26 dB(A). Add the value to the system's sound pressure level - 25 dB(A). Read off the increase from diagram 11, Logarithmic addition of two levels, and add it to give a higher sound pressure level.

Diagram 11 shows a value of approx. 2.6 dB(A), which must be added to the higher level, 26 dB(A). Round off to a whole dB(A) value. The result is a total sound pressure level of 29 dB(A).

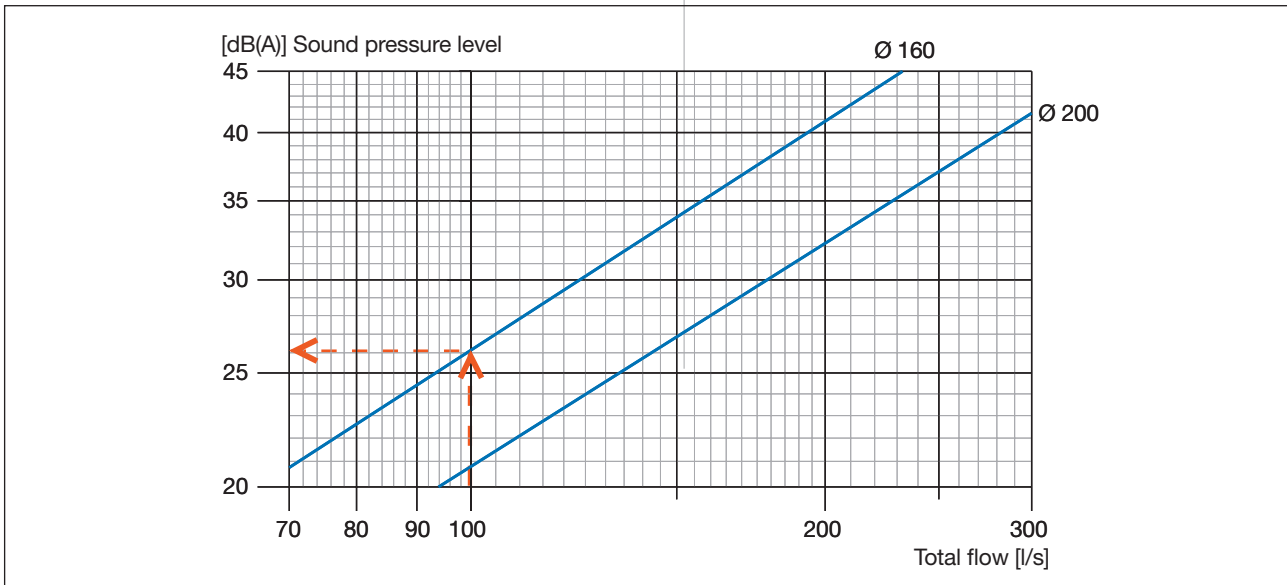

Diagram 10. Inherent noise generation in the first system. Sound pressure level with 10 m<sup>2</sup> Sabine attenuation.

## Sound pressure level

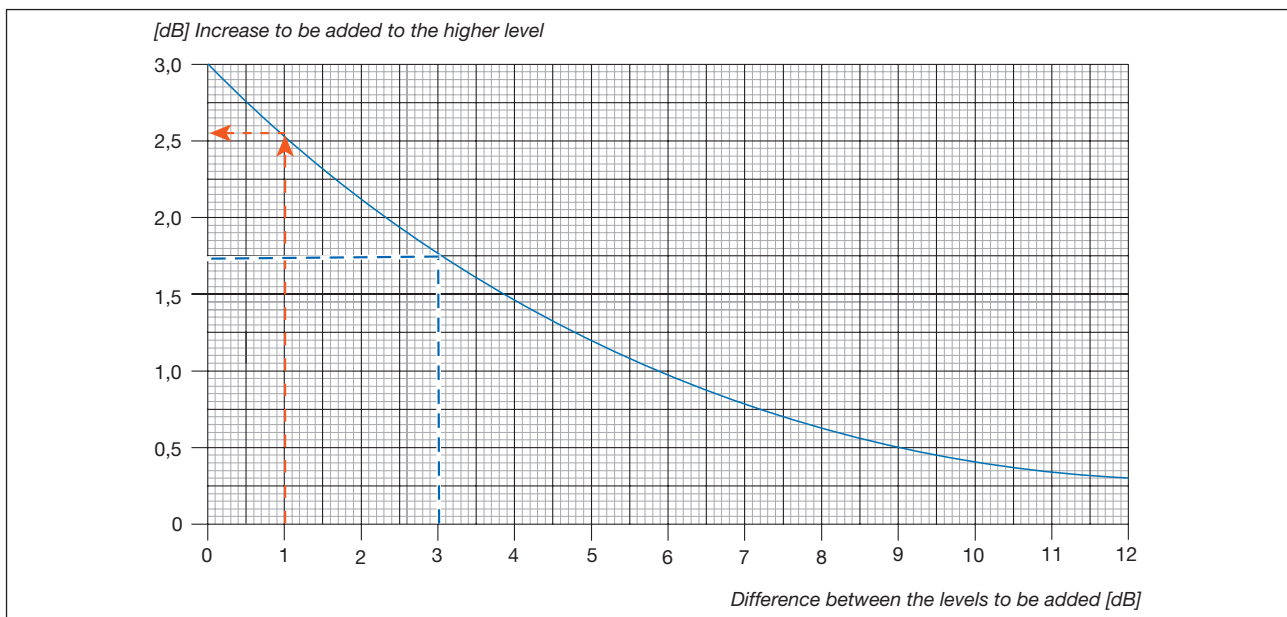

Diagram 11. Logarithmic addition of two levels.



# Facade system

# Fasadium

For easy calculation please go to: Lindabs Quick Selection Tool on [www.lindQST.com](http://www.lindQST.com).

## Internal sound dampening

Size	Frequency (Hz)							
	63	125	250	500	1000	2000	4000	8000
600	19	13	14	12	15	18	13	13
700	18	12	13	11	14	17	12	12
800	17	11	12	10	13	16	11	11
1000	16	10	11	9	12	15	10	10
1200	15	9	10	8	11	14	9	9
1500	14	8	9	7	10	13	8	8

Table 3. Total sound power reduction from connecting duct to the room, including end reflection.

## Weight and water volume

Product	Fasadium 600	Fasadium 700	Fasadium 800	Fasadium 1000	Fasadium 1200	Fasadium 1500
Dry weight, kg Ø100 duct	6.6	7.5	8.5	11.3	13.7	17.0
Dry weight, kg Ø160 duct	7.0	8.0	9.0	12.0	14.5	18.0
Dry weight, kg/m Ø200 duct	7.6	8.5	9.5	12.7	15.3	19.0
Water content, cooling, l/m	0.57	0.17	0.83	1.15	1.42	1.83
Water content, heating, l/m	0.13	0.16	0.18	0.10	0.13	0.16
Copper pipes, quality	EN 12735-2 CU-DHP					
Pressure class	PN10					

Table 4. Weight and water volume.

# Facade system

# Fasadium

## Pressure drop in water circuit, cooling

System length [mm]	600	700	800	1000	1200	1500
Nominal water flow: $q_{wnom}$ [l/s]	0.030	0.030	0.030	0.038	0.038	0.038
Minimum water flow: $q_{wmin}$ [l/s]	0.015	0.015	0.015	0.025	0.025	0.025

Table 5. Fasadium, water flow cooling.

For easy calculation please go to: Lindabs Quick Selection Tool on [www.lindQST.com](http://www.lindQST.com)

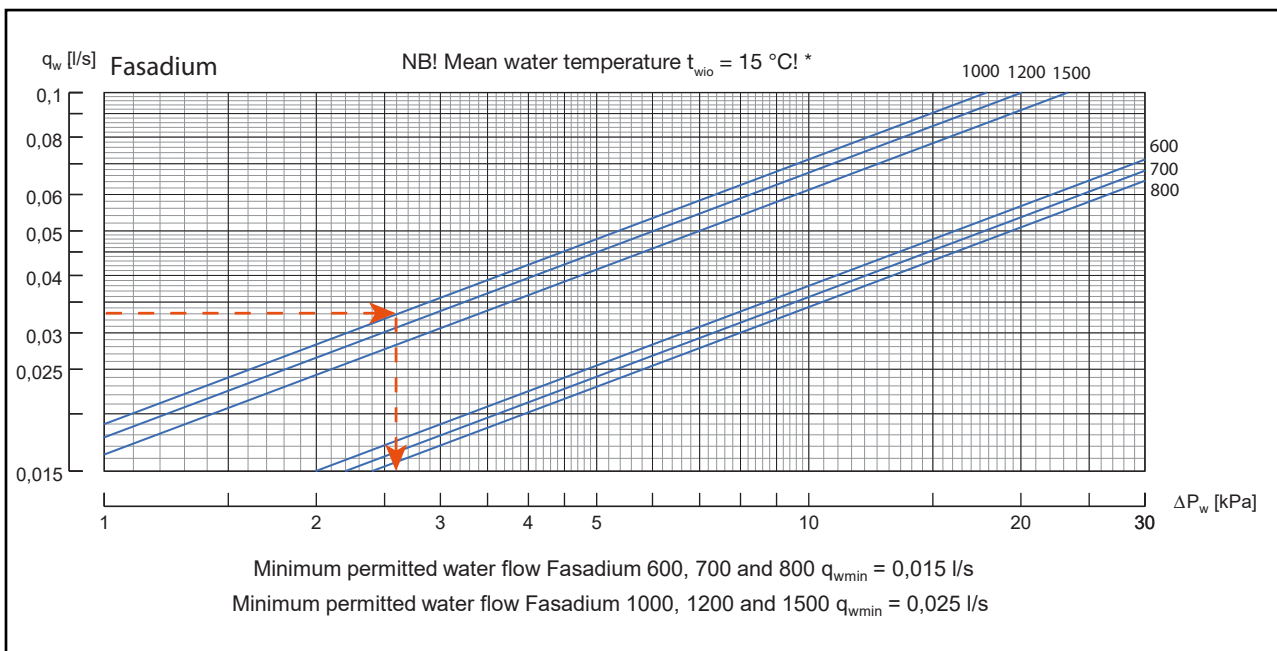

Diagram 12. Pressure drop in the battery's cooling circuit.

### Example 3 Cooling:

Fasadium 1000, which provides an output of 419 W.

$$\Delta t_w = 3 \text{ K}$$

$$q_w = P_w / (c_{pw} \times \Delta t_w)$$

$$q_w = 419 / (4200 \times 3) = 0.033 \text{ l/s}$$

The pressure drop in the water circuit in diagram 12 is read off as  $\Delta p_w = 2.6 \text{ kPa}$ .

### Definitions:

$q_w$  = Water flow rate [l/s]

$P_w$  = Cooling capacity water [W]

$c_{pw}$  = Specific heat capacity water [4200 Ws/(kg K)]

$\Delta t_w$  = Temperature difference water circuit [K]

$t_{wio}$  = Mean water temperature [°C]

$\Delta p_w$  = Pressure loss water circuit [kPa]

\* Diagrams are for a certain mean water temperature  $t_{wio}$ . For other temperatures please do your calculations in our waterborne calculator in [www.lindQST.com](http://www.lindQST.com)!

# Facade system

# Fasadium

## Pressure drop in water circuit, heating

System length [mm]	600	700	800	1000	1200	1500
Norminal water flow: $q_{wnom}$ [l/s]	0.030	0.030	0.030	0.030	0.030	0.030
Minimum water flow: $q_{wmin}$ [l/s]	0.018	0.018	0.018	0.018	0.018	0.018

Table 6. Fasadium, water flow heating.

For easy calculation please go to: Lindabs Quick Selection Tool on [www.lindQST.com](http://www.lindQST.com)

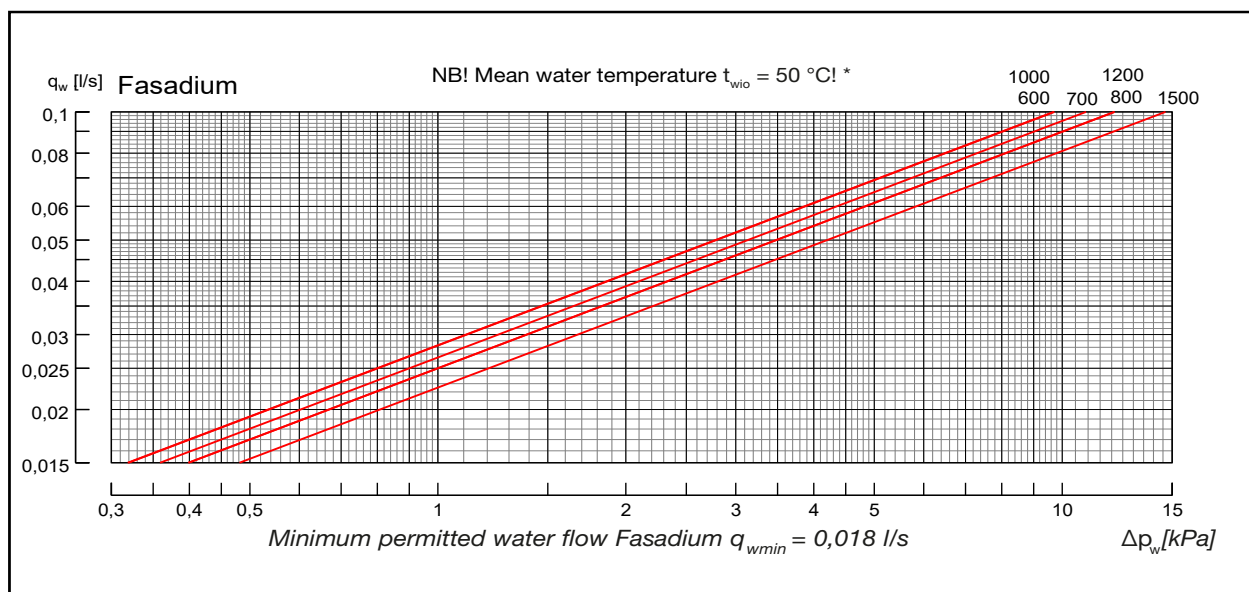
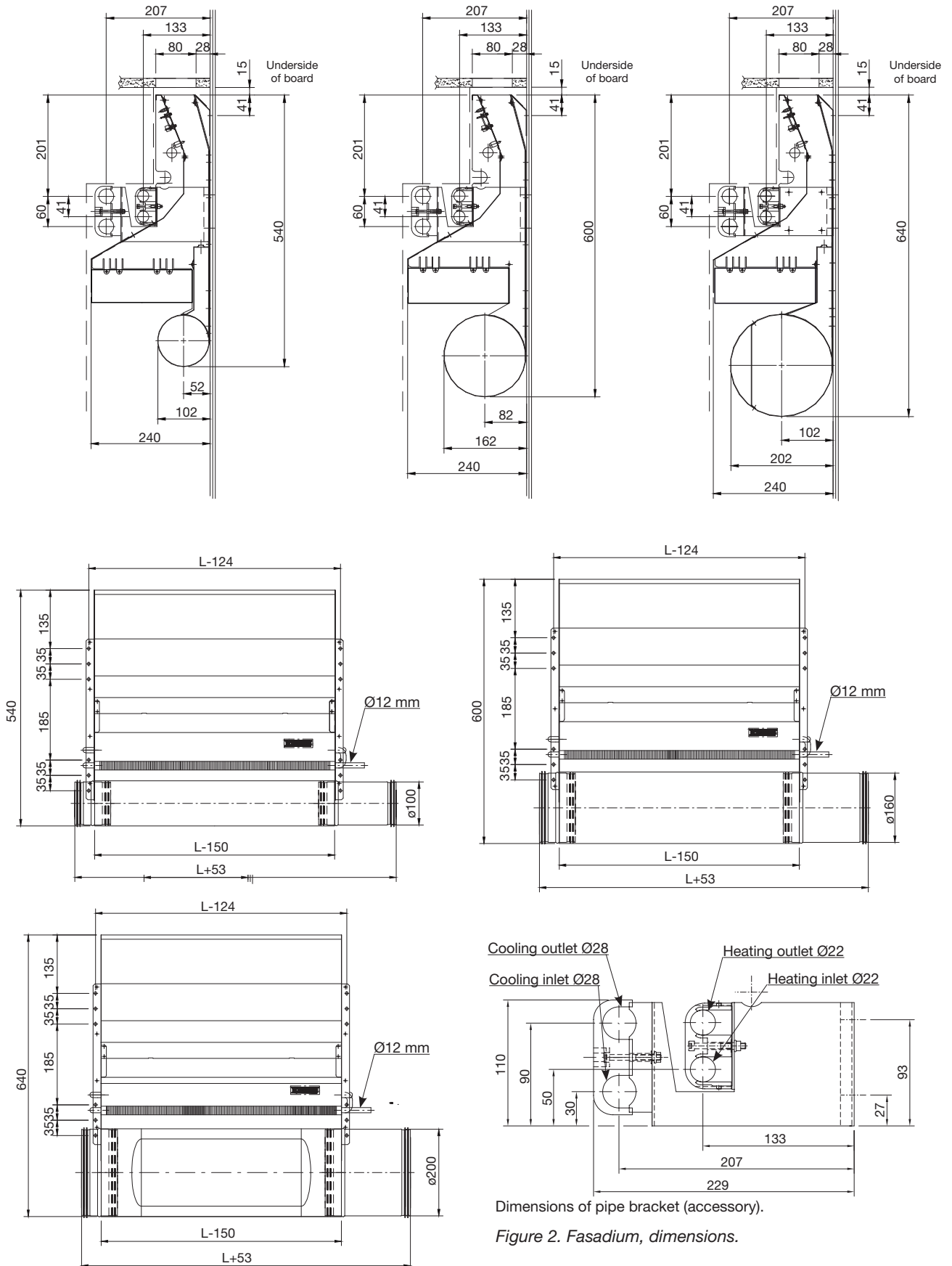

Diagram 13. Pressure drop in the battery's heating circuit.

# Facade system

# Fasadium

## Dimensions



Dimensions of pipe bracket (accessory).

Figure 2. Fasadium, dimensions.

# Facade system

# Fasadium

## Battery types

Figure 3. Shows a battery of Fasadium with unit length of  $\leq 0.8\text{m}$ .

Figure 4. Shows a battery of Fasadium with unit length of  $\geq 1.0\text{m}$

**A = Supply**

**B = Return**

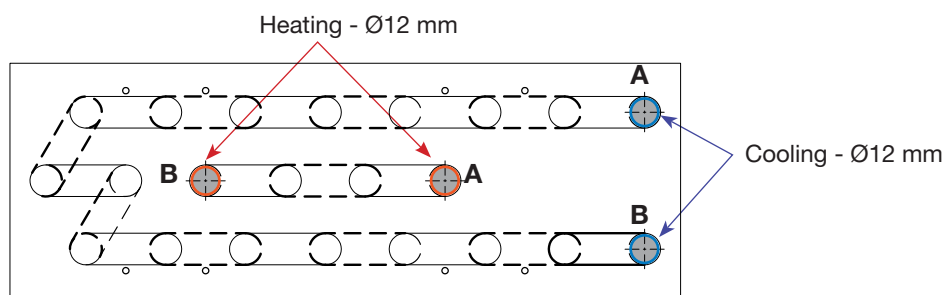

Figure 3. Fasadium: 600, 700, 800

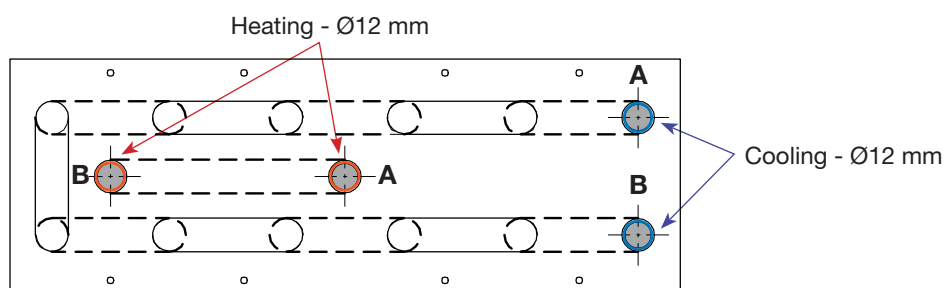

Figure 4 Fasadium: 1000, 1200, 1500

# Facade system

# Fasadium

## Distribution diagrams

### Fasadium - 800

The measurements were conducted with cooled supply air ( $\Delta t$  room air – supply air 6 K) and cooling in the water circuit ( $\Delta t$  room – mean water temperature 10 K). Measurements were made according to the V method. All heat supplied through the walls.

Calculations for other distances between cooling baffles and for the selection of other air volumes are referred to the Indoor Climate Program.

[www.lindQST.com/waterborne/calculator/default.aspx](http://www.lindQST.com/waterborne/calculator/default.aspx)

Isolevels 0.20 m/s

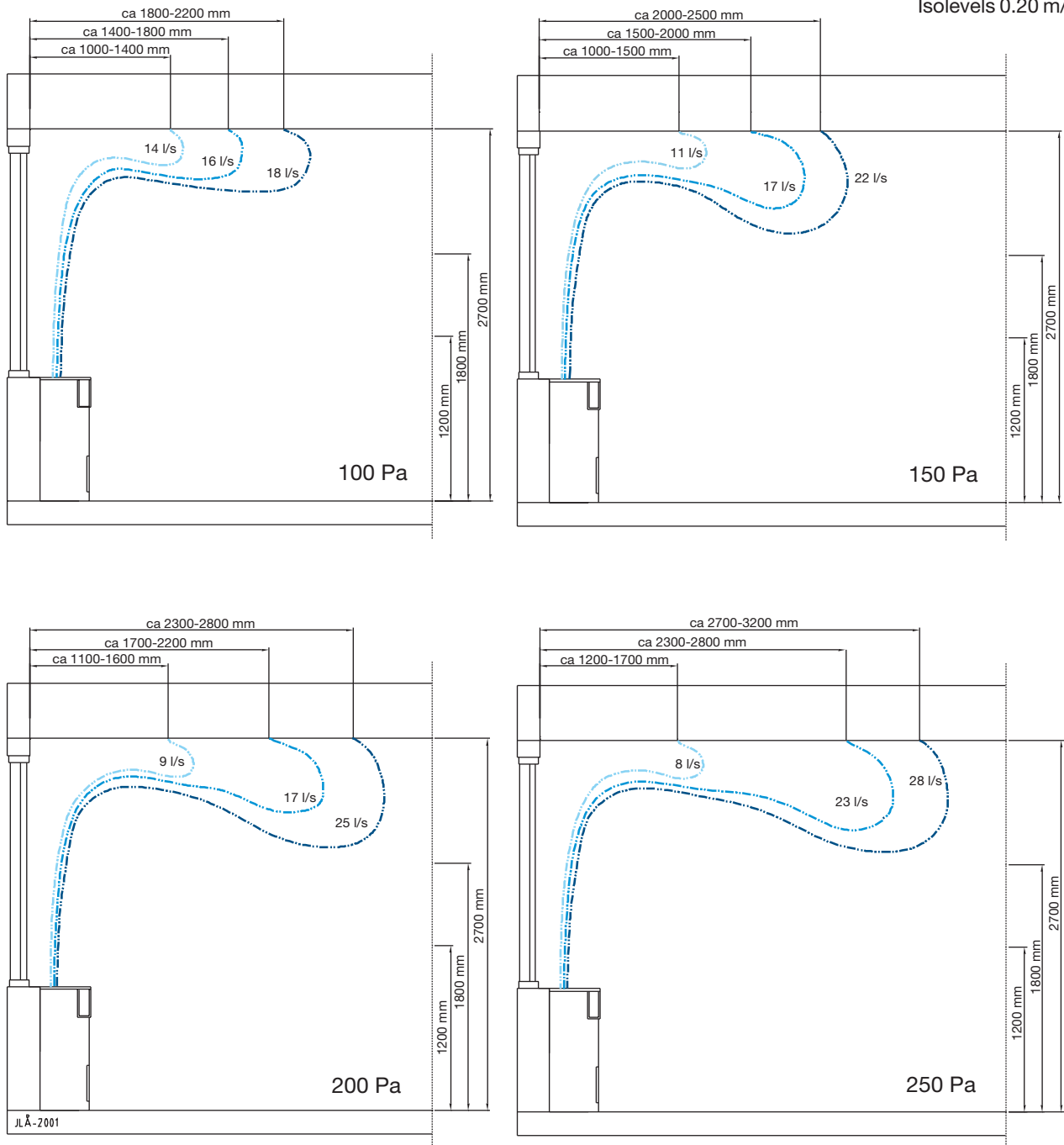

Figure 5. Fasadium – 800 distribution diagrams, different air and flow settings.

# Facade system

# Fasadium

## Distribution diagrams

### Fasadium 1200

The measurements were conducted with cooled supply air ( $\Delta t$  room air – supply air 6 K) and cooling in the water circuit ( $\Delta t$  room – mean water temperature 10 K). All heat supplied through the walls.

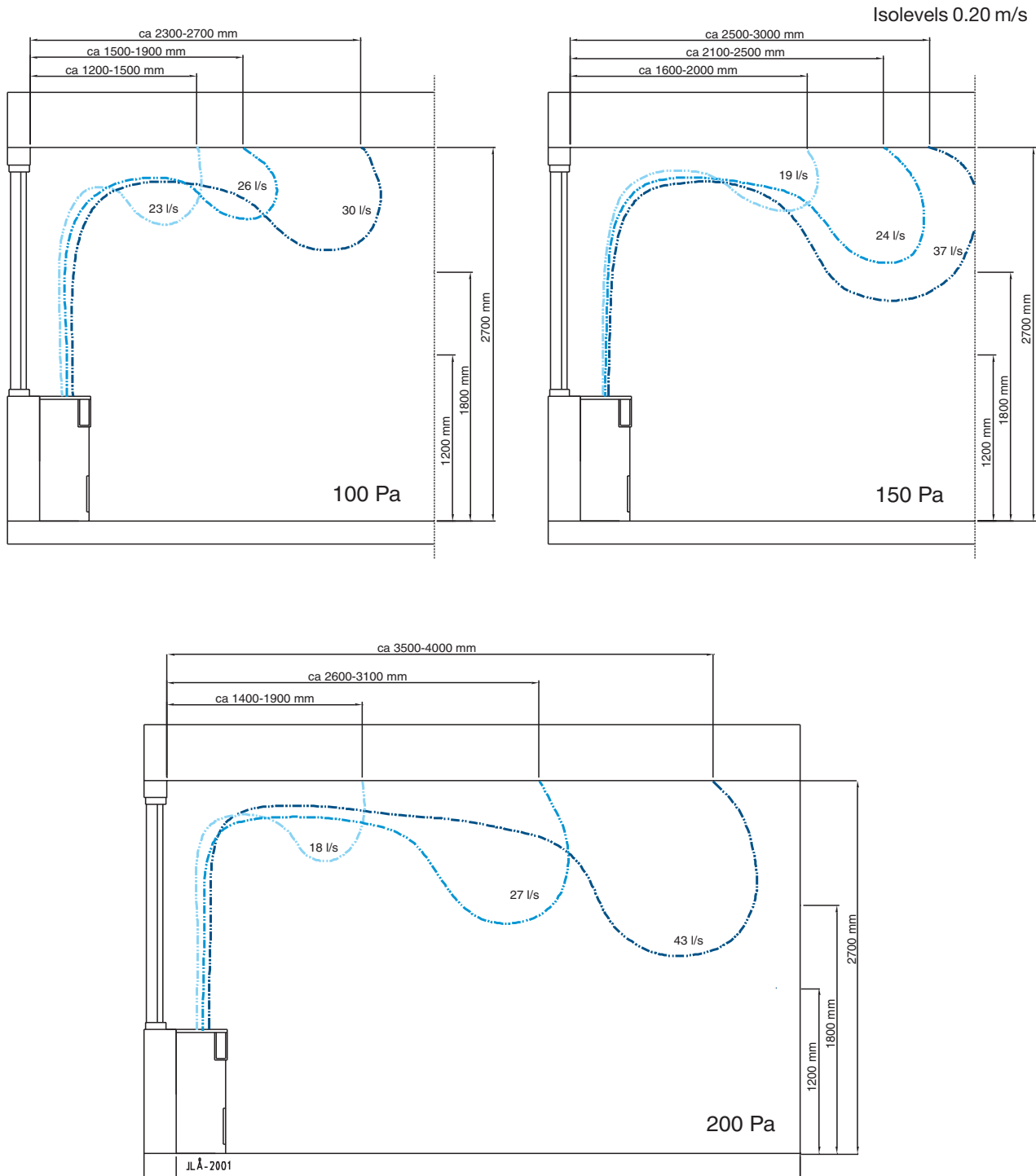

Figure 6. Fasadium – 1200 distribution diagrams, different air and flow settings.

# Facade system

# Fasadium

## LindQST - just a click away

The Lindab Quick Selection Tool, [LindQST®](#), is a very fast, easy-to-use and flexible online tool for your daily work.

[Calculate the Fasadium here](#)



Picture 11. LindQST - Indoor Climate Designer

LindQST® helps you select the right waterborne products, e. g. active chilled beams, passive radiant chilled beams, radiant cooling- and heating panels and facade units and quickly finds the corresponding documentation.

In *Waterborne Documentation* you can easily find all available product documentation. Always in the latest version.

In *Waterborne Calculator* you can do a professional calculation based on your specific input data to finetune your choice or calculate different variants of the product. Smart warnings point out if a set-up will not work.

In *Waterborne Selector* you can compare the proposed products according to your specific requirements and select the one which fits best to your needs .

Not enough? With *Indoor Climate Designer* you can insert your selected waterborne product into your room and simulate the actual air distribution, optimize the placing in the ceiling taking into account the calculated air velocities and sound levels.

You can at anytime display your selection and calculations graphically. In addition, you can print or save all results and related documents for your documentation (incl. data sheets, dxf-files and room books).

With LindQST® you will easily find the most suitable product for your project.

It provides an easy and quick access to the latest product information, technical specifications and assembly instructions on the Internet, making it the ideal tool installers, consultants and architects alike.

[www.LindQST.com](http://www.LindQST.com)

- Fast product selection waterborne products in accordance to Eurovent (chilled beams and facade units).
- Easy access to all current documentation.
- Fast design of waterborne products.
- Indoor Climate Designer: Graphical representation of the spatial situation in 2D / 3D and floor plans from AutoCAD®.
- Calculation of capacities, sound power levels, pressure losses and flow conditions.
- 3D particles or smoke show the air distribution in the room.
- Diagram showing the time course of the CO<sub>2</sub> concentration in the room.
- Room book generation and data sheet for individual rooms and outlets or entire projects.
- Project can be saved and exchanged in its own project area.





# Facade system

# Fasadium

## Control

Lindab offers control equipment that is very simple to use.

To avoid the heating and cooling being activated at the same time, the system is controlled sequentially (Regula Combi). For the technical data, refer to the chapter Regula.



## Designations

<b>System:</b>	Fasadium
<b>Length, [mm]:</b>	600, 700, 800, 1000, 1200, 1500
<b>Duct dimension, [mm]:</b>	Ø100, Ø160, Ø200
<b>Height, [mm]:</b>	540-Ø100, 600-Ø160, 640-Ø200
<b>Air quantity, [l/s]:</b>	8 - 69 l/s
<b>Nozzle pressure, [Pa]:</b>	60 - 300 Pa
<b>Plus features:</b>	see page 8

## Order code

Product	Fasadium	24	1000	600	160	150	20
Type:							
24							
Product length:							
600, 700, 800, 1000, 1200, 1500							
Height:							
540-600-640							
Air connection:							
100, 160, 200							
Static nozzle pressure (Pa):							
60-300							
Air volume (l/s):							
8-69							

## Programme text

Fasadium is a facade system with heating, cooling and ventilation functions. Fasadium uses the supply air's driving power, which through induction creates a flow of air through the battery, thereby ejecting cooled or heated air from the system.

Fasadium is developed for an operating pressure of up to 300 Pa. Fasadium utilises counter-flow heat exchange.

The system is provided with a service hatch, which provides full access to the whole battery and helps maintain good hygiene.

### Facade systems from Lindab

### Qty

#### Product:

Fasadium -24-1000-600-160

40

Air quantity:

20 l/s

Air pressure:

150 Pa

#### Plus features:

Regula Secura condensation guard:

#### Accessories:

Regula Combi:

40

Thermostat cable:

40

Extension cables:

40

Pipe bracket:

80

Termination pack, incl. air bleed:

10

Galea grill 1000 RAL 9003:

40



Most of us spend the majority of our time indoors. Indoor climate is crucial to how we feel, how productive we are and if we stay healthy.

We at Lindab have therefore made it our most important objective to contribute to an indoor climate that improves people's lives. We do this by developing energy-efficient ventilation solutions and durable building products. We also aim to contribute to a better climate for our planet by working in a way that is sustainable for both people and the environment.

[Lindab](#) | For a better climate