

Lindab **GS23**

Versio - Ceiling diffusers



Versio - Ceiling diffusers

GS23



GS23 with grille box type V.

Description

GS23 is a square diffuser with an aluminium grid. GS23 is used for extract. Installing a GS23-V diffuser in a plenum box type MB can help to achieve a stable flow of air to the diffuser as well as achieving the option for individual adjustment of air flow.

Damper type B-E is an unique linear cone damper which allows to use the full operational area (0-100%) and allows to balance with a high pressure drop over the box with low sound generation.

Damper type E has a rotating blade damper for extract air. Used for applications that don't require a high balancing pressure in the plenum box.

- High capacity.
- Can be installed with a plenum box with several damper options.

Maintenance

The face plate can be removed to enable cleaning of internal parts or to gain access to the duct or box. The visible parts of the diffuser can be wiped with a damp cloth.

Order code

Product	GS	23	b	E	d	eee	f
Type	GS						
Design	23						
Box type	V - H - R						
Functional use	E = Extract						
Damper	0 = No damper (Box : H, V) 1 = Damper (Box : H, R) 2 = Damper / Meas.outlets (Box : H)						
Connection dim.	Ø160-315 (Box : V) Ø125-500 (Box : H) 200x100 - 500x100 (Box : R)						
Ceiling system	1 - 14	Ceiling systems, see ceiling tile adaption					

Example: GS-23-V-E-0-200-1



GS23 with plenum box type H.

Dimensions

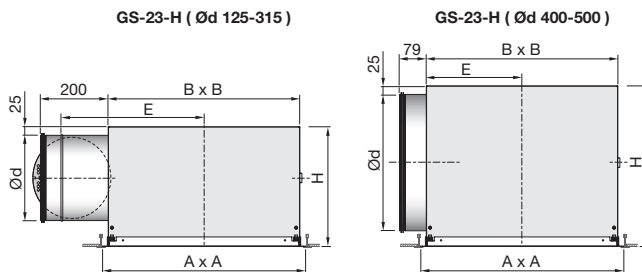

GS23-H

Ød mm	Pattern	A	B	H	E	m kg
125	300	**595	382	226	350	5.9
160	400	**595	382	261	350	5.9
200	500	**595	462	301	390	8.5
250	600	**595	562	351	420	12.3
315	600	**595	562	416	420	13.1

Ød mm	Pattern	A	B	H	E	m kg
400*	600	**595	562	471	281	10.1
500*	600	**595	562	571	281	11.0

* GS23-H Ød = 400 / 500 => 0 = No damper.

** Face plate dimensions A x A shown in tables above are valid for ceiling type 1, T24/T15. The A x A dimension depends on ceiling system. See [Ceiling tile adaption](#) for detailed dimensions. For further details on plenum boxes, see the following pages and configure your GS23 in the LindQST [airborne calculator](#).

Materials and finish

Grille box/plenum box:

Material: Galvanised steel

Face plate:

Material: Galvanised steel

Grid: Aluminium

Standard finish: Powder-coated

Standard colours: RAL 9003 or RAL 9010, gloss 30.

The diffuser is available in other colours. Please contact Lindab's sales department for further information.

Versio - Ceiling diffusers

GS23

GS23-V + MB plenum box

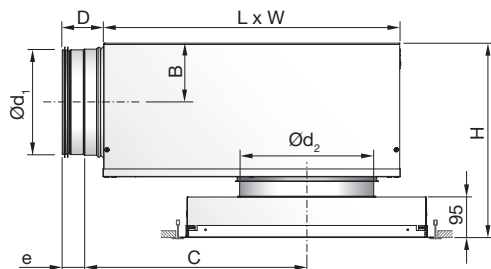

Ød ₁ mm	Ød ₂ mm	Pattern	B	C	D	e	H*	L	W
			mm						
100	160	300	62	245	78	40	247 - 287	310	260
125	160	300	75	291	78	40	272 - 312	376	310
125	200	400	75	291	78	40	272 - 312	376	310
160	160	300	92	352	78	40	306 - 346	459	380
160	200	400	92	352	78	40	306 - 346	459	380
160	250	500	92	352	78	40	306 - 346	459	380
200	200	400	112	425	78	40	347 - 387	565	460
200	250	500	112	425	78	40	347 - 387	565	460
200	315	600	112	425	78	40	347 - 387	565	460
250	250	500	137	514	118	60	397 - 437	698	540
250	315	600	137	514	118	60	397 - 437	698	540
315	315	600	170	675	118	60	462 - 502	858	540

* Using accessory MBZ the H dimension will increase:
 Ød₂ = 100 - 200 mm => H +40 mm
 Ød₂ = 250 - 315 mm => H +60 mm

Damper options



Order code

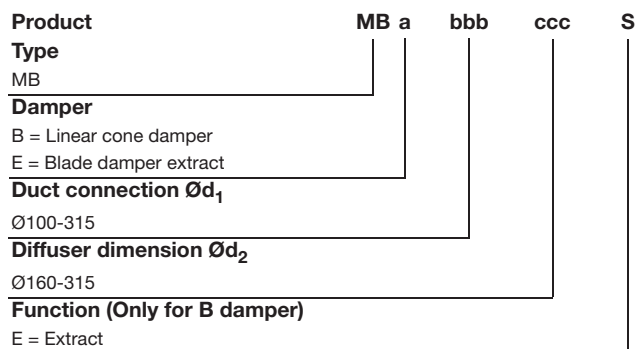

Example 1: GS-23-V-E-0-200-1+MBB-160-200-E
 Example 2: GS-23-V-E-0-200-1+MBE-160-200

GS23 + R plenum box

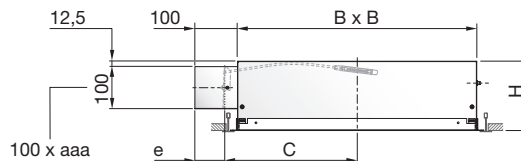

GS23 + R

aaa x 100 mm	Pattern	B	C	H	e
		mm			
200 x 100	400	382	221	161	70
300 x 100	400	382	221	161	70
400 x 100	500	462	261	161	70
500 x 100	600	562	311	161	70

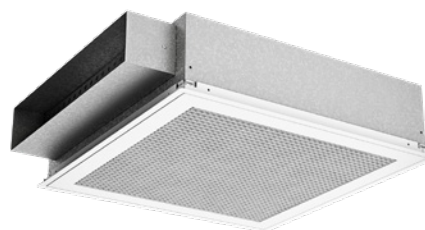

Accessories

MBZ - Extension piece



Order code



Example: MBZ-200

PBB - Mounting bracket (set)



MHS - Suspension



Order code



Example: MHS

Versio - Ceiling diffusers

GS23

Technical data

Following GS23-V+plenum box data are valid for MBB-E . For MBB-E and MBE data, go to the LindQST [airborne calculator](#).

Capacity

Air flow q_v [l/s] and [m³/h], total pressure Δp_t [Pa], throw $l_{0,2}$ [m] and sound power level L_{WA} [dB(A)] can be seen in the diagrams.

Frequency-related sound power level

The sound power level in the frequency band is defined as $L_{WA} + K_{ok}$. K_{ok} values are specified in charts beneath the diagrams on the following pages.

Quick selection - Extract air

GS23-H-2

GS23-H Size Ød mm	Centre frequency Hz							
	63	125	250	500	1K	2K	4K	8K
125	17	16	5	9	10	4	5	5
160	16	14	3	11	11	4	4	4
200	15	9	2	11	7	4	4	6
250	14	8	3	9	4	3	4	6
315	12	6	4	10	3	3	4	6

GS23-H-0

GS23-H Size Ød mm	Centre frequency Hz							
	63	125	250	500	1K	2K	4K	8K
160	17	11	5	6	9	4	3	3
200	18	6	3	6	7	3	4	4
250	14	6	4	11	5	4	3	3
315	10	6	6	10	4	2	4	4
400	10	4	6	6	4	3	3	3
500	9	4	5	5	3	2	3	3

Installation -and balancing instruction

For further information go to [LindQST](#) and get all related documentation, including installation -and balancing instructions.

Sound attenuation

Sound attenuation of the diffusers ΔL from duct to room, including end reflection - see table below.

GS23-V + MBB-E

GS23-V + MBB-E		Centre frequency Hz							
Duct Ød ₁	GS23-V Ød ₂	63	125	250	500	1K	2K	4K	8K
100	160	20	16	5	19	20	19	18	21
125	160	16	13	9	20	18	18	19	20
125	200	14	12	6	17	16	16	18	19
160	160	17	16	10	24	20	20	21	21
160	200	15	15	7	22	21	19	20	21
160	250	15	14	5	20	16	16	17	19
200	200	14	11	7	18	21	17	20	18
200	250	13	9	5	17	18	16	18	17
200	315	13	8	3	15	17	15	17	16
250	250	15	8	7	18	18	18	18	19
250	315	15	7	6	16	16	17	17	18
315	315	8	11	8	16	18	17	17	22

GS23-V without plenum box-Extract air

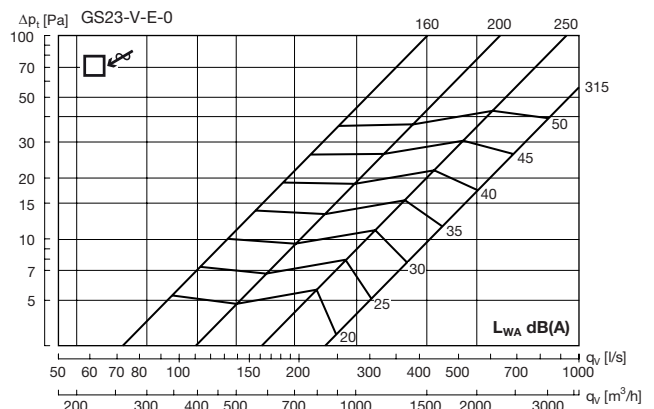

GS23-H without damper - Extract air

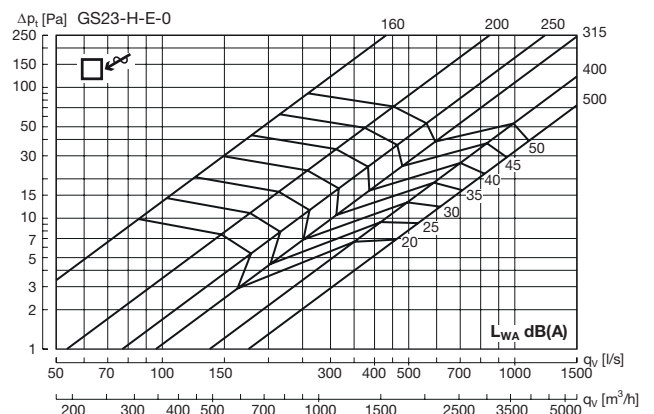

Versio - Ceiling diffusers

GS23

Technical data

GS23-V 160 + MBB-E - Extract air

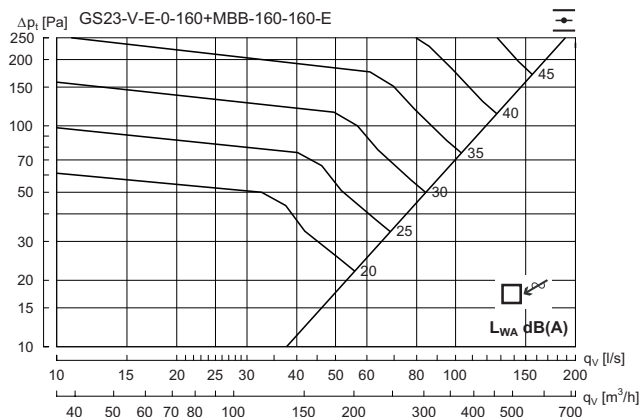

Hz	63	125	250	500	1K	2K	4K	8K
K_{ok}	15	5	0	-3	-6	-9	-14	-19

GS23-V 200 + MBB-E - Extract air

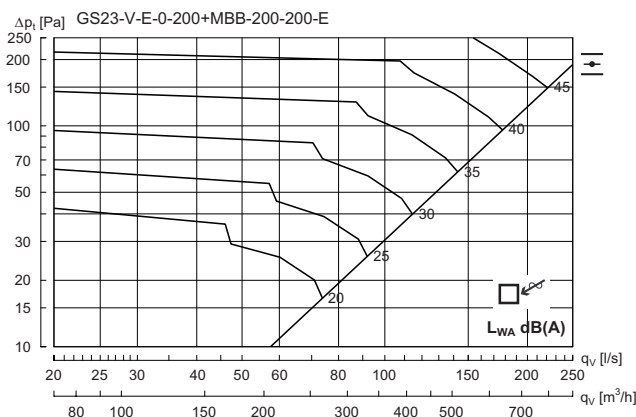

Hz	63	125	250	500	1K	2K	4K	8K
K_{ok}	14	5	1	-3	-6	-9	-13	-21

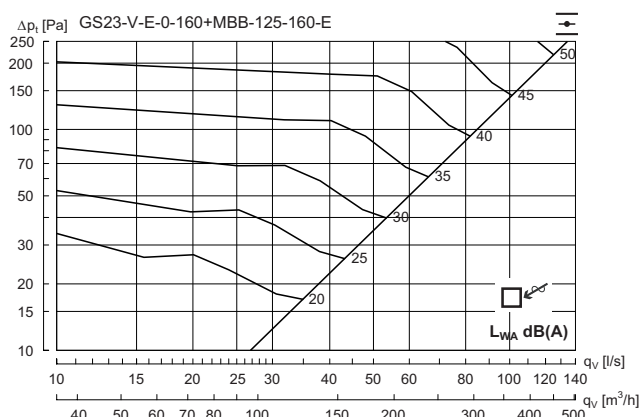

Hz	63	125	250	500	1K	2K	4K	8K
K_{ok}	11	5	1	-2	-6	-11	-15	-22

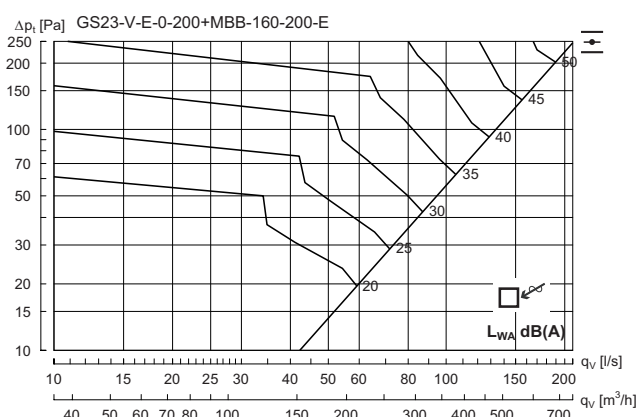

Hz	63	125	250	500	1K	2K	4K	8K
K_{ok}	14	5	0	-3	-6	-9	-14	-21

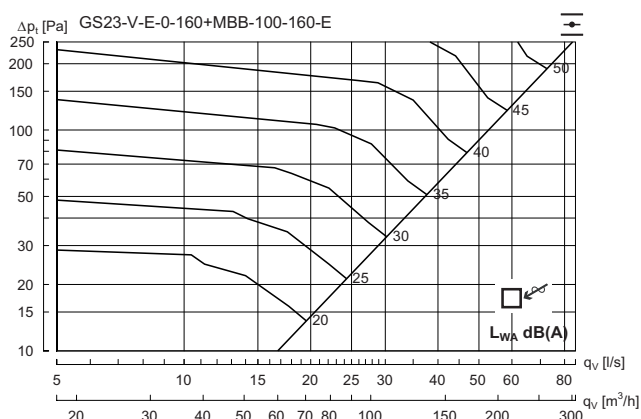

Hz	63	125	250	500	1K	2K	4K	8K
K_{ok}	8	4	4	-2	-8	-12	-16	-23

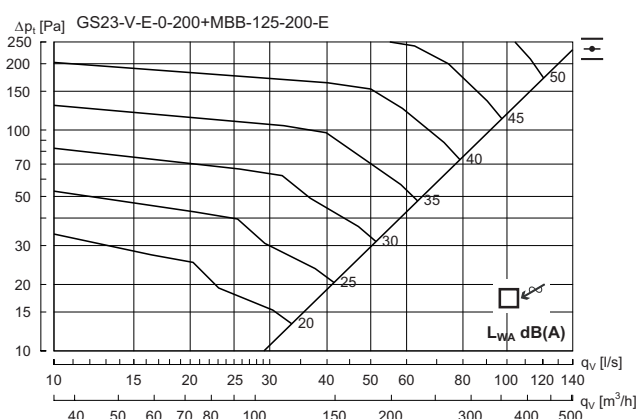

Hz	63	125	250	500	1K	2K	4K	8K
K_{ok}	9	4	1	-1	-6	-11	-15	-22

Versio - Ceiling diffusers

GS23

Technical data

GS23-V 250 + MBB-E - Extract air

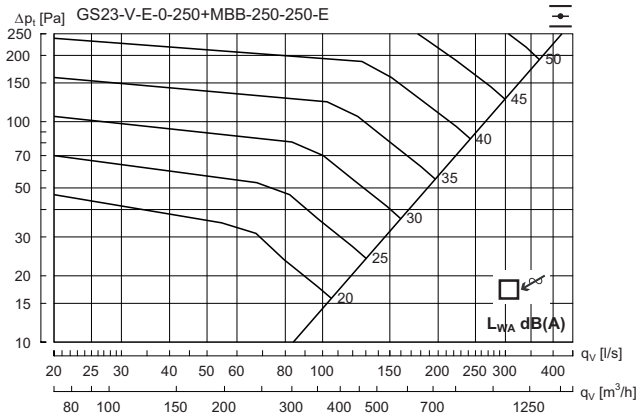

Hz	63	125	250	500	1K	2K	4K	8K
K_{ok}	10	5	2	-3	-6	-9	-15	-23

GS23-V 315 + MBB-E - Extract air

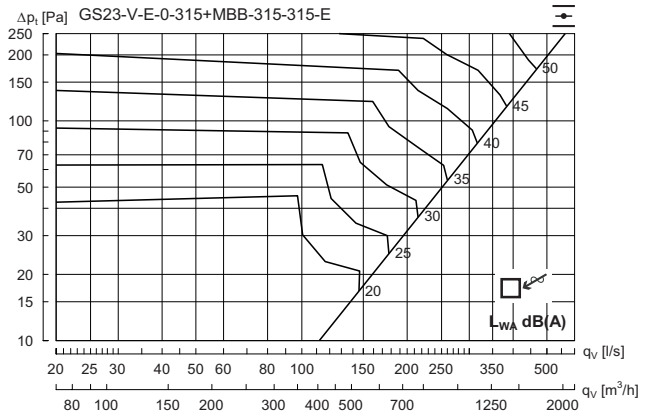

Hz	63	125	250	500	1K	2K	4K	8K
K_{ok}	11	5	3	-4	-7	-9	-14	-25

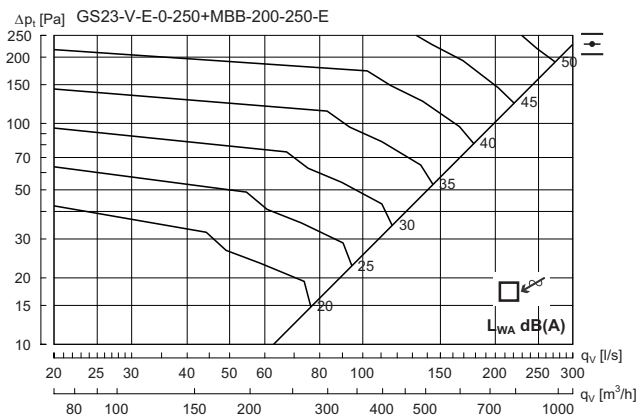

Hz	63	125	250	500	1K	2K	4K	8K
K_{ok}	13	5	1	-3	-6	-10	-14	-22

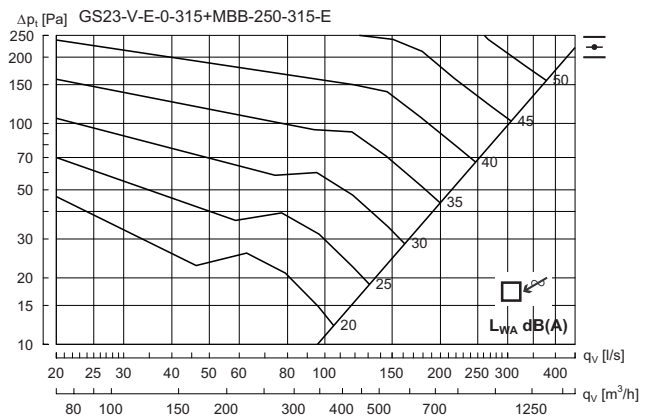

Hz	63	125	250	500	1K	2K	4K	8K
K_{ok}	11	5	2	-3	-6	-10	-15	-24

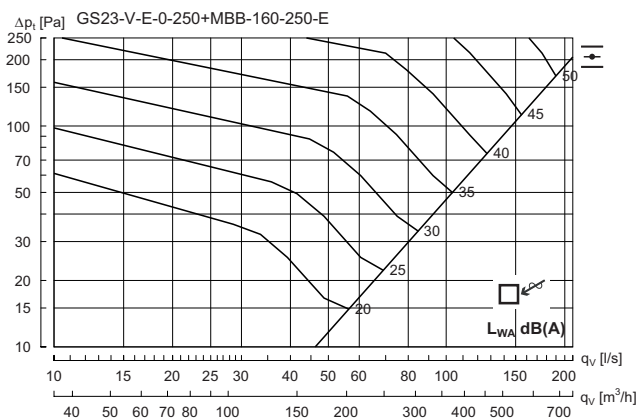

Hz	63	125	250	500	1K	2K	4K	8K
K_{ok}	13	5	1	-3	-6	-9	-14	-22

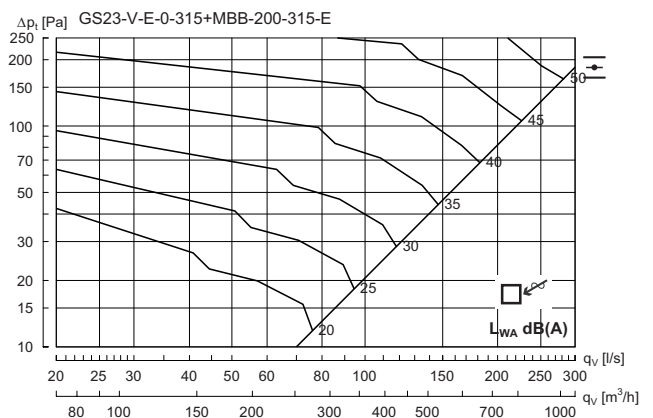

Hz	63	125	250	500	1K	2K	4K	8K
K_{ok}	13	5	1	-3	-6	-9	-14	-22

Versio - Ceiling diffusers

GS23

Technical data

Extract with plenum box type H

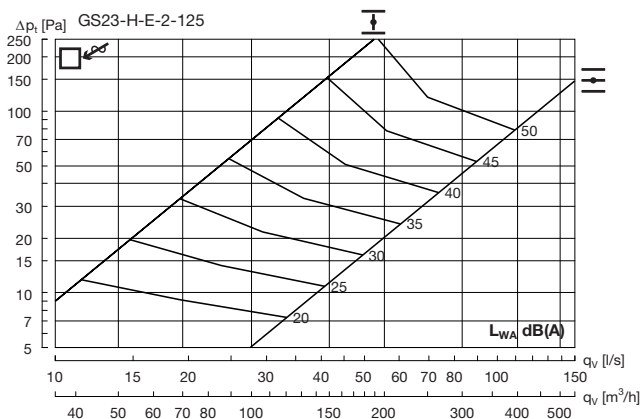

Hz	63	125	250	500	1K	2K	4K	8K
K_{ok}	4	4	5	-3	-9	-11	-18	-25

Extract with plenum box type H

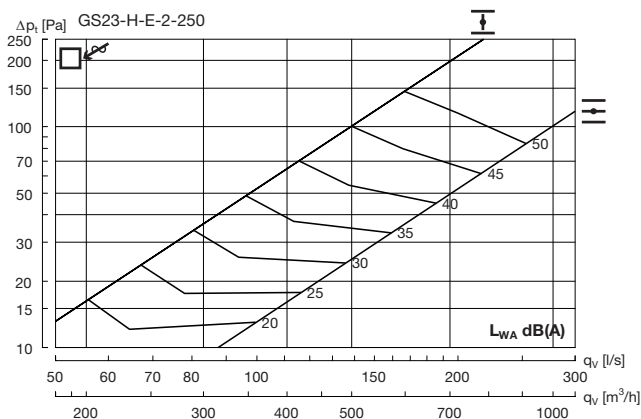

Hz	63	125	250	500	1K	2K	4K	8K
K_{ok}	3	6	2	-2	-6	-12	-21	-32

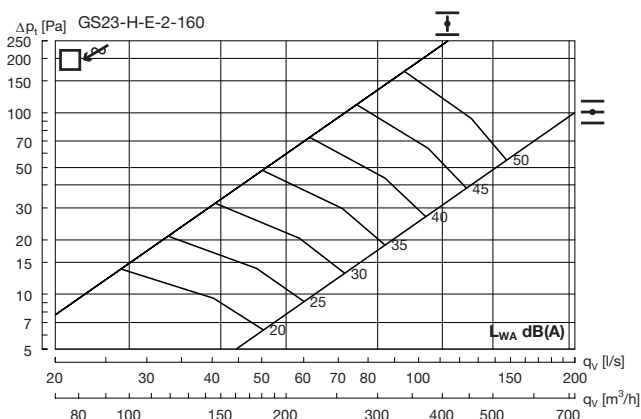

Hz	63	125	250	500	1K	2K	4K	8K
K_{ok}	6	4	6	-3	-10	-13	-20	-29

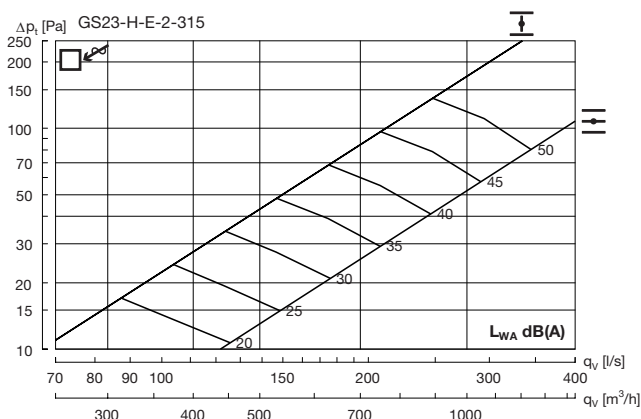

Hz	63	125	250	500	1K	2K	4K	8K
K_{ok}	10	6	2	-3	-5	-11	-20	-31

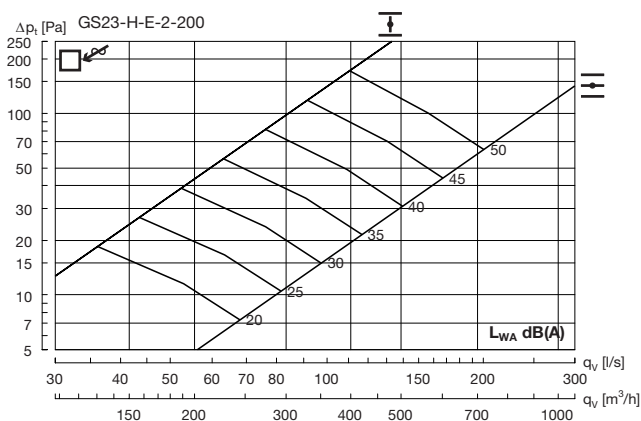

Hz	63	125	250	500	1K	2K	4K	8K
K_{ok}	8	5	4	-2	-8	-11	-19	-24



Most of us spend the majority of our time indoors. Indoor climate is crucial to how we feel, how productive we are and if we stay healthy.

We at Lindab have therefore made it our most important objective to contribute to an indoor climate that improves people's lives. We do this by developing energy-efficient ventilation solutions and durable building products. We also aim to contribute to a better climate for our planet by working in a way that is sustainable for both people and the environment.

[Lindab | For a better climate](#)