

Damper with flow meter

DIRBU

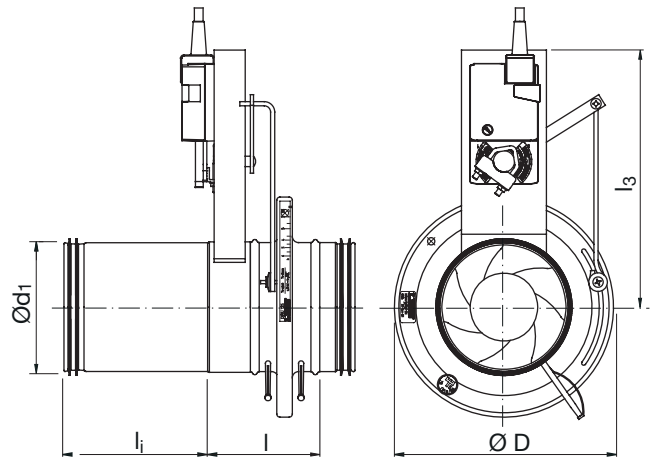

Dimensions



Ød ₁ nom	ØD nom	l [mm]	l _i [mm]	l ₃ [mm]	m [kg]
100	163	94	130	235	1,65
125	210	103	130	249	2,05
150	230	100	130	262	2,25
160	230	100	130	268	2,25
200	285	102	130	289	3,15
250	333	123	185	315	4,05
300	406	123	185	341	4,65
315	406	123	185	350	5,05

Description

The motor-driven damper DIRBU with flow meter is suitable for systems where it should be possible to increase the air flow or lower it to the basic level. Examples of such systems are conference rooms and public areas.

It fulfills tightness class C. DIRBU is intended for use where you want to be able to set two air flows.

Maximum and minimum flow is set with the measurement nozzles and are fixed with the two end stop screws on the motor.

There is a separate assembly, measuring, balancing and maintenance instruction for this product.

Ø 100–315 fulfills pressure class A in closed position.

Cleaning

By fully open the damper, one get access to the duct. Do not forget to readjust the damper after cleaning.

Installation

Consider required straight distance after or before disturbance, as mentioned on page 2 and on the card attached to the measurement nozzles, to obtain accurate flow measurement.

End stop screws

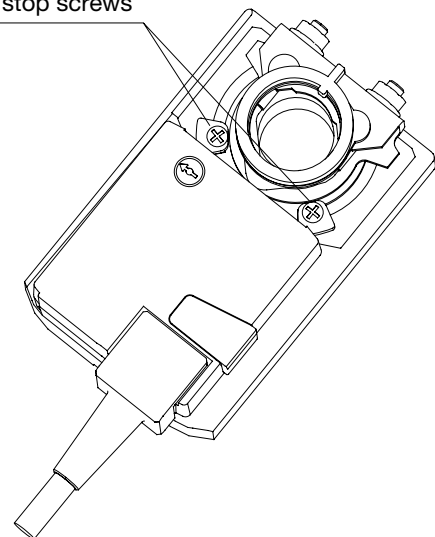

Ordering example

	DIRBU	160	24	LM
Product				
Dimension Ød ₁				
Voltage				
Motor type				



Damper with flow meter

DIRBU

Technical data for the motors

	LM 24 A	LM 230 A
Power supply.....	AC 19,2–28,8 V, 50/60 Hz DC 19,2–28,8 V	AC 85–265 V, 50/60 Hz
Power consumption	1 W	1,5 W
For wire sizing	2 VA	4 VA
Connection	Cable 1 m, 3×0,75 mm ²	Cable 1 m, 3×0,75 mm ²
Operating angle.....	Max. 95°, adjustable 0–100%	Max. 95°, adjustable 0–100%
Torque at rated voltage	Min. 5 Nm	Min. 5 Nm
Direction of rotation.....	Switch selectable 0 ↺ or 1 ↻	Switch selectable 0 ↺ or 1 ↻
Position indication	Mechanical	Mechanical
Running time for 95°	150 s	150 s
Sound power level.....	Max. 35 dB (A)	Max. 35 dB (A)
Protection class.....	III Safety extra-low voltage	II Safety insulated
Protection type.....	IP 54	IP 54
Ambient temperature range	-30 to +50°C	-30 to +50°C
Ambient moisture	95 % RF	95 % RF

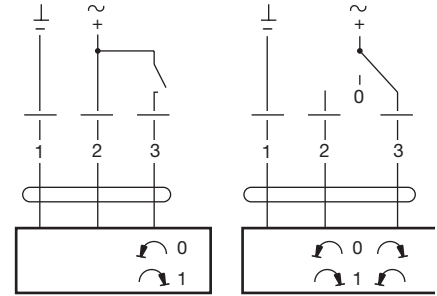

Damper with flow meter

DIRU, DIRBU, DIRVU

Pressure drop graphs with noise data for dimensioning

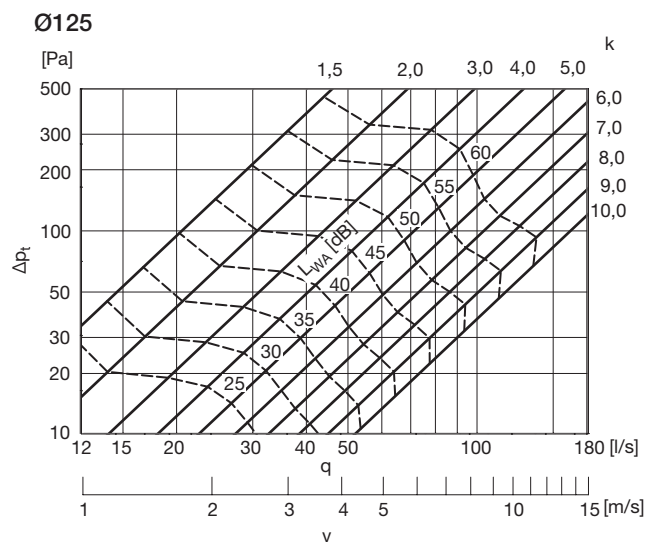
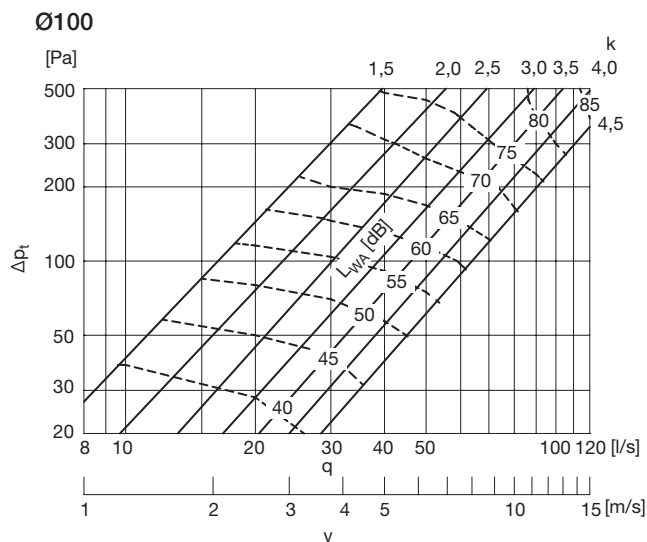
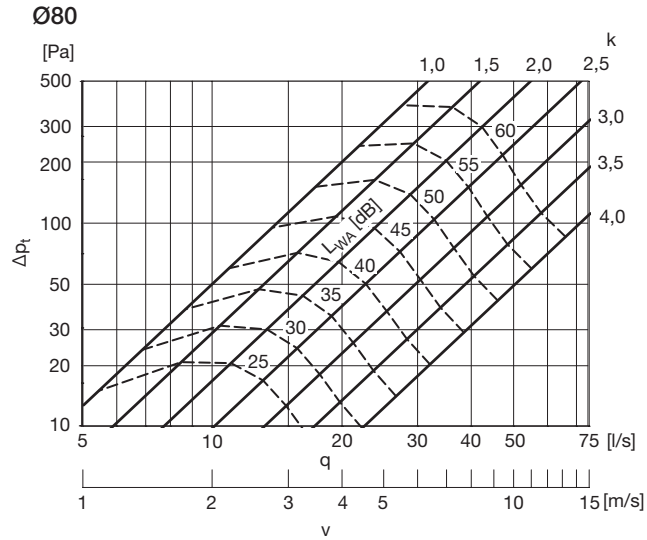

Flow graphs for balancing

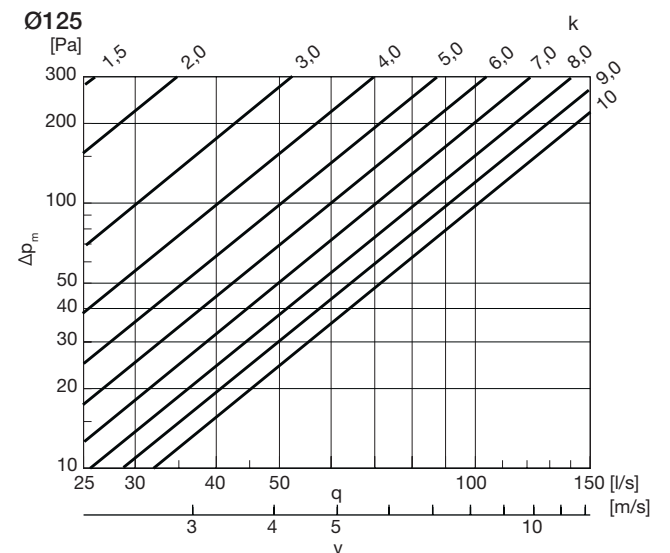
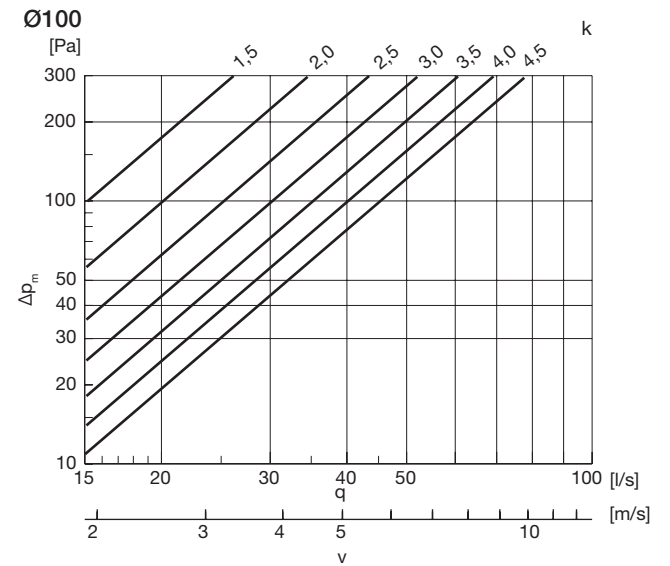
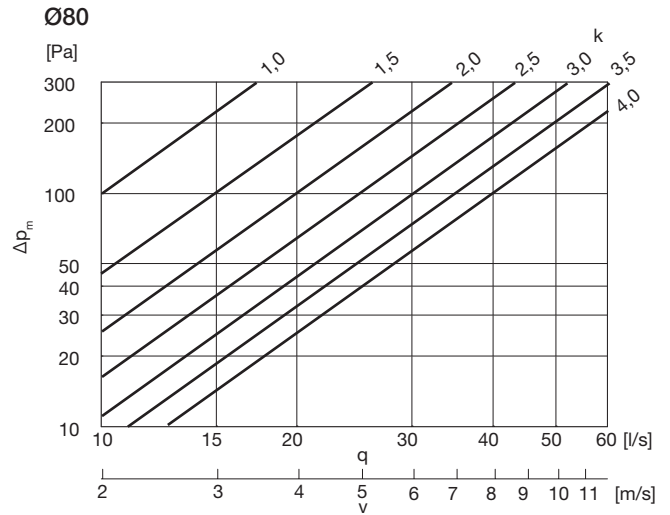

Damper with flow meter

DIRU, DIRBU, DIRVU

Pressure drop graphs with noise data for dimensioning

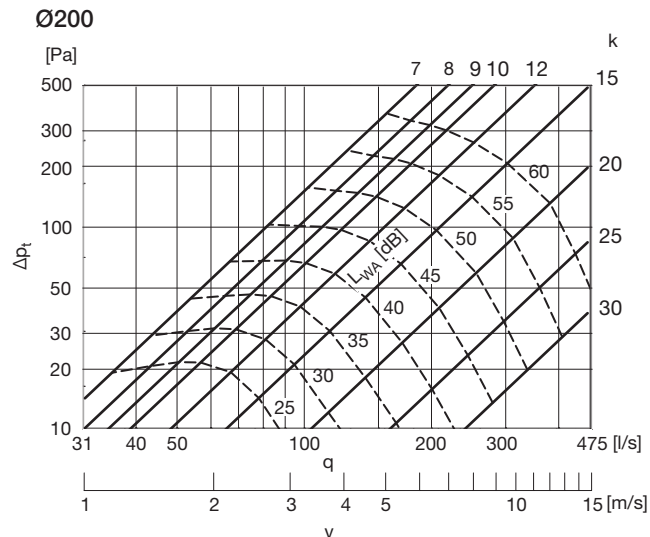
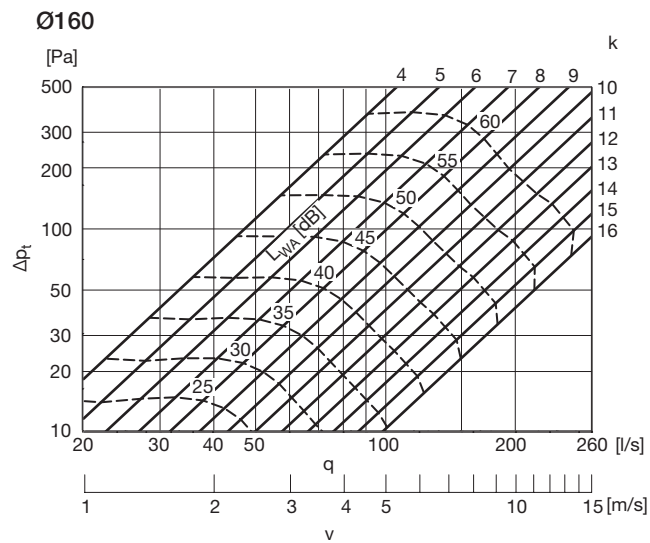
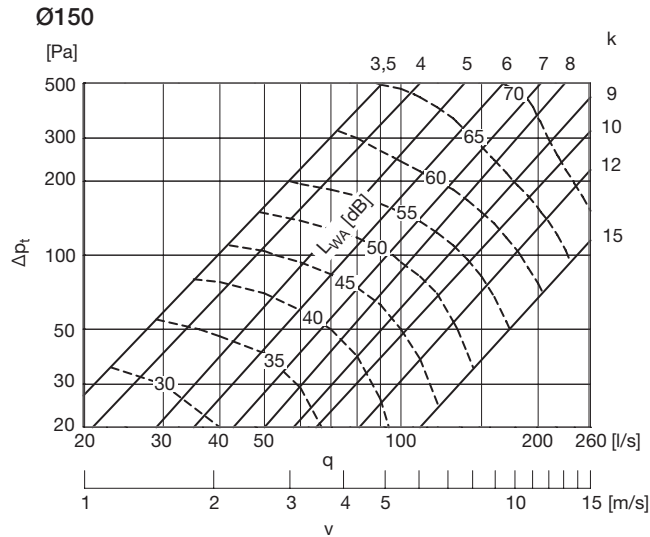

Flow graphs for balancing

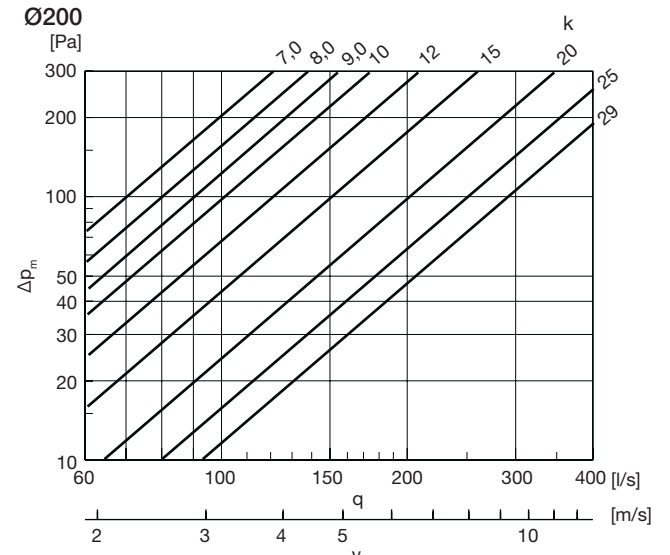
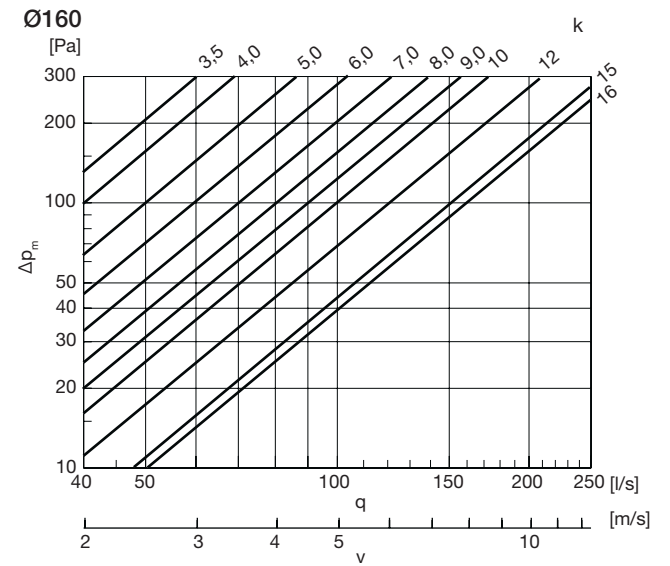
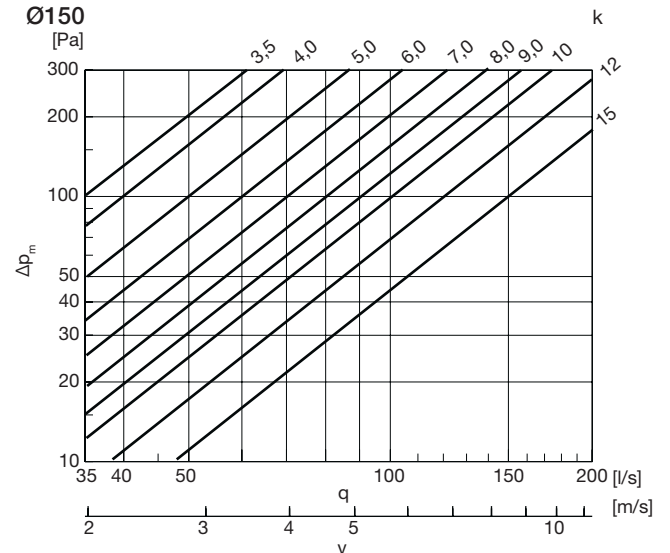

Damper with flow meter

DIRU, DIRBU, DIRVU

Pressure drop graphs with noise data for dimensioning

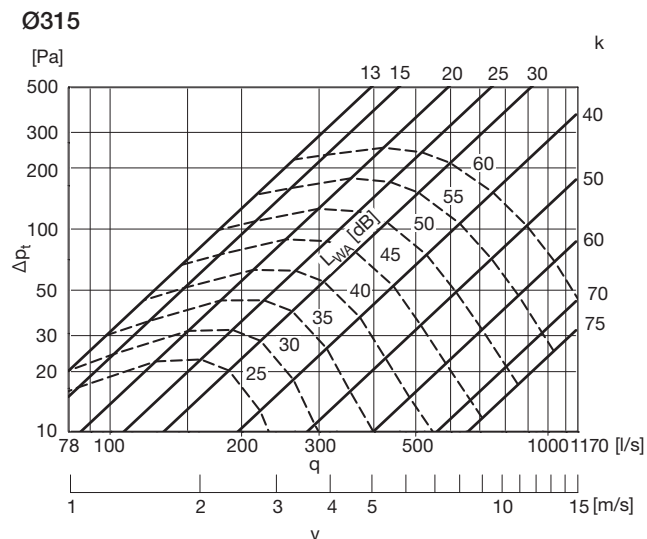
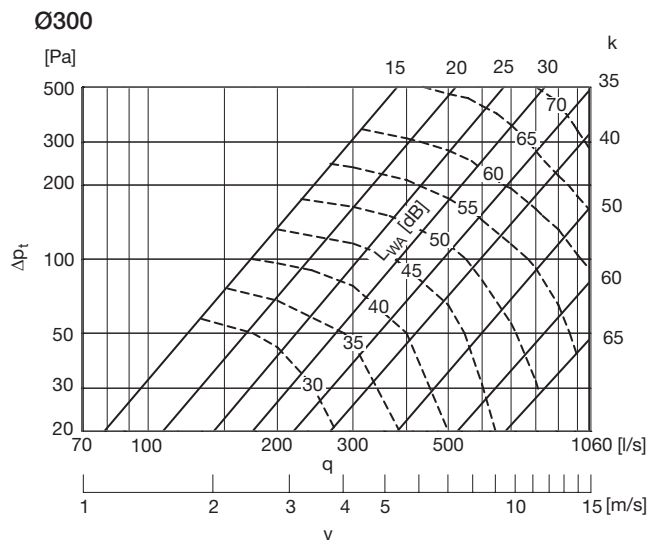
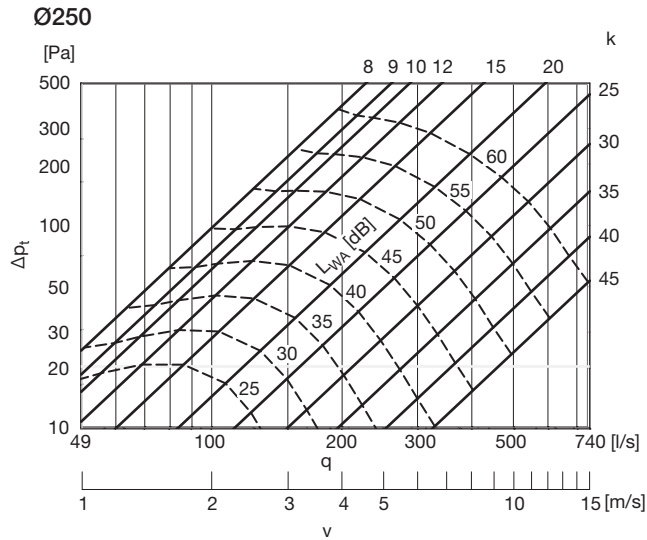

Flow graphs for balancing

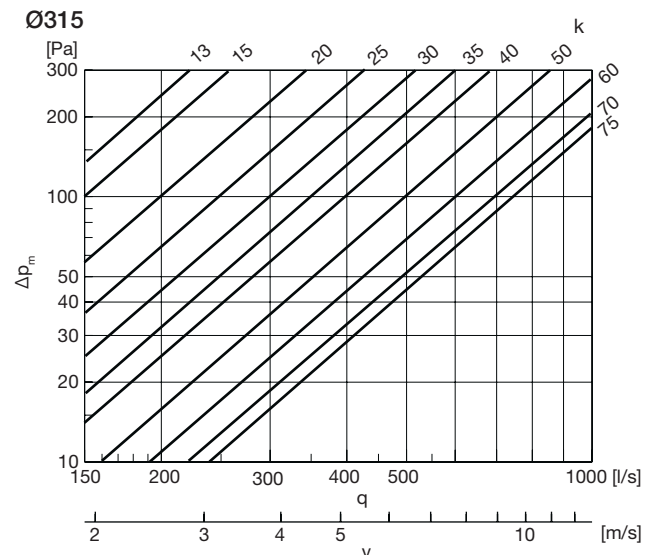
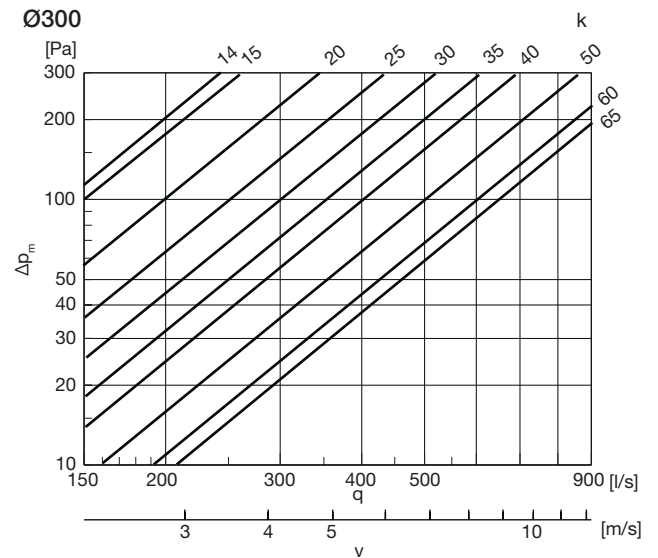
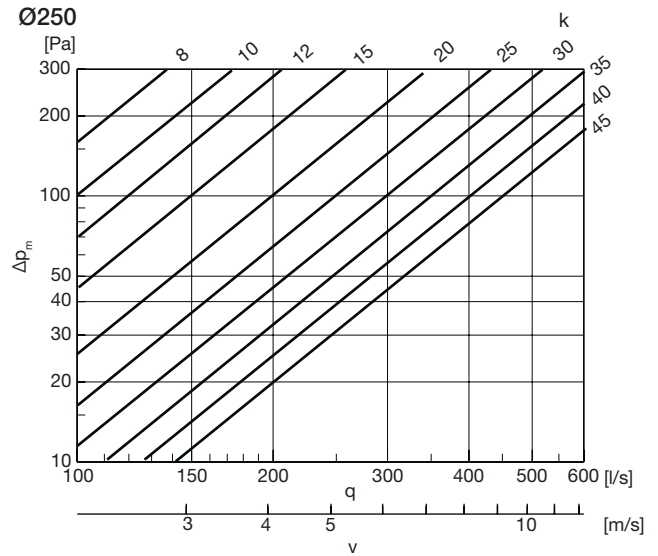

Damper with flow meter

DIRU, DIRBU, DIRVU

Pressure drop graphs with noise data for dimensioning

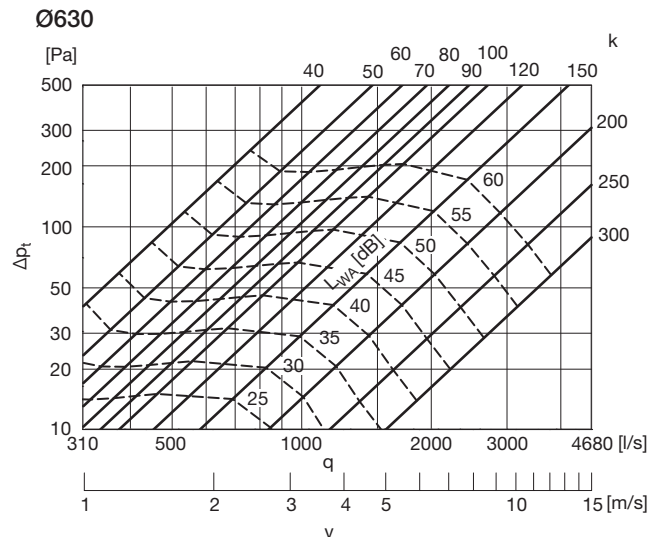
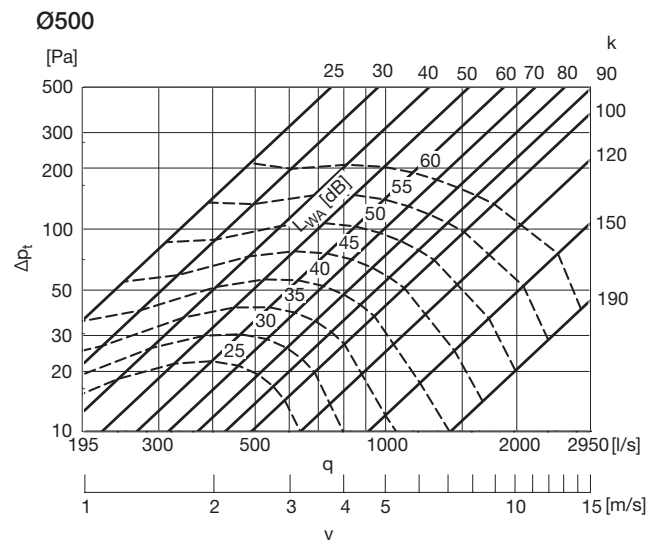
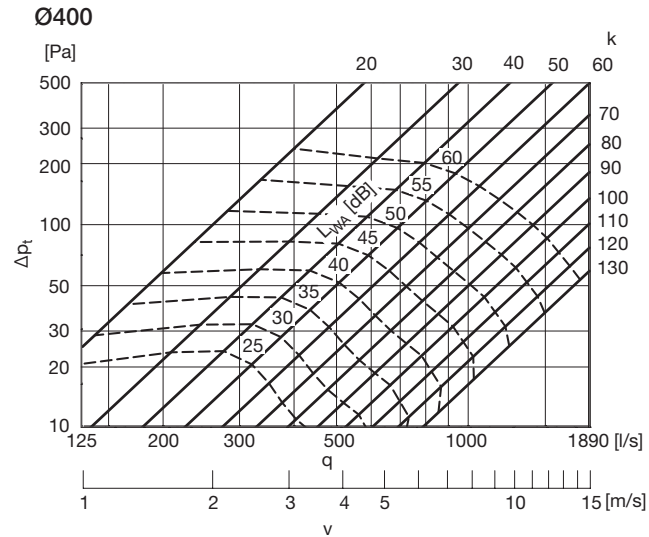

Flow graphs for balancing

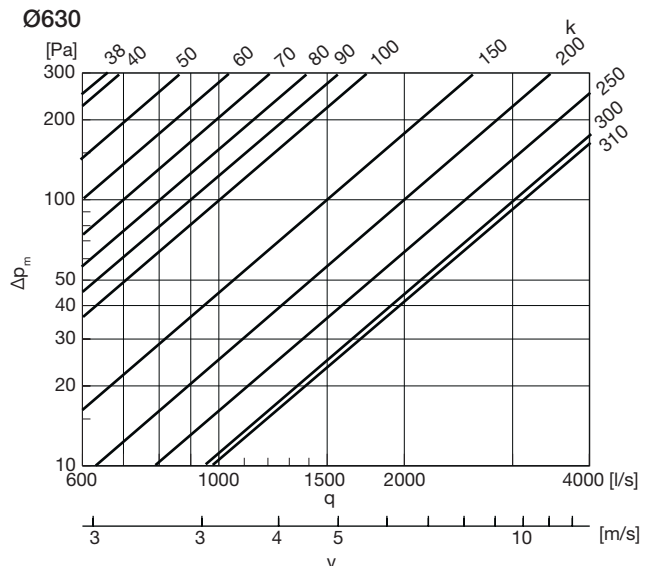
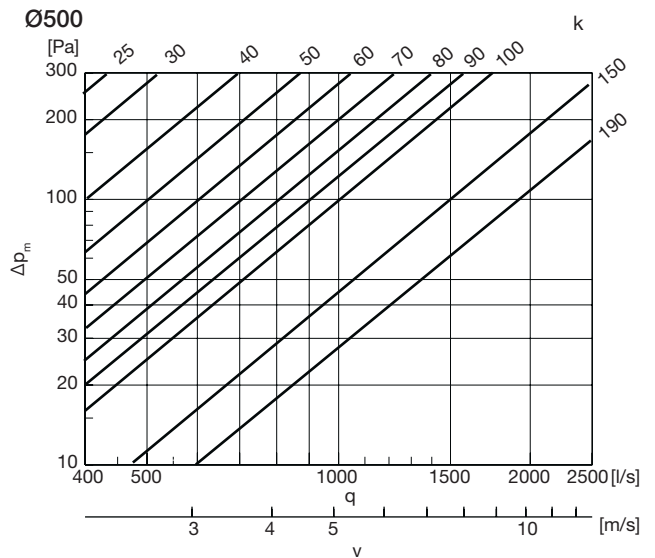
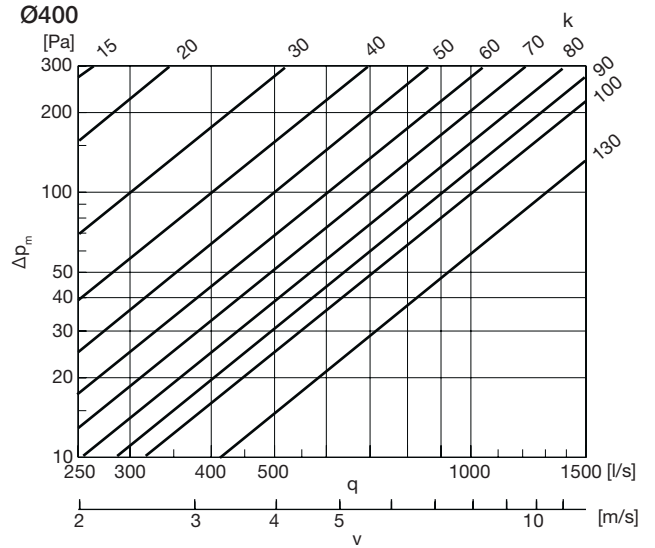

Damper with flow meter

DIRU, DIRBU, DIRVU

Sound data

Sound power level L_w , [dB] to duct in the octave bands 1–8, 63–8000 Hz, as a function of dimension, flow and pressure drop. Note: A-filter have to be applied to the figures in the table if $L_w(A)$ is to be calculated.

A-filter correction

63	125	250	500	1K	2K	4K	8K
-26	-16	-9	-3	0	1	1	-1

dim $\varnothing d_1$	Pressure loss [Pa]	Centre frequency [Hz]								Centre frequency [Hz]								Centre frequency [Hz]							
		63	125	250	500	1k	2k	4k	8k	63	125	250	500	1k	2k	4k	8k	63	125	250	500	1k	2k	4k	8k
80		Velocity app. 1 [m/s]								Velocity app. 3 [m/s]								Velocity app. 6 [m/s]							
		Flow 5 [l/s]								Flow 15 [l/s]								Flow 30 [l/s]							
	500									54	54	48	40	36	35	31	22	61	62	57	49	45	43	39	27
	200									47	45	38	31	27	26	23	16	57	57	52	44	40	39	34	24
	100									41	37	30	24	20	19	16	11	54	53	48	40	36	35	31	22
	50																	50	48	42	35	31	29	26	18
	20																								
		Velocity app. 9 [m/s]								Velocity app. 12 [m/s]								Velocity app. 15 [m/s]							
		Flow 45 [l/s]								Flow 60 [l/s]								Flow 75 [l/s]							
	500	70	73	68	60	55	54	48	34	73	77	72	64	59	58	52	36	76	81	77	68	63	62	55	39
200	66	68	63	54	50	49	44	31	70	73	68	59	55	54	48	34	73	77	72	63	59	57	51	36	
100	63	64	59	51	46	45	40	28	66	69	64	55	51	50	44	31	69	72	67	58	54	53	47	33	
50	59	60	54	47	42	41	37	26	62	64	58	50	46	45	40	28									
20																									

dim $\varnothing d_1$	Pressure loss [Pa]	Centre frequency [Hz]								Centre frequency [Hz]								Centre frequency [Hz]							
		63	125	250	500	1k	2k	4k	8k	63	125	250	500	1k	2k	4k	8k	63	125	250	500	1k	2k	4k	8k
100		Velocity app. 1 [m/s]								Velocity app. 3 [m/s]								Velocity app. 6 [m/s]							
		Flow 8 [l/s]								Flow 24 [l/s]								Flow 47 [l/s]							
	500									52	52	47	41	38	36	32	24	67	71	68	62	59	57	51	38
	200									45	43	38	32	29	27	24	18	59	61	57	51	47	45	41	30
	100									40	37	31	26	22	21	18	13	55	56	51	45	42	40	36	27
	50																	53	53	48	42	39	37	33	25
	20																								
		Velocity app. 9 [m/s]								Velocity app. 12 [m/s]								Velocity app. 15 [m/s]							
		Flow 71 [l/s]								Flow 94 [l/s]								Flow 118 [l/s]							
	500	67	72	69	63	59	57	51	38	69	75	71	66	62	60	54	40	72	78	74	69	65	63	56	42
200	62	65	61	56	52	50	45	33	68	72	69	63	60	58	52	38									
100																									
50																									
20																									

dim $\varnothing d_1$	Pressure loss [Pa]	Centre frequency [Hz]								Centre frequency [Hz]								Centre frequency [Hz]							
		63	125	250	500	1k	2k	4k	8k	63	125	250	500	1k	2k	4k	8k	63	125	250	500	1k	2k	4k	8k
125		Velocity app. 1 [m/s]								Velocity app. 3 [m/s]								Velocity app. 6 [m/s]							
		Flow 12 [l/s]								Flow 37 [l/s]								Flow 74 [l/s]							
	500									70	62	56	50	43	39	35	26	82	74	68	62	55	50	45	33
	200									63	54	48	42	36	32	29	21	73	65	59	53	46	41	38	28
	100									56	47	40	34	29	25	23	17	69	61	55	49	43	38	35	25
	50									50	41	34	28	23	20	18	13	66	57	51	45	39	35	31	23
	20																	61	53	46	40	35	31	28	20
		Velocity app. 9 [m/s]								Velocity app. 12 [m/s]								Velocity app. 15 [m/s]							
		Flow 110 [l/s]								Flow 147 [l/s]								Flow 184 [l/s]							
	500	84	76	70	64	57	51	47	34	88	80	75	69	62	56	51	37	93	85	80	73	66	60	55	40
200	80	71	66	60	53	48	43	32	84	76	71	64	57	52	47	35	86	78	72	66	59	53	49	36	
100																									
50																									
20																									



Damper with flow meter

DIRU, DIRBU, DIRVU

dim Ød ₁	Pressure loss [Pa]	Centre frequency [Hz]							Centre frequency [Hz]							Centre frequency [Hz]																							
		63	125	250	500	1k	2k	4k	8k	63	125	250	500	1k	2k	4k	8k	63	125	250	500	1k	2k	4k	8k														
150		Velocity app. 1 [m/s]							Velocity app. 3 [m/s]							Velocity app. 6 [m/s]																							
		Flow 20 [l/s]							Flow 50 [l/s]							Flow 110 [l/s]																							
	300															85	79	67	57	49	41	32	29	78	72	60	50	42	34	25	22	71	65	53	43	35	27	18	15
	200															64	58	46	36	28	20	12	9	56	50	38	28	20	12	5	4	66	60	48	38	30	22	13	10
	100															51	45	33	23	15	7	3	3	62	56	44	34	26	18	9	6								
	50	45	39	27	17	9	1	1	1																														
	20																																						
		Velocity app. 9 [m/s]							Velocity app. 12 [m/s]							Velocity app. 15 [m/s]																							
		Flow 160 [l/s]							Flow 210 [l/s]							Flow 260 [l/s]																							
	300	89	83	71	61	53	45	36	33	92	86	74	64	56	48	39	36	94	88	76	66	58	50	41	38														
200	83	77	65	55	47	39	30	27	87	81	69	59	51	43	34	31	91	85	73	63	55	47	38	35															
100	77	71	59	49	41	33	24	21	82	76	64	54	46	38	29	26	87	81	69	59	51	43	34	31															
50	73	67	55	45	37	29	20	17																															
20																																							

dim Ød ₁	Pressure loss [Pa]	Centre frequency [Hz]							Centre frequency [Hz]							Centre frequency [Hz]																							
		63	125	250	500	1k	2k	4k	8k	63	125	250	500	1k	2k	4k	8k	63	125	250	500	1k	2k	4k	8k														
160		Velocity app. 1 [m/s]							Velocity app. 3 [m/s]							Velocity app. 6 [m/s]																							
		Flow 20 [l/s]							Flow 60 [l/s]							Flow 121 [l/s]																							
	500															72	69	62	56	57	58	47	36	65	61	54	48	48	49	40	30	61	57	50	43	43	44	36	27
	200															58	53	46	40	39	40	32	25	52	46	39	33	32	32	26	20	58	53	46	40	39	40	32	25
	100															46	39	32	26	25	20	15	53	48	40	34	34	34	27	21									
	50	43	36	28	23	21	21	16	12																														
	20																																						
		Velocity app. 9 [m/s]							Velocity app. 12 [m/s]							Velocity app. 15 [m/s]																							
		Flow 181 [l/s]							Flow 241 [l/s]							Flow 302 [l/s]																							
	500	73	71	63	57	58	59	48	37	76	74	67	60	61	63	52	39	79	77	70	63	65	66	54	41														
200	69	66	59	52	53	54	44	33	72	69	62	56	56	58	47	36	74	71	64	58	58	60	49	37															
100	66	62	55	48	48	49	40	31	68	65	58	51	52	53	43	33	72	69	62	55	56	57	47	36															
50	62	58	50	44	44	45	37	28	68	65	58	51	52	53	43	33																							
20																																							

dim Ød ₁	Pressure loss [Pa]	Centre frequency [Hz]							Centre frequency [Hz]							Centre frequency [Hz]																							
		63	125	250	500	1k	2k	4k	8k	63	125	250	500	1k	2k	4k	8k	63	125	250	500	1k	2k	4k	8k														
200		Velocity app. 1 [m/s]							Velocity app. 3 [m/s]							Velocity app. 6 [m/s]																							
		Flow 31 [l/s]							Flow 84 [l/s]							Flow 188 [l/s]																							
	500															70	67	63	60	59	56	49	41	63	59	54	52	50	47	41	34	58	54	49	46	44	41	35	30
	200															55	50	45	41	40	37	32	27	48	42	36	33	31	29	24	21	55	49	44	41	39	37	31	27
	100															42	35	29	25	23	21	18	15	51	45	40	36	34	32	27	23								
	50																																						
	20																																						
		Velocity app. 9 [m/s]							Velocity app. 12 [m/s]							Velocity app. 15 [m/s]																							
		Flow 283 [l/s]							Flow 377 [l/s]							Flow 471 [l/s]																							
	500	72	70	66	63	62	59	51	43	75	72	68	66	65	62	53	45	76	74	70	68	67	64	55	46														
200	66	63	58	55	54	51	44	37	69	66	61	59	58	55	47	40	71	68	64	62	61	58	50	42															
100	62	58	54	51	49	46	40	34	66	62	58	55	54	51	44	37	69	66	61	59	58	55	47	40															
50	60	55	50	47	46	43	37	31	64	60	55	52	51	48	41	35	67	64	59	57	55	52	45	38															
20	56	52	46	43	42	39	33	28																															

dim Ød ₁	Pressure loss [Pa]	Centre frequency [Hz]							Centre frequency [Hz]							Centre frequency [Hz]																							
		63	125	250	500	1k	2k	4k	8k	63	125	250	500	1k	2k	4k	8k	63	125	250	500	1k	2k	4k	8k														
250		Velocity app. 1 [m/s]							Velocity app. 3 [m/s]							Velocity app. 6 [m/s]																							
		Flow 49 [l/s]							Flow 147 [l/s]							Flow 295 [l/s]																							
	500															79	74	66	60	58	56	48	37	71	65	57	52	50	47	40	31	66	59	51	46	44	42	35	27
	200															62	55	47	42	39	37	31	24	62	55	47	42	39	37	31	24								
	100															57	50	42	37	35	33	27	21																
	50	44	36	28	22	20	18	15	11																														
	20																																						
		Velocity app. 9 [m/s]							Velocity app. 12 [m/s]							Velocity app. 15 [m/s]																							
		Flow 442 [l/s]							Flow 589 [l/s]							Flow 736 [l/s]																							
	500	82	77	69	64	62	59	51	39	85	80	72	66	65	62	53	41	87	82	74	69	67	64	55	42														
200	75	69	61	56	54	52	44	34	79	73	65	60	58	55	47	36	81	76	68	62	60	58	50	38															
100	71	65	57	51	49	47	40	31	75	69	61	55	53	51	44	33	78	72	64	59	57	54	46	35															
50	67	61	53	48	45	43	37	28	72	65	58	52	50	48	41	31	75	69	61	55	53	51	43	33															
20	63	56	49	43	41	39	33	25																															



Damper with flow meter

DIRU, DIRBU, DIRVU

dim Ød ₁	Pressure loss [Pa]	Centre frequency [Hz]							Centre frequency [Hz]							Centre frequency [Hz]									
		63	125	250	500	1k	2k	4k	8k	63	125	250	500	1k	2k	4k	8k	63	125	250	500	1k	2k	4k	8k
300		Velocity app. 1 [m/s]							Velocity app. 3 [m/s]							Velocity app. 6 [m/s]									
		Flow 70 [l/s]							Flow 210 [l/s]							Flow 420 [l/s]									
	300								70	62	53	51	44	39	30	29	82	74	65	63	56	51	42	41	
	200								59	51	42	40	33	28	19	18	73	65	56	54	47	42	33	32	
	100								49	41	32	30	23	18	9	8	64	56	47	45	38	33	24	23	
	50								42	34	25	23	16	11	3	2	58	50	41	39	32	27	18	17	
	20	33	25	16	14	7	4	2	1									53	45	36	34	27	22	13	12
		Velocity app. 9 [m/s]							Velocity app. 12 [m/s]							Velocity app. 15 [m/s]									
		Flow 640 [l/s]							Flow 850 [l/s]							Flow 1060 [l/s]									
	300	84	76	67	65	58	53	44	43	88	80	71	69	62	57	48	47	92	84	75	73	66	61	52	51
200	77	69	60	58	51	46	37	36	81	73	64	62	55	50	41	40	85	77	68	66	59	54	45	44	
100	70	62	53	51	44	39	30	29	74	66	57	55	48	43	34	33	78	70	61	59	52	47	38	37	
50	66	58	49	47	40	35	26	25	70	62	53	51	44	39	30	29	74	66	57	55	48	43	34	33	
20	62	54	45	43	36	31	22	21																	

dim Ød ₁	Pressure loss [Pa]	Centre frequency [Hz]							Centre frequency [Hz]							Centre frequency [Hz]									
		63	125	250	500	1k	2k	4k	8k	63	125	250	500	1k	2k	4k	8k	63	125	250	500	1k	2k	4k	8k
315		Velocity app. 1 [m/s]							Velocity app. 3 [m/s]							Velocity app. 6 [m/s]									
		Flow 78 [l/s]							Flow 234 [l/s]							Flow 468 [l/s]									
	500																75	71	67	65	65	64	57	46	
	200																65	60	55	53	52	51	45	37	
	100								57	51	46	43	42	41	36	29	59	54	49	46	45	44	39	32	
	50								48	41	36	32	31	30	26	21	55	49	44	41	40	39	34	28	
	20	43	36	28	23	21	21	16	12	42	34	28	24	22	21	18	15	52	45	40	36	35	34	30	25
		Velocity app. 9 [m/s]							Velocity app. 12 [m/s]							Velocity app. 15 [m/s]									
		Flow 701 [l/s]							Flow 935 [l/s]							Flow 1169 [l/s]									
	500	75	71	68	66	66	65	57	47	77	73	70	68	68	67	59	48	79	75	72	70	71	70	61	50
200	68	63	59	57	56	55	49	40	71	66	63	60	60	59	52	42	73	69	65	63	63	62	55	45	
100	64	59	54	52	51	50	44	36	67	62	58	56	55	54	48	39	70	65	61	59	59	58	51	42	
50	60	55	51	48	47	46	40	33	64	59	55	52	51	50	44	36	67	62	58	56	55	54	48	39	
20	57	51	46	43	42	41	36	29	61	55	51	48	47	46	40	33									

dim Ød ₁	Pressure loss [Pa]	Centre frequency [Hz]							Centre frequency [Hz]							Centre frequency [Hz]									
		63	125	250	500	1k	2k	4k	8k	63	125	250	500	1k	2k	4k	8k	63	125	250	500	1k	2k	4k	8k
400		Velocity app. 1 [m/s]							Velocity app. 3 [m/s]							Velocity app. 6 [m/s]									
		Flow 126 [l/s]							Flow 377 [l/s]							Flow 754 [l/s]									
	500																86	80	74	70	69	67	56	45	
	200								72	65	59	54	53	51	43	34	76	69	64	59	58	56	47	37	
	100								63	55	49	44	43	41	34	27	71	63	57	53	52	49	41	33	
	50								52	44	37	33	31	29	24	19	66	58	52	48	46	44	37	29	
	20	42	33	27	22	19	18	14	11	44	35	28	24	21	20	16	13	62	54	48	44	42	40	33	26
		Velocity app. 9 [m/s]							Velocity app. 12 [m/s]							Velocity app. 15 [m/s]									
		Flow 1131 [l/s]							Flow 1508 [l/s]							Flow 1885 [l/s]									
	500	86	80	74	70	69	67	56	45	88	82	76	72	71	69	58	46	90	83	78	74	73	71	60	47
200	76	69	64	59	58	56	47	37	79	72	67	63	61	59	50	40	82	75	70	65	64	62	52	41	
100	71	63	57	53	52	49	41	33	74	67	61	57	56	54	45	36	78	70	65	61	59	57	48	38	
50	66	58	52	48	46	44	37	29	70	63	57	52	51	49	41	33									
20																									

dim Ød ₁	Pressure loss [Pa]	Centre frequency [Hz]							Centre frequency [Hz]							Centre frequency [Hz]									
		63	125	250	500	1k	2k	4k	8k	63	125	250	500	1k	2k	4k	8k	63	125	250	500	1k	2k	4k	8k
500		Velocity app. 1 [m/s]							Velocity app. 3 [m/s]							Velocity app. 6 [m/s]									
		Flow 196 [l/s]							Flow 589 [l/s]							Flow 1178 [l/s]									
	500																76	72	68	69	68	65	60	49	
	200								67	61	57	57	56	53	49	40	67	62	58	57	56	53	49	41	
	100								58	52	47	46	44	41	38	32	61	55	50	49	48	45	41	34	
	50								49	42	37	34	33	30	28	23	55	49	44	42	41	38	35	29	
	20	43	36	30	27	25	23	21	17	41	33	27	24	22	20	18	15	51	44	39	37	35	33	30	25
		Velocity app. 9 [m/s]							Velocity app. 12 [m/s]							Velocity app. 15 [m/s]									
		Flow 1767 [l/s]							Flow 2356 [l/s]							Flow 2945 [l/s]									
	500	78	74	71	72	71	68	63	51	81	77	73	74	74	70	65	53	82	78	75	76	76	72	67	55
200	70	65	61	61	60	57	53	43	72	67	63	64	63	60	55	45	74	69	65	66	65	62	57	47	
100	64	59	54	54	53	50	46	38	67	62	58	57	57	53	49	41	70	65	61	61	60	57	53	43	
50	60	54	50	49	47	44	41	34	64	59	54	54	53	50	46	38	68	63	58	58	57	54	50	41	
20	57	51	46	44	43	40	37	31																	



Damper with flow meter

DIRU, DIRBU,
DIRVU

dim Ød ₁	Pressure loss [Pa]	Centre frequency [Hz]								Centre frequency [Hz]								Centre frequency [Hz]								
		63	125	250	500	1k	2k	4k	8k	63	125	250	500	1k	2k	4k	8k	63	125	250	500	1k	2k	4k	8k	
630		Velocity app. 1 [m/s]								Velocity app. 3 [m/s]								Velocity app. 6 [m/s]								
		Flow 238 [l/s]								Flow 848 [l/s]								Flow 1696 [l/s]								
	500									71	61	57	57	56	54	49	41	82	71	68	69	69	66	60	50	
	200									63	53	48	47	46	44	40	33	70	60	56	56	55	53	48	40	
	100									54	44	39	37	36	34	30	25	64	54	49	49	48	46	41	34	
	50									46	35	30	27	25	23	21	18	60	50	45	44	43	41	37	31	
	20	44	34	28	25	23	22	19	16									55	45	40	38	37	35	32	26	
			Velocity app. 9 [m/s]								Velocity app. 12 [m/s]								Velocity app. 15 [m/s]							
			Flow 2545 [l/s]								Flow 3393 [l/s]								Flow 4241 [l/s]							
	500		81	70	67	68	68	65	59	49	82	72	69	70	70	67	61	51	85	75	71	73	73	70	64	53
	200		73	63	59	59	59	56	51	42	77	67	63	63	63	61	55	46	80	70	66	67	67	64	58	48
	100		69	59	55	55	54	52	47	39	73	63	59	59	59	56	51	42	76	66	62	62	62	60	54	45
50		66	55	51	50	50	47	43	36																	
20																										

