

# Lindab Comdif



CSC, canteen, Copenhagen

## Lindab Comdif

By using displacement ventilation, the air is supplied to the room directly into the occupied zone at floor-level - at a low velocity and a cooling temperature. The air spreads out across the floor and displaces the hot contaminated air, which is sent to the ceiling by the convection flow from the heated sources. Extraction should take place by the ceiling, where a hot "contaminated" layer of air forms.

The increase in ventilation efficiency means that cooling power can be saved, or that the cooling effect of the fresh air can be utilized better.

The ventilation efficiency of displacement ventilation is larger than that of mixed ventilation, owing to this division of layers. The difference increases when the ceiling and thermal load are higher.

## Flexibility by displacement ventilation

Comdif is a series of air distribution diffusers for displacement ventilation. Comdif is available in various designs for any purpose and consists of a pressure chamber with a number of nozzles.

The diffusers are all equipped with adjustable nozzles, so it is possible to change the near-zones geometry. The diffuser comes standard supplied with a perforated frontplate with a free area of approx. 38%.

The diffusers are available in special designs with several different types of perforation, plate-thickness and choice of materials. The diffusers can also be constructed to fit other dimensions and different geometry on request.



CCA, circular displacement unit

# Lindab Comdif a series of displacement diffusers

## Design

See chapter on [Comfort and Design](#)

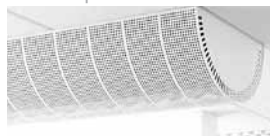

**Function**  
supp./exhau.

**Size**

## Accessories

See page [Accessories](#)



Product

**Perforated diffuser - semicircular** **mm**

**CBA**

1207  
1607  
2010  
2510  
3115  
4020  
5020

Duct cover      Connection duct      Plinth      Mounting bracket

**Perforated diffuser - semicircular** **mm**

**CHA**

1207  
1607  
2010  
2510  
3115  
4020  
5020  
6320

Duct cover      Connection duct      Plinth      Mounting bracket

**Perforated diffuser - corner** **mm**

**CQA**

1207  
1607  
2010  
2510  
3115  
4020

Duct cover      Connection duct      Plinth      Mounting bracket

**Perforated diffuser - rectangular** **mm**

**CRA**

3010  
5010  
8010  
8020

Connection duct      Plinth      Mounting bracket

**Perforated diffuser - built-in** **mm**

**CVA**

3005  
5005  
6005  
6008  
8008

Connection duct      Plinth      Mounting bracket

**Perforated diffuser - rectangular** **mm**

**CEA**

2010  
2510  
3115  
4015

Connection duct      Plinth      Mounting bracket

**Perforated diffuser - square** **mm**

**CKA**

2010  
2510  
3110  
4015  
5020  
6320

Connection duct      Plinth      Mounting bracket

**Perforated diffuser - circular** **mm**

**CCA**

1207  
1607  
2010  
2510  
3115  
4020  
5020  
6320

Connection duct      Plinth      Mounting bracket

# Comdif accessories

## Duct covers

### Duct cover Type 0

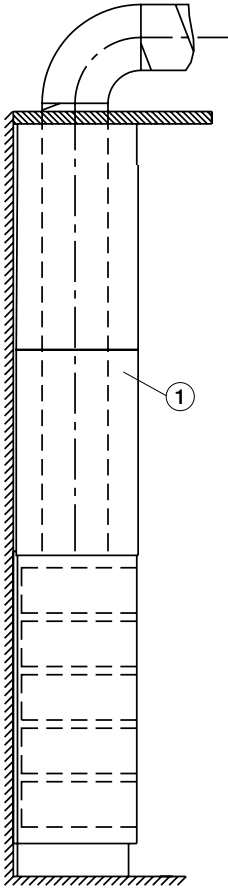

1. Duct cover

Duct covers are available for displacement diffusers type CBA,CHA,CQA from size 1207 to 3115.

### Type CHAZ-0, CQAZ-0 & CBAZ-0

Size	A mm	Max. room height mm	Min. room-height mm	m kg/m
1207	250	3300	2400	6,0
1607	300	3300	2400	7,5
2010	330	3300	2400	9,5
2510	400	3300	2400	12,0
3115	520	3200	2400	15,0

## Plinth CHAZ-2

Plinth CHAZ-2 is available in all sizes for free standing diffusers.

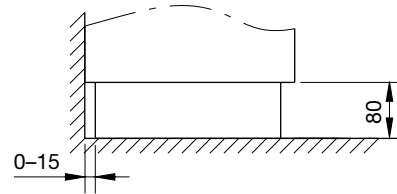

## Mounting bracket CHAZ-3

Mounting bracket CHAZ-3 is available in all sizes for free standing diffusers.

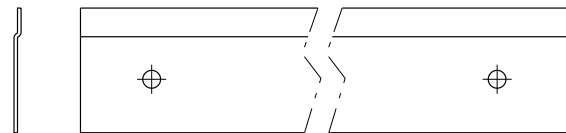

Comdif is equipped with pressure nozzles, which can be connected through pipes to a flow measuring device (FMI, FMDU, DIRU) or one similar inside the air duct system. The couplings are mounted behind the holes in the front plate, so the measurements can be taken without removing the front plate.

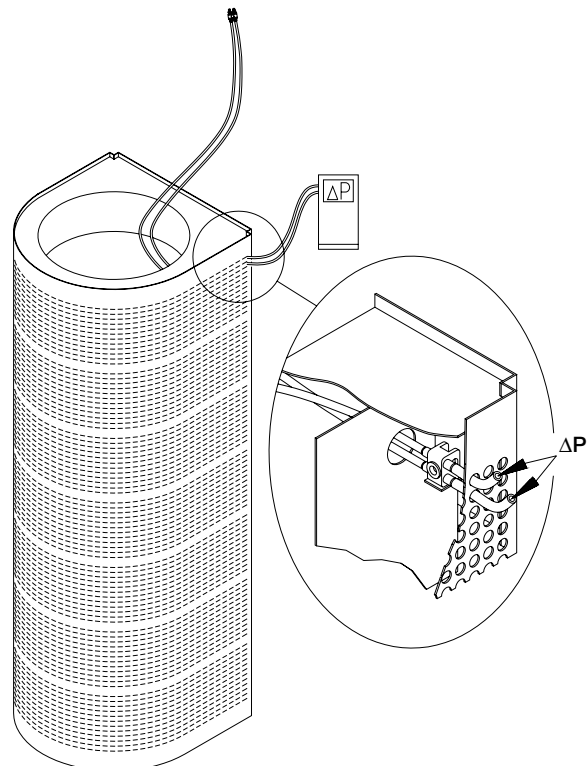

1  
2  
3  
4  
5  
6  
7  
8  
9  
10  
11  
12  
13  
14  
15  
16  
17  
18

# Displacement ventilation

## Displacement ventilation

A displacement unit should add a certain amount of air to properly ventilate the room, and at the same time meeting the requirements for sound level, air velocity and temperature gradient in the occupied zone. In order to meet these requirements, planning guidelines are needed, and the most important ones are stated hereafter. When choosing a unit, the demands on pressure loss, sound level and air throw should be made clear. These data can be found for each individual product. The selection- and performance data shown in Lindabs catalogue is the result of measurements carried out in Lindabs laboratory and are all conducted with modern and accurate measuring devices. In practice the conditions are rarely as ideal as in a laboratory, since the constructional environments, furnishing, placement of the air distribution units etc. has a great influence on the jet pattern spread in the room. Lindab attempts to test the conditions in practice by carrying out full-scale testing, which is often very valuable in the case of bigger and complicated tasks.

## Descriptions

$a_{0,2}$	Width of near-zone	[m]
$b_{0,2}$	Length of near-zone	[m]
$\epsilon_t$	Temperature efficiency	[-]
$K_{ok}$	Octave Correction value for sound power level	[dB]
$L_A$	A-balanced sound pressure level	[dB(A)]
$L_{WA}$	A-balanced sound power level	[dB(A)]
$L_{Wok}$	Sound power level in octave bands	[dB]
$L_p$	Sound pressure level	[dB]
$L_w$	Sound power level	[dB]
$\Delta L$	Sound attenuation	[dB]
$D$	Room attenuation	[dB]
$\Delta p_t$	Total pressure	[Pa]
$q$	Air flow	[m <sup>3</sup> /h], [l/s]
$t_i$	Supply air temperature	[°C]
$t_r$	Room temperature (1,1 m over the floor)	[°C]
$t_u$	Exhaust air temperature	[°C]
$\Delta t$	Temperature difference between room air and supply air	[K]
$v_x$	Velocity at distance x from the centre of the unit	[m/s]

## Vertical temperature distribution

Due to the stratified flow, displacement ventilation causes a big difference in temperature throughout the room. In comfort ventilation, where the heating sources are placed in the bottom part of the room, the temperature gradient, meaning the temperature rise per m (K/m) will be bigger in the lower part of the room, and smaller in the upper part.

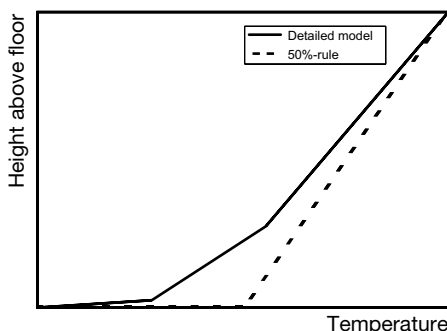

Fig. 17, Comparison of models for description of the vertical temperature distribution

The simplest models for description of the vertical temperature distribution are the so-called “%-rules”.

The most used one is the 50%-rule, in which it is assumed, that half of the temperature rise from supply air to exhaust air occurs at the floor, and the other half occurs up throughout the room (see Figure 17). The model is a good one, as a first evaluation of the most typical rooms and units, but because of the simplicity it does not precisely determine the temperature gradient in the occupied zone.

Lindab recommends the use of a more detailed model instead. One that describes the variation of the temperature gradient up through the room. A close assumption is that the temperature gradient in the occupied zone is half of the temperature difference between the room air and the supply air. The model is based on a number of full scale tests, and factors in the temperature efficiency and the fact that the temperature gradient is larger in the lower part of the room than in the upper part.

## Temperature efficiency

The efficiency in displacement ventilation is due to the stratification. The difference is increased at larger ceiling heights. The effect taken from the room is proportional to the temperature difference between supply air and exhaust air ( $t_u - t_i$ ).

Since the exhaust temperature ( $t_u$ ) is higher than the room temperature ( $t_r$ ) in displacement ventilation, the same effect can be taken from the room at a higher supply air temperature ( $t_i$ ) than with mixed ventilation, where  $t_u \leq t_r$ . This means that cooling effect can be spared, or that it is possible to use the cooling effect of the outer air more efficiently.

Displacement ventilation is furthermore partly self-regulating at varying thermal loads, because a rising load first and foremost will give a higher temperature gradient and consequently a higher temperature at the ceiling.

The temperature efficiency is given at:

$$\epsilon_t = \frac{t_u - t_i}{t_r - t_i} \times 100\%$$

With displacement ventilation it is the case that  $\epsilon_t > 100\%$  ( $t_u \geq t_r$ ),

while  $\epsilon_t \leq 100\%$  at mixed ventilation ( $t_u \leq t_r$ ).

By ideal mixing  $\epsilon_t = 100\%$  ( $t_u = t_r$ ).

## Pressure loss

The diagrams show the total pressure loss for the unit (at  $\rho = 1,2 \text{ kg/m}^3$ ), meaning the sum of static and dynamic pressure, connected to a straight air duct with a length of 1 m and the same dimension as the diffuser.

## Sound level

The diagrams show the A-balanced sound power level  $L_{WA}$  for a diffuser connected with a straight air duct with a length of 1 m and the same dimensions as the diffuser.

Sound pressure level is a measurement of the result of the sound, ie. the pressure vibrations we perceive, while the sound power level is a parameter to characterize the source of the sound. Both are normally noted in the unit dB (decibels), which can cause some confusion.

# Displacement ventilation

**Sound pressure (Lp)**

Is a measure of the intensity of the sound, characterized by pressure vibrations, perceived by the ear or measured with a microphone on a noise meter. Sound pressure is measured in Pascal (Pa) and is usually noted as sound pressure level in decibels (dB) or dB(A).

**Sound power (Lw)**

The power, a sound source (eg. a machine) sends out in the form of a sound. The sound effect is measured in Watt (W) and is usually noted as sound effect level in decibels (dB) or dB(A).

In Lindabs catalogue sound properties of the units are named sound power level.

Sound power level:  $L_w = 10 \times \log \frac{N}{N_{re}}$  [dB]

where N is the actual sound power [W], which is sent out in the shape of pressure vibrations and  $N_{re} = 10^{-12}$  W is the reference sound power.

Sound pressure level:  $L_p = 20 \times \log \frac{P}{P_{re}}$  [dB]

where p is the actual sound pressure [N/m<sup>2</sup>] and  $p_{re} = 2 \times 10^{-5}$  N/m<sup>2</sup> which is the reference sound pressure.

Room attenuation D [dB] is the difference between sound power level and sound pressure level.  $L_{wok} = L_w - D$

The A-balanced sound power level,  $L_{WA}$  is calculated to sound power level in the individual octave bands by :

$L_p = L_{WA} + K_{ok}$ ,

$K_{ok}$  being a correctional value.  $K_{ok}$  is specified in tabular form for each individual unit.

**Sound attenuation**

Specified for each individual diffuser, the reduction of sound power level from air duct to room (including end reflection).

**Near-zone**

The area around the unit, where the air velocity is above 0,2 m/s, is referred to as the near-zone.

The size of the near-zone is specified for each unit at a cooling temperature of  $\Delta t = t_r - t_i = 3K$ .

The near-zone length ( $a_o$ ) and – width ( $b_o$ ) is valid for evenly distributed thermal loads.

**Dimensioning displacement ventilation**

To plan a ventilation system by displacement principle, which “works” on the basis of thermal powers, and where the supply air is added directly to the occupied zone, makes special demands on dimensioning and placement of the air distribution units. They should, as such, never be placed directly by a powerful heating source, like a radiator. Powerful sunlight can also disturb the system, and in some cases make it function as a mixed ventilation system. Large, cold walls - or window surfaces in the room can also cause a back-flow of contaminated air to the occupied zone.

The system is not suitable for heating purposes, and consequently requires heating and ventilation to be separate. Exhaust should always take place as high up in the room as possible.

If in any doubt about a project, or if there are any points to be analysed, Lindab offers to test the conditions in practice by conducting full-scale tests, which is often of great value, at bigger and complicated tasks.

**Convection flow**

The supplied air flow should at least be the same as the total convection flow in the room (Figure 18). If the supplied air flow is less than this the convection flow will draw contaminated air from above down into the occupied zone (Figure 19).

The following factors affect the convection flow:

- The shape and surface of the heat source
- The surface temperature of the heat source
- Convective proportion of the heating output emitted
- Mean temperature of the room
- The level of the contaminated zone in relation to the level of the heat sources in the room

The convection flow from people, lighting, and machinery can be determined from the output and the placement of the heat sources in the room (see Table 1 and Table 2).

Table 1, Convection flows for people based on experiences

Activity	met	Heat output W	airflow l/s	
			1.2 above floor	1.8 above floor
Sitting, relaxing	1,0	100	8-10	-
Sitting activity	1,2	130	10-12	-
Light act., standing	1,6	170	-	25-30
Medium act., standing	2,0	200	-	30-35
High act. standing	3,0	300	-	35-40

Met: metabolism, 1 met = 58 W/m<sup>2</sup> body surface.

Table 2, Convection flows for various heat sources.

Heating source	Airflow	
	1.2 above floor	1.8 above floor
Table lamps	0,10	0,20
Ceiling lights	-	-
Machines	0,10	0,20
Sunlight	0,11	0,22

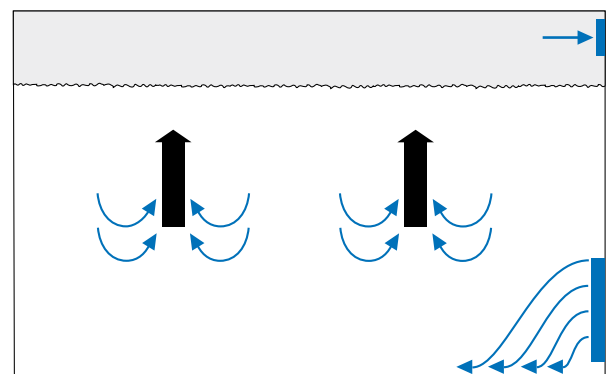

Fig. 18, Displacement ventilation with sufficient air flow.

1  
2  
3  
4  
5  
6  
7  
8  
9  
10  
11  
12  
13  
14  
15  
16  
17  
18

# Displacement ventilation

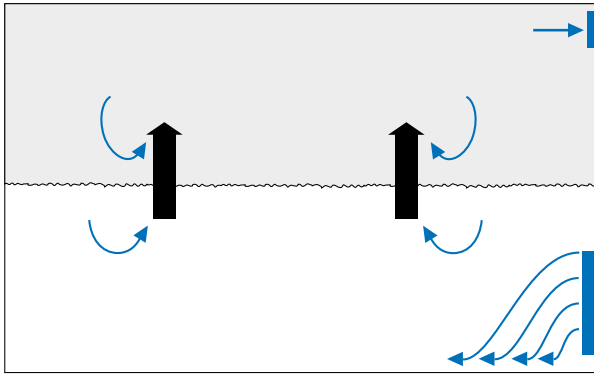

Fig. 19, Displacement ventilation with insufficient air flow.

## Temperature gradient

The demands made on thermal comfort in the occupied zone places a limit on the size of the temperature gradient. Table 3 show the maximum gradient recommended by Lindab Comfort at various levels of activity. Further more the corresponding maximum cooling temperature ( $t_r - t_i$ ) is mentioned when using Lindabs COMDIF-units. The temperature gradient in the occupied zone (K/m) can with a small margin be set at half of the cooling temperature  $t_r - t_i$  (K).

Table 3, Recommended temperature gradients and cooling temperatures

Activity	Max. temperature gradient (K/m)	Max. undertemperature $t_r - t_i$ (K)
Sitting, relaxing	1,5	3,0
Sitting activity	2,0	4,0
Light act., standing	2,5	5,0
Medium activity	3,0	6,0
High activity	3,5	7,0

## Near-zone

The size of the near-zone is specified for each unit in the catalogue. If several units are placed close to one another, the near-zone will increase (Figure 20).

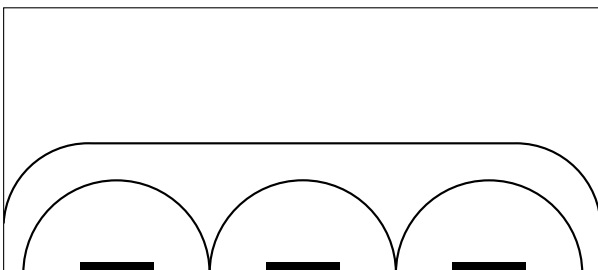

Fig. 20, Diffusers placed too close, limiting the individual diffusers induction.

A big air flow from one unit can result in a too big near-zone (Figure 21). If the air is instead distributed on two units, smaller near-zones are the result. (Figure 22).

To achieve the smallest possible near-zones, and thus the best possible use of the room, the air flow should be distributed evenly in the room with as many units as possible.

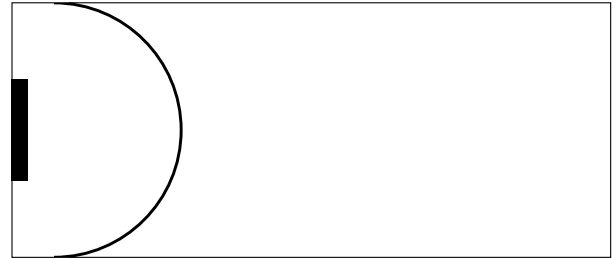

Fig. 21, Too great air flow on one diffuser results in a too big near zone.



Fig. 22, Less air flow per diffuser and smaller near zones.

## More units

When several units are placed too close to one another by the same wall, the near-zone is increased as shown in Figure 20, since jet streams can form between the units. In a certain distance from the units however, a continuous jet flow will be formed with a near constant velocity. This end-velocity is dependent on the total airflow per m wall and the cooling temperature. In Figure 23 this end-velocity can be read. It will often be an advantage to distribute the air on units placed on adjacent walls at a 90 degree angle. In this case, the units should also be placed evenly along the walls, since of course jets also form between too closely placed units around the corner of a wall.

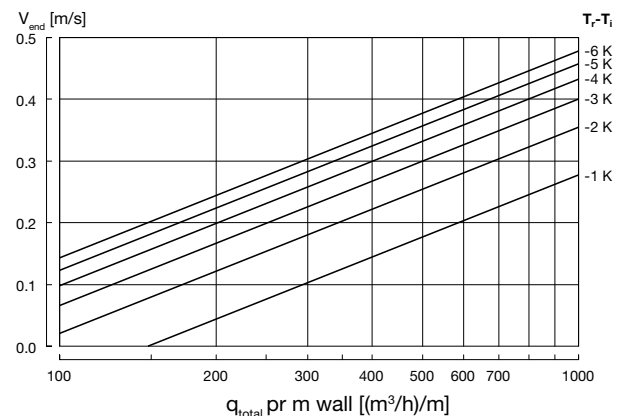

Fig. 23, End velocity at continuous jet flow.

# Displacement ventilation

## Output

In order to calculate the output which can be removed from the room by a displacement system, the temperature difference  $t_u - t_i$ , has to be known (depends on the thermal load, ceiling height and cooling temperature ( $t_r - t_i$ )).

By calculating the temperature efficiency and the necessary difference in temperature  $t_u - t_i$  the heating sources close to the ceiling (eg. lighting) are accounted for by 50% of the output.

From Figure 24 the temperature efficiency  $\epsilon_t$  can be read at different combinations of ceiling height and heat loads.

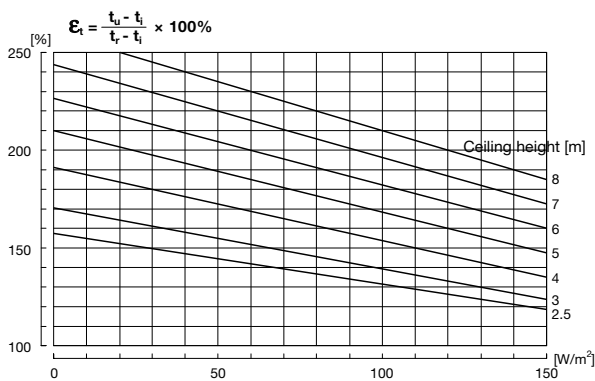

Fig. 24, Temperature efficiency is dependent on ceiling height and heat load.

## Calculation example

Room: L × B × H = 10 m × 6 m × 4 m

Thermal load:	
10 pers., sitting activity (10 × 130 W)	= 1300W (22 W/m <sup>2</sup> )
10 table lamps of 60 W (10 × 60 W)	= 600 W (10 W/m <sup>2</sup> )
10 machines of 100 W (10 × 100 W)	= 1000 W (17 W/m <sup>2</sup> )
<b>Total</b>	<b>= 2900 W (48 W/m<sup>2</sup>)</b>

Minimum air flow (from Table 1 and Table 2):

$q_{min} = 10 \text{ pers.} \times 11 \text{ l/s/pers.} + 10 \text{ table lamps} \times 60 \text{ W/table lamps} \times 0,1 \text{ l/s/W} + 10 \text{ machines} \times 100 \text{ W/machines} \times 0,1 \text{ l/s/W} = 270 \text{ l/s}$

Required temperature difference ( $t_u - t_i$ ):

$$t_u - t_i = \frac{2900 \text{ W}}{\frac{270 \text{ l/s}}{1000 \text{ l/m}^3} \times 1,2 \text{ kg/m}^3 \times 1007 \text{ J/kg/K}} = 8,9 \text{ K}$$

From Figure 24 the temperature efficiency can be read at  $\epsilon_t = 178 \%$  by a ceiling height of 4 m and a heat load of 48 W/m<sup>2</sup>.

Consequently the temperature difference  $t_r - t_i$  can be determined by using the formula:

$$\epsilon_t = \frac{t_u - t_i}{t_r - t_i} \Leftrightarrow t_r - t_i = \frac{t_u - t_i}{\epsilon_t} = \frac{8,9 \text{ K}}{1,78} = 5 \text{ K}$$

which gives a temperature gradient in the occupied zone of 2,5 K/m (since the temperature gradient in the occupied zone can be set to the half of the cooling temperature  $t_r - t_i$ ).

Lindab recommends a temperature gradient of <2 K/m and therefore the air flow should be increased.

A temperature gradient of 2 K/m gives  $t_r - t_i = 4 \text{ K}$  and with unchanged temperature efficiency of 178 % the acceptable temperature difference is  $t_u - t_i = 7,1 \text{ K}$ .

To remove the thermal load of 2900 W the air flow must be changed to:

$$q = \frac{2900 \text{ W}}{7,1 \text{ K} \times 1,2 \text{ kg/m}^3 \times 1007 \text{ J/kg/K}} \times 1000 \text{ l/m}^3 = 337 \text{ l/s}$$

- 1
- 2
- 3
- 4
- 5
- 6
- 7
- 8
- 9
- 10
- 11
- 12
- 13
- 14
- 15
- 16
- 17
- 18