













Fastening material



Content – Fastening material

1	Rectangular joint system 	RJBC..... 3
2	Hex head bolt 	M6S..... 3 M6SF..... 3
3	Hex nut 	M6M..... 4 M6M..... 4
4	Circular plain washer 	BRB..... 5
5	Serrated washer 	AZ..... 5
6	Through bolt anchor 	K11..... 6
7	Drop in anchor 	K41..... 6
8	Steel screw with sharp tip 	U51, U52, U55 7
9	Steel screw with reduced drill tip 	U41, U42 7

Sealants 	MASTIC 8
Sealants 	FIRECRYL 8
Ceramic gasket 	QFPDB 9

Fastening materials



Flange profile fasteners

Rectangular Joint Bolt Clamp.

The clamp is easy to use where there is sufficient space to fasten the clamp.

Code	Material	Thickness
RJBC	GALV	3
RJBC	4404	3

Ordering example

	RJBC	GALV	3
Product			
Material			
Thickness			



Hex head bolt

Surface finish: Electro zink plated.

Code	Dim	Length mm
M6S	M8	25
M6S	M8	35
M6S	M10	30

Ordering example

	M6S	8	25
Product			
Dimension			
Length			



Hex head bolt with flange

Surface finish: Electro zink plated.

Code	Dim	Length mm
M6SF	M8	30
M6SF	M10	25

Ordering example

	M6SF	8	30
Product			
Dimension			
Length			

Fastening materials

- 1
- 2
- 3
- 4
- 5
- 6
- 7
- 8
- 9
- 10
- 11
- 12
- 13
- 14
- 15
- 16
- 17
- 18



Hex nut

Surface finish: Electro zink plated.

Code	Dim
M6M	M8
M6M	M10
M6M	M12

Ordering example

Product	M6M	8
Dimension		



Hex nut with flange

Surface finish: Electro zink plated.

Code	Dim
M6MF	M8
M6MF	M10

Ordering example

Product	M6MF	8
Dimension		

Fastening materials



Circular plain washer

Surface finish: Electro zink plated.

Code	Ø d ₁ mm	Ø d ₂ mm	t mm
BRB	6,4	12	1,5
BRB	8,4	16	1,5
BRB	10,5	22	2
BRB	13	24	2

Ordering example

Product	BRB	105	22	2
Dimension Ø d ₁				
Dimension Ø d ₂				
Thickness t				

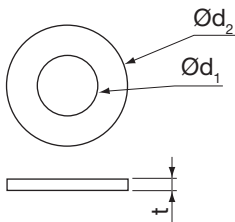

Circular serrated washer

Code	Ø d ₁ mm	Ø d ₂ mm
AZ	8,4	15,0

Ordering example

Product	AZ	84	15
Dimension Ø d ₁			
Dimension Ø d ₂			

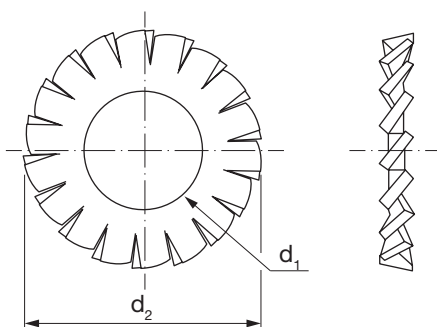

Joining materials

1

2

3

4

5

6

7

8

9

10

11

12

13

14

15

16

17

18



Through bolt anchor

Through bolt is designed for medium heavy and heavy fixings in concrete and natural stone.

Surface finish: Electro zink plated.

Code	Dim	Length mm
K11	M8	50
K11	M8	75
K11	M10	90

Ordering example

	K11	8	75
Product			
Dimension			
Length			



Drop in anchor

Drop anchor is designed for medium heavy and heavy loads. With internal thread.

Surface finish: Electro zink plated.

Code	Dim	Length mm
K41	M8	30
K41	M10	40
K41	M12	50

Ordering example

	K41	10	30
Product			
Dimension			
Length			

Joining materials



Steel screw with sharp tip

For assembling of ventilation ducts and thin sheets.

For applications where high airtightness is required.

Head: Hexagon 1/4" + Robertson R2.

Surface finish: Electro zink plated.

Code	Dim mm	Length mm	Sheet t capacity # x mm
U51	4,2	9,5	2 x 0,9
U52	4,2	13	2 x 0,9
U55	4,2	25	2 x 0,9

Ordering example

	U51	4,2	9,5
Product			
Dimension			
Length			



Steel screw with reduced drill tip

For assembling of ventilation ducts and thin sheets.

For applications where high airtightness is required.

Head: Hexagon 1/4" + Robertson R2.

Surface finish: Electro zink plated.

Code	Dim mm	Length mm	Sheet t capacity # x mm
U41	4,2	9,5	2 x 1,0
U42	4,2	13	2 x 1,0

Ordering example

	U41	4,2	9,5
Product			
Dimension			
Length			

Joining materials

1

2

3

4

5

6

7

8



MASTIC

Dim	Material	Color	Information text
300	ACRL	GREY	Phthalate free water based acrylic
5000	ACRL	GREY	Water based acrylic
300	ACRL	WHITE	Phthalate free water based acrylic
300	BUTW	GREY	Oil based plastic sealant
300	BUTS	GREY	Oil based plastic elastic sytoseal
300	SILI	GREY	Neutral curing silicone sealant.
300	SILI	TRSP	Neutral curing silicone sealant. Transparant

Ordering example

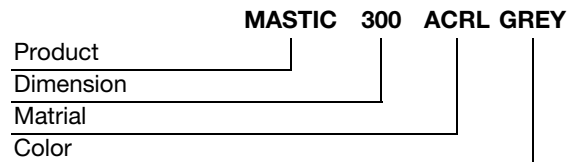

9

10

11

12

13

14

15

16

17

18



FIRECRYL

Dim	Color	Material
310	White	Intumecent acrylic for smoke control system
600	White	Intumecent acrylic for smoke control system

Ordering example

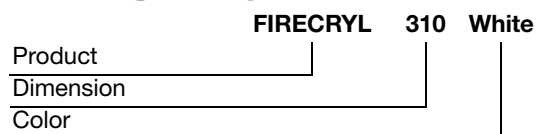

Joining materials



QFPDB

The ceramic gasket is intended to be used in a rectangular smoke control system, single compartment. The gasket shall be used in each joining.

It is adhesive on one side so it easily can be attached on the joining profile.

The size of the gasket is 25x3 mm in rolls of 10 m.

Ordering example

	QFPDB	25x3
Product		
Dimension		

- 1
- 2
- 3
- 4
- 5
- 6
- 7
- 8
- 9
- 10
- 11
- 12
- 13
- 14
- 15
- 16
- 17
- 18