



# Lindab **Ventilation**

## **Aluminum-zinc Duct System**

Technical information

# Duct system of aluminum-zinc AZ 185

## A corrosion-resistant duct system for high environmental requirements

### Products

The purpose of this brochure is to present which of Lindab's duct system products that is available in the aluminum-zinc coated steel sheet material. More detailed technical information about the system and the products can be found in our brochure "General Information and Theory" or the product's website. Aluminum-zinc products are usually handmade instead of pressed and can therefore differ from the standard galvanized assortment in size and weight.

### The circular duct system

The circular system is part of the Lindab Safe range and is manufactured as standard with a double lipped gasket made of EPDM rubber. The standard dimensions are adapted to EN 1506, which is made with over bent edge, which provides excellent structural stability and increased durability against damage caused by handling. For chemical environments other than EPDM gasket can withstand, see also how our silicone gasket is performing in the brochure "General Information and Theory". The products can also be obtained without gasket if none of our gasket options meet the requirements.

### Material description

Aluminium-zinc is a aluminium-zinc coated steel sheet that can be used unpainted up to corrosive class C4. See table on next page for information about corrosive classes.

The alloy of the metal coat has a weight percentage of 55% aluminium, 43.4% zinc and approx. 1.6 % silica with a coat weight of 185 g/m<sup>2</sup> per double side.

The surface has been treated with SPT (Surface Protection Treatment) to prevent stains during handling and to ease shaping.

### Appearance

The surface is initially glossy metal with a rose pattern but after some time it turns greyish, and eventually it becomes matt grey.

### Sheet steel properties

Aluminium-zinc coated steel sheet AZ185	According to EN 10327:2004
Fire Resistance Classification	A1 (EN 13501-1)

### Lifetime

The layer of aluminium-zinc has a thickness of approx. 25 µm (0.025 mm) per side for AZ185. The corrosive speed, i.e. how much of the coating that disappears each year, is a maximum of 0.2 µm in a normal environment (C2) in which aluminium-zinc is freely exposed.

In theory, it could therefore be evaluated that the lifetime in a normal environment exceeds 100 years. In tough marine environments, the corrosive speed can be up to 0.6 µm per year.

Due to corrosive and appearance related reasons, the following combinations should be avoided to prevent them from affecting the aesthetic and technical lifetime:

- Aluminium-zinc in combination with copper, brass or lead can cause galvanic corrosion. Avoid drainage from constructions and roofs that contain these metals. In particularly aggressive environments, even stainless steel and nickel can increase the corrosive speed of aluminium-zinc.
- Aluminium-zinc in contact with highgrade woods, damp wood or wood with waterproofing containing copper can cause black rust or corrosion.
- Aluminium-zinc in combination with bitumen products without a UV stabiliser.
- Aluminium-zinc in combination with wet concrete, cement and plastering that are very alkaline can cause discolouration or black rust.

### Trimming edges

Corrosion on the edges can occur in environments that are exposed to corrosion and in which the edges of the sheet are exposed. Normally, the trimmed edges do not need to be painted with a protective paint. Protective paint can be applied in environments in which the trimmed edges are aesthetically prominent.

## Corrosion

Aluminium-zinc has an ability to repair itself which makes the material resistant to corrosion caused by scratches. The long lifetime is due to the fact that the aluminium-zinc coating provides the steel sheet with a double protection against corrosion. The first protection factor is the coating on the steel sheet that forms a passivating barrier against general corrosion. The other protection factor involves the formation of a galvanic element when the sheet is exposed to moisture (electrolyte), resulting in zinc ions flowing over and protecting the exposed steel against corrosion in scratches or trimmed edges.

## Corrosive Class

Aluminium-zinc can be used up to corrosive class C4 in accordance with EN ISO 12944-2.

## Environment

The long lifetime of aluminium-zinc, in comparison with for instance hot dip galvanised sheets, entails major environmental benefits. There is a worldwide infrastructure for recycling steel that works well. Once steel is produced, it is part of a constant cycle as steel always contains recycled materials. Steel is always 100% recyclable, the metal layer does not pose any problems for remelting.

## Eurovent certification

Lindab’s circular duct system with rubber gasket connections Lindab Safe and Lindab Safe Click is certified to strength and leakage in tightness class D according to the Eurovent Certified Performance program for circular metallic ducts systems (DUCT-MC). Check ongoing validity of certificate:

[www.eurovent-certification.com](http://www.eurovent-certification.com)



The purpose of Eurovent third party Certification is to create a common set of criteria to all relevant features for the rating of products in this system and ensure the constancy of performance over time.

Through specification of products in Lindab’s certified system, Lindab Safe and Lindab Safe Click, the engineer’s tasks become easier, since there is no need to carry out detailed comparison and performance qualification testing. Consultants, specifiers and users can select products with the assurance that the catalogue data are accurate to a certain level.

Lindab products that are Eurovent certified have the Eurovent logotype in the footer of the technical documentation.

Note: Most Lindab Safe and Lindab Safe Click and the most commonly used product in a ventilation system are essentially better than class D, however some products are according to EN 15727 not class D as a single product. These products are stated in the documentation as Class C and can be used in D class systems to a limited extension.

## Corrosivity classes according to ISO 12944-2 with environmental examples

Corrosivity category	Corrosivity	Examples of typical environments (informative only)	
		Exterior	Interior
C1	Very low	-	Heated buildings with clean atmosphere, e.g. offices, shops, schools, hotels.
C2	Low	Atmospheres with low level of pollution: mostly rural areas.	Unheated buildings where condensation can occur, e.g. depots, sports halls.
C3	Medium	Urban and industrial atmospheres, moderate sulfur dioxide pollution; coastal areas with low salinity.	Production rooms with high humidity and some air pollution, e.g. food-processing plants, laundries, breweries, dairies.
C4	High	Industrial areas and coastal areas with moderate salinity.	Chemical plants, swimming pools, coastal ship and boatyards.
C5	Very high	Industrial areas with high humidity and aggressive atmosphere and coastal areas with high salinity.	Buildings or areas with almost permanent condensation and with high pollution.
CX	Extreme	Offshore areas with high salinity and industrial areas with extreme humidity and aggressive atmosphere and subtropical and tropical atmospheres.	Industrial areas with extreme humidity and aggressive atmosphere.

# Circular duct system

## SR, circular duct

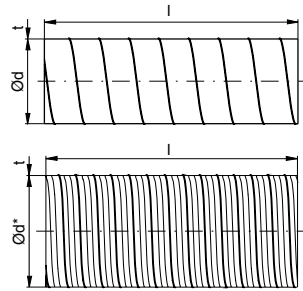

Ød nom	t mm	m kg/m	Comment
80	0,5	1,01	
100	0,5	1,27	
112	0,5	1,42	
125	0,5	1,57	
140	0,5	1,76	
150	0,5	1,89	
160	0,5	2,02	
180	0,5	2,26	
200	0,5	2,56	
224	0,5	3,42	
250	0,5	3,18	
280	0,6	4,28	For more detailed information about technical data and measures see catalogue page for SR
300	0,6	4,58	
315	0,6	4,81	
355	0,6	5,41	
400	0,6	6,56	
450	0,7	8,60	
500	0,7	9,54	
560	0,7	12,2	
600	0,7	13,1	
630	0,7	12,0	
710	0,9	17,4	
800	0,9	19,6	
900	0,9	21,7	
1000	0,9	24,1	
1120	0,9	27,0	
1250	0,9	30,2	

# Circular duct system

## BFU 90°, lockseamed bend

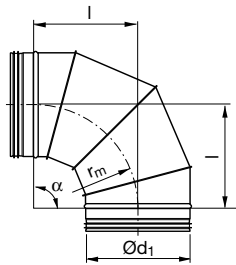

Ød, nom	l mm	m kg
80	80	0,65
140	140	1,12
150	150	1,21
180	180	1,48
200	200	1,67
224	224	1,95
250	•	•
280	•	•
300	•	•
315	•	•
355	•	•
400	•	•
450	•	•
500	•	•
560	•	•
600	•	•
630	•	•
710	•	•
800	•	•
900	•	•
1000	•	•
1120	•	•
1250	•	•

- For more detailed information about technical data and measures see catalogue page for BFU 90°

## BFU 45°, lockseamed bend

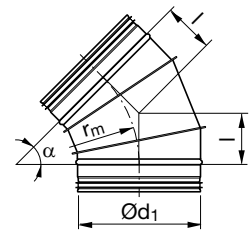

Ød, nom	l mm	m kg
80	33	0,53
140	58	0,61
150	62	0,67
180	75	0,84
200	83	0,95
224	93	1,12
250	•	•
280	•	•
300	•	•
315	•	•
355	•	•
400	•	•
450	•	•
500	•	•
560	•	•
600	•	•
630	•	•
710	•	•
800	•	•
900	•	•
1000	•	•
1120	•	•
1250	•	•

- For more detailed information about technical data and measures see catalogue page for BFU 45°

# Circular duct system

## BFU 60°, lockseamed bend

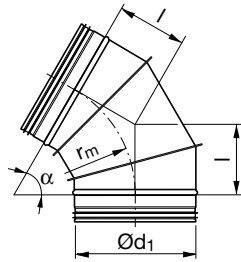

## BFU 30°, lockseamed bend

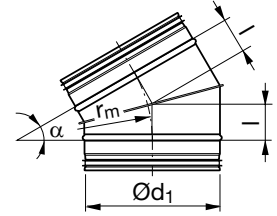

Ød, nom	l mm	m kg
80	46	0,59
100	58	0,68
125	72	0,77
140	81	0,86
150	87	0,94
180	92	1,05
160	104	1,16
200	115	1,31
224	129	1,40
250	•	•
280	•	•
300	•	•
315	•	•
355	•	•
400	•	•
450	•	•
500	•	•
560	•	•
600	•	•
630	•	•
710	•	•
800	•	•
900	•	•
1000	•	•
1120	•	•
1250	•	•

Ød, nom	l mm	m kg
80	21	0,49
100	27	0,53
125	34	0,59
140	38	0,67
150	40	0,75
180	43	0,80
160	48	0,85
200	54	0,91
224	60	0,95
250	•	•
280	•	•
300	•	•
315	•	•
355	•	•
400	•	•
450	•	•
500	•	•
560	•	•
600	•	•
630	•	•
710	•	•
800	•	•
900	•	•
1000	•	•
1120	•	•
1250	•	•

- For more detailed information about technical data and measures see catalogue page for BFU 60°

- For more detailed information about technical data and measures see catalogue page for BFU 30°

# Circular duct system

## BFU 15°, lockseamed bend

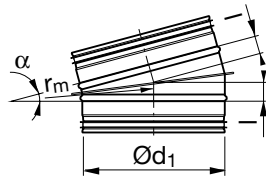

Ød, nom	l mm	m kg
80	11	0,43
100	13	0,46
125	17	0,49
140	18	0,51
150	20	0,53
180	21	0,56
160	24	0,58
200	26	0,60
224	30	0,63
250	•	•
280	•	•
300	•	•
315	•	•
355	•	•
400	•	•
450	•	•
500	•	•
560	•	•
600	•	•
630	•	•
710	•	•
800	•	•
900	•	•
1000	•	•
1120	•	•
1250	•	•

- For more detailed information about technical data and measures see catalogue page for BFU 15°



# Circular duct system

## BKFU 90°, short, lockseamed bend

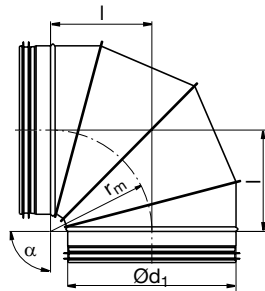

## BKFMU 90°, short, segmented bend with female end

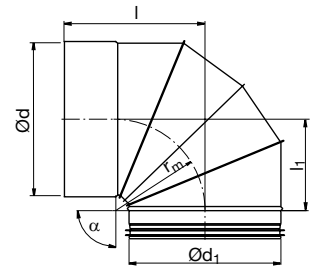

Ød, nom	Comment
100	
125	
160	
200	
250	
315	
355	
400	
500	
630	
710	
800	
1000	
1120	
1250	

For more detailed information about technical data and measures see catalogue page for BKFU 90°

Ød, nom	Comment
100	
125	
160	
200	
250	
315	
400	
500	
630	
710	
800	
1000	
1120	
1250	

For more detailed information about technical data and measures see catalogue page for BKFMU 90°



# Circular duct system

## BSFU 90°, long, lockseamed bend

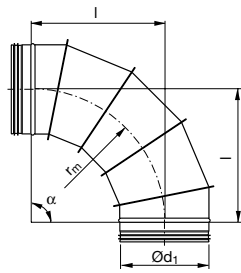

## BSFU 45°, long, lockseamed bend

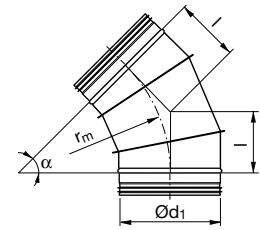

Ød, nom	Comment
250	
280	
300	
315	
355	
400	
450	
500	For more detailed information about technical data and measures see catalogue page for BSFU 90°
560	
600	
630	
710	
800	
900	
1000	
1120	
1250	

Ød, nom	Comment
250	
280	
300	
315	
355	
400	
450	
500	For more detailed information about technical data and measures see catalogue page for BSFU 45°
560	
600	
630	
710	
800	
900	
1000	
1120	
1250	

# Circular duct system

## BFKCU 90°, cleaning bend

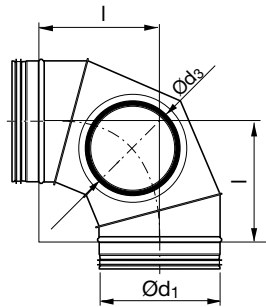

## BFBKCU 90°, cleaning bend

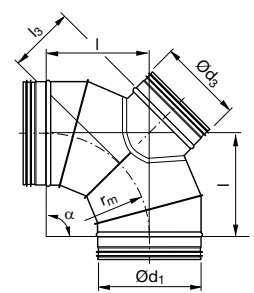

Ød <sub>1</sub> nom	Ød <sub>3</sub>						
	100	125	160	200	250	315	400
100	•						
112	•						
125	•	•					
140		•					
150		•					
160		•	•				
180			•				
200			•				
224				•			
250				•	•		
300					•		
315					•	•	
400						•	•

Ød <sub>1</sub> nom	Ød <sub>3</sub>						
	100	125	160	200	250	315	400
100	•						
112	•						
125	•	•					
140		•					
160		•	•				
150		•					
180			•				
200			•				
224				•			
250				•	•		
300					•		
315					•	•	
400						•	•

**Comment:** For more detailed information about technical data and measures see catalogue page for BFKCU 90°

- Available dimensions

**Comment:** For more detailed information about technical data and measures see catalogue page for BFBKCU 90°

- Available dimensions

# Circular duct system

## RCU, reducer

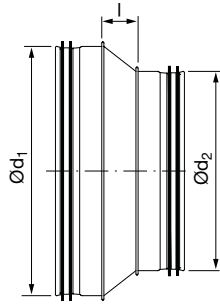

Ød <sub>1</sub> nom	Ød <sub>2</sub>											
	80	100	125	150	160	180	200	224	250	315	400	500
100	•											
125	•	•										
150		•	•									
160	•	•	•	•								
180		•	•	•	•							
200		•	•	•	•	•						
224				•	•	•	•					
250			•	•	•	•	•	•				
300							•		•			
315					•		•		•			
355									•	•		
400							•		•	•		
500									•	•	•	
630										•	•	•

**Comment:** For more detailed information about technical data and measures see catalogue page for RCU

- Available dimensions

# Circular duct system

## RCFU, reducer with female end

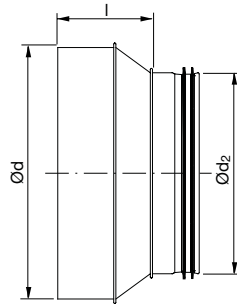

Ød nom	80	100	125	150	160	180	200	224	250	315	400	500
	100	•										
125	•	•										
150		•	•									
160		•	•	•								
180		•	•	•	•							
200		•	•	•	•	•						
224				•	•	•	•					
250			•	•	•	•	•	•				
300							•		•			
315					•		•		•			
355									•	•		
400							•		•	•		
500									•	•	•	
630										•	•	•

**Comment:** For more detailed information about technical data and measures see catalogue page for RCFU

- Available dimensions

# Circular duct system

## RU, eccentric reducer

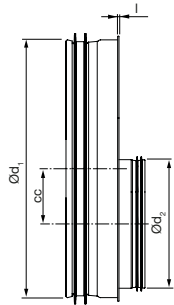

Ød <sub>1</sub> nom	Ød <sub>2</sub>																	
	200	224	250	280	300	315	355	400	450	500	560	600	630	710	800	900	1000	1120
400	•	•	•	•	•	•	•											
450			•	•	•	•	•	•										
500			•	•	•	•	•	•	•									
560						•	•	•	•	•								
600								•	•	•								
630						•	•	•	•	•	•							
710								•	•	•	•	•						
800								•	•	•	•	•	•	•				
900										•	•	•	•	•	•			
1000										•	•	•	•	•	•	•		
1120													•	•	•	•	•	
1250													•	•	•	•	•	•

**Comment:** For more detailed information about technical data and measures see catalogue page for RU

- Available dimensions

# Circular duct system

## RFU, eccentric reducer with female end

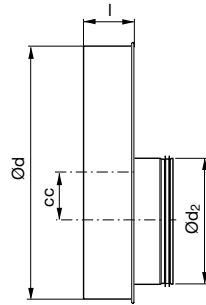

Ød nom	Ød <sub>2</sub>																	
	200	224	250	280	300	315	355	400	450	500	560	600	630	710	800	900	1000	1120
400	•	•	•	•	•	•	•											
450			•	•	•	•	•	•										
500			•	•	•	•	•	•	•									
560						•	•	•	•	•								
600						•	•	•	•	•	•							
630						•	•	•	•	•	•	•						
710								•	•	•	•	•	•					
800								•	•	•	•	•	•	•				
900										•	•	•	•	•	•			
1000										•	•	•	•	•	•	•		
1120													•	•	•	•	•	
1250													•	•	•	•	•	•

**Comment:** For more detailed information about technical data and measures see catalogue page for RFU

- Available dimensions

# Circular duct system

## RFLU, long, tangential reducer with female end

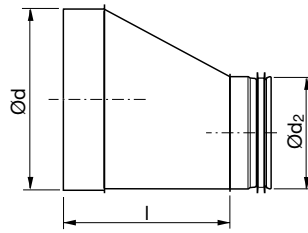

Ød nom																												
	80	100	112	125	140	150	160	180	200	224	250	280	300	315	355	400	450	500	560	600	630	710	800	900	1000	1120		
100	•																											
112	•	•																										
125	•		•																									
140	•		•	•																								
150	•	•	•	•	•																							
160	•	•	•	•	•	•																						
180	•	•	•	•	•	•	•																					
200	•	•	•	•	•	•	•	•																				
224		•	•	•	•	•	•	•	•																			
250		•	•	•	•	•	•	•	•	•																		
280				•	•	•	•	•	•	•	•																	
300				•	•	•	•	•	•	•	•	•																
315				•	•	•	•	•	•	•	•	•	•															
355							•	•	•	•	•	•	•	•														
400							•	•	•	•	•	•	•	•	•													
450									•	•	•	•	•	•	•	•												
500									•	•	•	•	•	•	•	•	•											
560											•	•	•	•	•	•	•	•										
600											•	•	•	•	•	•	•	•	•									
630											•	•	•	•	•	•	•	•	•	•								
710															•	•	•	•	•	•	•	•						
800																•	•	•	•	•	•	•	•	•				
900																	•	•	•	•	•	•	•	•	•			
1000																			•	•	•	•	•	•	•	•		
1120																			•	•	•	•	•	•	•	•	•	
1250																				•	•	•	•	•	•	•	•	•

**Comment:** For more detailed information about technical data and measures see catalogue page for RFLU

- Available dimensions



# Circular duct system

## RCLU, long, concentric reducer

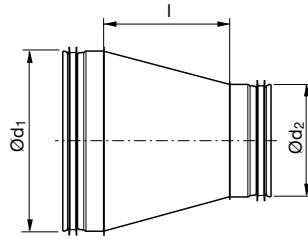

$\varnothing d_1$ nom																											
	80	100	112	125	140	150	160	180	200	224	250	280	300	315	355	400	450	500	560	600	630	710	800	900	1000	1120	
100	•																										
112	•	•																									
125			•																								
140	•	•	•	•																							
150	•		•		•																						
160			•		•																						
180	•		•		•																						
200	•		•		•																						
224		•	•	•	•																						
250		•	•		•																						
280				•	•	•	•	•	•	•	•																
300				•	•	•	•	•		•		•															
315				•	•	•		•		•		•	•														
355							•	•	•	•	•	•	•														
400							•	•		•		•	•		•												
450								•	•	•	•	•	•	•	•	•											
500									•	•	•	•	•		•	•	•										
560											•	•	•	•	•	•	•	•	•								
600											•	•	•	•	•	•	•	•	•	•							
630											•	•	•		•	•	•	•	•	•	•						
710															•	•	•	•	•	•	•	•					
800																•	•	•	•	•	•	•	•	•			
900																	•	•	•	•	•	•	•	•	•		
1000																		•	•	•	•	•	•	•	•	•	
1120																			•	•	•	•	•	•	•	•	•
1250																				•	•	•	•	•	•	•	•

**Comment:** For more detailed information about technical data and measures see catalogue page for RCLU

- Available dimensions





# Circular duct system

## RCFLU, long, concentric reducer with female end

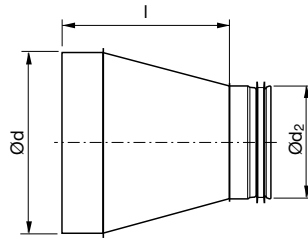

Ød nom																											
	80	100	112	125	140	150	160	180	200	224	250	280	300	315	355	400	450	500	560	600	630	710	800	900	1000	1120	
100	•																										
112	•	•																									
125	•	•	•																								
140	•	•	•	•																							
150	•	•	•	•	•																						
160	•	•	•	•	•	•																					
180	•	•	•	•	•	•	•																				
200	•	•	•	•	•	•	•	•																			
224		•	•	•	•	•	•	•	•																		
250		•	•	•	•	•	•	•	•	•																	
280				•	•	•	•	•	•	•	•																
300				•	•	•	•	•	•	•	•	•															
315				•	•	•	•	•	•	•	•	•	•														
355							•	•	•	•	•	•	•	•													
400							•	•	•	•	•	•	•	•	•												
450									•	•	•	•	•	•	•	•											
500									•	•	•	•	•	•	•	•	•										
560											•	•	•	•	•	•	•	•									
600											•	•	•	•	•	•	•	•	•								
630											•	•	•	•	•	•	•	•	•	•							
710															•	•	•	•	•	•	•	•					
800																•	•	•	•	•	•	•	•	•			
900																	•	•	•	•	•	•	•	•	•		
1000																		•	•	•	•	•	•	•	•	•	
1120																			•	•	•	•	•	•	•	•	•
1250																				•	•	•	•	•	•	•	•

**Comment:** For more detailed information about technical data and measures see catalogue page for RCFLU

- Available dimensions



# Circular duct system

## RLU, long tangential reducer

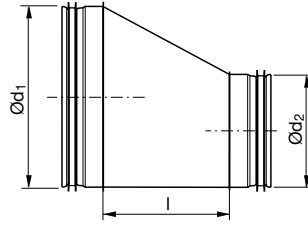

Ød <sub>1</sub> nom																											
	80	100	112	125	140	150	160	180	200	224	250	280	300	315	355	400	450	500	560	600	630	710	800	900	1000	1120	
100	•																										
112	•	•																									
125	•	•	•																								
140	•	•	•	•																							
150	•	•	•	•	•																						
160	•	•	•	•	•	•																					
180	•	•	•	•	•	•	•																				
200	•	•	•	•	•	•	•	•																			
224		•	•	•	•	•	•	•	•																		
250		•	•	•	•	•	•	•	•	•																	
280				•	•	•	•	•	•	•	•																
300				•	•	•	•	•	•	•	•	•															
315				•	•	•	•	•	•	•	•	•	•														
355						•	•	•	•	•	•	•	•	•													
400						•	•	•	•	•	•	•	•	•	•												
450								•	•	•	•	•	•	•	•	•											
500									•	•	•	•	•	•	•	•	•										
560										•	•	•	•	•	•	•	•	•									
600										•	•	•	•	•	•	•	•	•	•								
630										•	•	•	•	•	•	•	•	•	•	•							
710															•	•	•	•	•	•	•						
800																•	•	•	•	•	•	•					
900																	•	•	•	•	•	•	•				
1000																		•	•	•	•	•	•	•			
1120																			•	•	•	•	•	•	•		
1250																				•	•	•	•	•	•	•	•

**Comment:** For more detailed information about technical data and measures see catalogue page for RLU

- Available dimensions



# Circular duct system

## TCU, centric T-piece

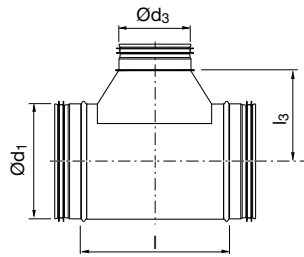

Ød <sub>1</sub> nom																											
	80	100	112	125	140	150	160	180	200	224	250	280	300	315	355	400	450	500	560	600	630	710	800	900	1000	1120	1250
80	•*		•	•																							
100	•*	•*	•	•	•	•	•																				
112	•*	•*	•		•	•	•	•																			
125	•*	•*	•*	•*	•	•	•	•	•																		
140	•*	•*	•*	•	•*	•	•	•	•	•																	
150	•*	•*	•	•*	•*	•*		•	•	•	•																
160	•*	•*		•*	•*	•*	•*		•	•	•	•															
180	•*	•*	•	•*	•*	•*	•*	•*	•	•	•	•	•														
200	•*	•*	•	•*	•*	•*	•*	•*	•*	•	•	•	•	•													
224	•*	•*	•	•*	•*	•*	•*	•*	•*	•*	•	•	•	•	•												
250	•*	•*	•	•*	•*	•*	•*	•*	•*	•*	•*	•	•	•	•	•											
280	•*	•*	•	•*	•*	•*	•*	•*	•*	•*	•	•	•	•	•	•	•										
300			•								•	•	•	•	•	•	•	•									
315	•*	•*	•	•*			•*		•*		•*		•*	•	•	•	•	•	•								
355			•								•	•	•	•	•	•	•	•	•	•							
400		•*	•	•*	•	•	•*	•	•*		•*	•	•	•	•	•*	•	•	•	•	•	•					
450		•*		•*	•	•	•*	•	•*	•*	•*	•	•*	•*	•*	•*	•	•	•	•	•	•	•				
500		•*		•*	•	•	•*	•	•*	•	•*	•	•*	•*	•*	•*	•	•	•	•	•	•	•	•			
560		•*		•*			•*		•*	•	•*	•	•*	•*	•*	•*	•	•	•	•	•	•	•	•	•		
600		•*		•*			•*		•*	•	•*	•	•	•	•	•*	•	•	•	•	•	•	•	•	•		
630		•*		•*			•*		•*	•	•*	•	•	•	•*	•	•	•	•	•	•	•	•	•	•	•	
710											•	•	•	•	•	•	•	•	•	•	•	•	•	•	•	•	
800											•	•	•	•	•	•	•	•	•	•	•	•	•	•	•	•	•
900																											
1000																											
1120																											
1250																											

**Comment:** For more detailed information about technical data and measures see catalogue page for TCU

- Available dimensions
- \* Only available in aluminum-zinc. When made in galvanized this dimension is pressed, see TCPU



# Circular duct system

## TU, tangential T-piece

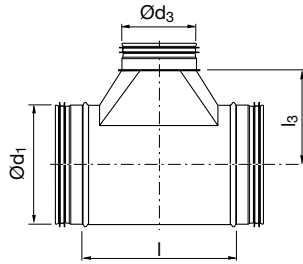

$\varnothing d_1$ nom																											
	80	100	112	125	140	150	160	180	200	224	250	280	300	315	355	400	450	500	560	600	630	710	800	900	1000	1120	1250
80	•	•	•	•																							
100	•	•	•	•	•	•	•																				
112	•	•	•	•	•	•	•	•																			
125	•	•	•	•	•	•	•	•	•																		
140	•	•	•	•	•	•	•	•	•	•																	
150	•	•	•	•	•	•	•	•	•	•	•																
160	•	•	•	•	•	•	•	•	•	•	•	•															
180	•	•	•	•	•	•	•	•	•	•	•	•	•														
200	•	•	•	•	•	•	•	•	•	•	•	•	•	•													
224	•	•	•	•	•	•	•	•	•	•	•	•	•	•	•												
250	•	•	•	•	•	•	•	•	•	•	•	•	•	•	•	•											
280	•	•	•	•	•	•	•	•	•	•	•	•	•	•	•	•	•										
300	•	•	•	•	•	•	•	•	•	•	•	•	•	•	•	•	•										
315	•	•	•	•	•	•	•	•	•	•	•	•	•	•	•	•	•	•									
355		•	•	•	•	•	•	•	•	•	•	•	•	•	•	•	•	•	•								
400		•	•	•	•	•	•	•	•	•	•	•	•	•	•	•	•	•	•	•							
450				•	•	•	•	•	•	•	•	•	•	•	•	•	•	•	•	•	•						
500				•	•	•	•	•	•	•	•	•	•	•	•	•	•	•	•	•	•	•					
560									•	•	•	•	•	•	•	•	•	•	•	•	•	•	•				
600									•	•	•	•	•	•	•	•	•	•	•	•	•	•	•	•			
630									•	•	•	•	•	•	•	•	•	•	•	•	•	•	•	•	•		
710																											
800																											
900																											
1000																											
1120																											
1250																											

**Comment:** For more detailed information about technical data and measures see catalogue page for TU

- Available dimensions



# Circular duct system

## TSTCU, centric T-piece

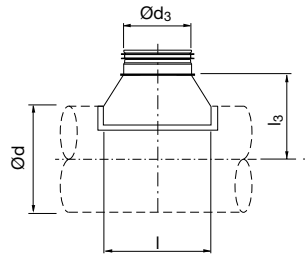

Ød nom																											
	80	100	112	125	140	150	160	180	200	224	250	280	300	315	355	400	450	500	560	600	630	710	800	900	1000	1120	1250
80	•*	•	•	•																							
100	•*	•*	•	•	•	•	•																				
112			•	•	•	•	•	•																			
125	•*	•*	•	•*	•	•	•	•	•																		
140	•		•			•	•	•	•	•																	
150	•		•				•	•	•	•	•																
160	•*	•*	•	•*			•*	•	•	•	•																
180	•		•	•	•	•	•		•	•	•	•															
200	•*	•*	•	•*			•*	•	•*	•	•	•	•	•													
224			•							•	•	•	•	•	•												
250		•*	•	•*			•*	•	•*	•	•*	•	•	•	•	•											
280			•							•	•	•	•	•	•	•	•										
300			•							•	•	•	•	•	•	•	•										
315	•*	•*	•	•*			•*	•	•*	•	•*	•	•	•*	•	•	•	•	•								
355			•									•	•	•	•	•	•	•	•	•							
400		•*	•	•*	•		•*	•	•*	•	•*	•	•	•*	•	•*	•	•	•	•	•	•					
450					•			•			•	•	•	•	•	•	•	•	•	•	•	•	•				
500					•			•				•	•	•	•	•	•	•	•	•	•	•	•	•			
560												•	•	•	•	•	•	•	•	•	•	•	•	•	•		
600												•	•	•	•	•	•	•	•	•	•	•	•	•	•		
630												•	•	•	•	•	•	•	•	•	•	•	•	•	•	•	
710										•	•	•	•	•	•	•	•	•	•	•	•	•	•	•	•	•	•
800										•	•	•	•	•	•	•	•	•	•	•	•	•	•	•	•	•	•
900												•	•	•	•	•	•	•	•	•	•	•	•	•	•	•	•
1000														•	•	•	•	•	•	•	•	•	•	•	•	•	•
1120																			•	•	•	•	•	•	•	•	•
1250																			•	•	•	•	•	•	•	•	•

**Comment:** For more detailed information about technical data and measures see catalogue page for TSTCU

- Available dimensions
- \* Only available in . When made in galvanized this dimension is pressed, see TCPU



# Circular duct system

## TSTU, tangential T-piece

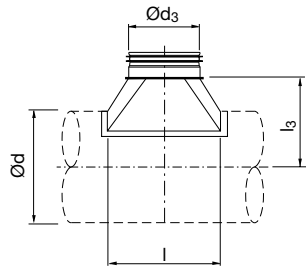

Ød nom																											
	80	100	112	125	140	150	160	180	200	224	250	280	300	315	355	400	450	500	560	600	630	710	800	900	1000	1120	1250
80		•	•	•																							
100	•		•	•	•	•	•																				
112	•	•		•	•	•	•	•																			
125	•	•	•		•	•	•	•	•																		
140	•	•	•	•		•	•	•	•	•																	
150	•	•	•	•	•		•	•	•	•	•																
160	•	•	•	•	•	•		•	•	•	•																
180	•	•	•	•	•	•	•		•	•	•	•															
200	•	•	•	•	•	•	•	•		•	•	•	•														
224	•	•	•	•	•	•	•	•	•		•	•	•	•													
250	•	•	•	•	•	•	•	•	•	•		•	•	•	•												
280	•	•	•	•	•	•	•	•	•	•	•		•	•	•	•											
300	•	•	•	•	•	•	•	•	•	•	•	•		•	•	•	•										
315	•	•	•	•	•	•	•	•	•	•	•	•	•		•	•	•	•									
355		•	•	•	•	•	•	•	•	•	•	•	•	•		•	•	•	•								
400		•	•	•	•	•	•	•	•	•	•	•	•	•	•		•	•	•	•							
450				•	•	•	•	•	•	•	•	•	•	•	•	•		•	•	•	•		•				
500				•	•	•	•	•	•	•	•	•	•	•	•	•	•		•	•	•	•	•	•			
560										•	•	•	•	•	•	•	•	•		•	•	•	•	•	•		
600										•	•	•	•	•	•	•	•	•	•		•	•	•	•	•		
630										•	•	•	•	•	•	•	•	•	•	•		•	•	•	•	•	
710											•	•	•	•	•	•	•	•	•	•		•	•	•	•	•	
800											•	•	•	•	•	•	•	•	•	•	•		•	•	•	•	•
900												•	•	•	•	•	•	•	•	•	•		•	•	•	•	•
1000													•	•	•	•	•	•	•	•	•		•	•	•	•	•
1120																			•	•	•	•	•	•	•	•	•
1250																			•	•	•	•	•	•	•	•	•

**Comment:** For more detailed information about technical data and measures see catalogue page for TSTU.

- Available dimensions



# Circular duct system

## XCU, centric X-piece

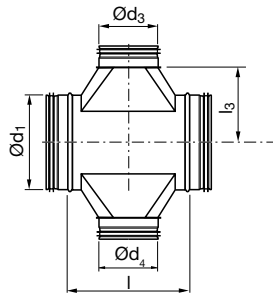

$\varnothing d_1$ nom																												
	80	100	112	125	140	150	160	180	200	224	250	280	300	315	355	400	450	500	560	600	630	710	800	900	1000	1120	1250	
80	•																											
100	•	•																										
112	•	•	•																									
125	•	•	•	•																								
140	•	•	•	•	•																							
150	•	•	•	•	•	•																						
160	•	•	•	•	•	•	•																					
180	•	•	•	•	•	•	•	•																				
200	•	•	•	•	•	•	•	•	•																			
224	•	•	•	•	•	•	•	•	•	•																		
250	•	•	•	•	•	•	•	•	•	•	•																	
280	•	•	•	•	•	•	•	•	•	•	•	•																
300	•	•	•	•	•	•	•	•	•	•	•	•	•															
315	•	•	•	•	•	•	•	•	•	•	•	•	•	•														
355		•	•	•	•	•	•	•	•	•	•	•	•	•	•													
400		•	•	•	•	•	•	•	•	•	•	•	•	•	•	•												
450				•	•	•	•	•	•	•	•	•	•	•	•	•	•											
500				•	•	•	•	•	•	•	•	•	•	•	•	•	•	•										
560									•	•	•	•	•	•	•	•	•	•	•									
600									•	•	•	•	•	•	•	•	•	•	•	•								
630									•	•	•	•	•	•	•	•	•	•	•	•	•							
710												•	•	•	•	•	•	•	•	•	•	•						
800											•	•	•	•	•	•	•	•	•	•	•	•	•					
900														•	•	•	•	•	•	•	•	•	•	•				
1000														•	•	•	•	•	•	•	•	•	•	•	•			
1120																										•	•	
1250																											•	•

**Comment:** For more detailed information about technical data and measures see catalogue page for XCU.

- Available dimensions



# Circular duct system

## XU, tangential X-piece

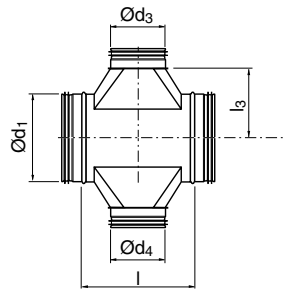

Ød <sub>1</sub> nom																											
	80	100	112	125	140	150	160	180	200	224	250	280	300	315	355	400	450	500	560	600	630	710	800	900	1000	1120	
80																											
100	•																										
112	•	•																									
125	•	•	•																								
140	•	•	•	•																							
150	•	•	•	•	•																						
160	•	•	•	•	•	•																					
180	•	•	•	•	•	•	•																				
200	•	•	•	•	•	•	•	•																			
224	•	•	•	•	•	•	•	•	•																		
250	•	•	•	•	•	•	•	•	•	•																	
280	•	•	•	•	•	•	•	•	•	•	•																
300	•	•	•	•	•	•	•	•	•	•	•	•															
315	•	•	•	•	•	•	•	•	•	•	•	•	•														
355		•	•	•	•	•	•	•	•	•	•	•	•	•													
400		•	•	•	•	•	•	•	•	•	•	•	•	•	•												
450				•	•	•	•	•	•	•	•	•	•	•	•	•											
500				•	•	•	•	•	•	•	•	•	•	•	•	•	•										
560									•	•	•	•	•	•	•	•	•	•									
600									•	•	•	•	•	•	•	•	•	•	•								
630									•	•	•	•	•	•	•	•	•	•	•	•							
710											•	•	•	•	•	•	•	•	•	•	•						
800										•	•	•	•	•	•	•	•	•	•	•	•	•					
900														•	•	•	•	•	•	•	•	•	•				
1000															•	•	•	•	•	•	•	•	•	•			
1120																			•	•	•	•	•	•	•	•	•
1250																			•	•	•	•	•	•	•	•	•

**Comment:** For more detailed information about technical data and measures see catalogue page for XU.

- Available dimensions





# Circular duct system

## ILU, take-off without radius

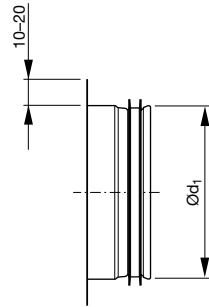

## ILF, take-off without radius with female end

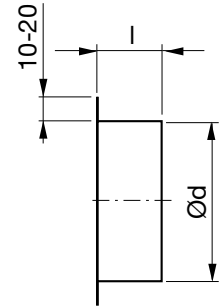

Ød, nom	Comment
80	
100	
112	
125	
140	
150	
160	
180	
200	
224	
250	
280	
300	For more detailed information about technical data and measures see catalogue page for ILU.
315	
355	
400	
450	
500	
560	
600	
630	
710	
800	
900	
1000	
1120	
1250	

Ød nom	Comment
80	
100	
112	
125	
140	
150	
160	
180	
200	
224	
250	
280	
300	For more detailed information about technical data and measures see catalogue page for ILF.
315	
355	
400	
450	
500	
560	
600	
630	
710	
800	
900	
1000	
1120	
1250	

# Circular duct system

## ESNU, take-off with mesh

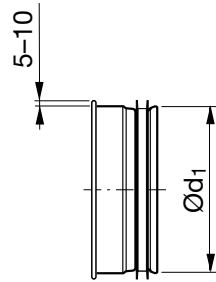

## EPNF, take-off with mesh and female end

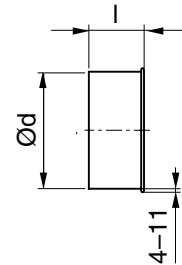

Ød, nom	Comment
80	
100	
112	
125	
140	
150	
160	
180	
200	
224	
250	
280	
300	For more detailed information about technical data and measures see catalogue page for ESNU.
315	
355	
400	
450	
500	
560	
600	
630	
710	
800	
900	
1000	
1120	
1250	

Ød nom	Comment
80	
100	
112	
125	
140	
150	
160	
180	
200	
224	
250	
280	
300	For more detailed information about technical data and measures see catalogue page for EPNF.
315	
355	
400	
450	
500	
560	
600	
630	
710	
800	
900	
1000	
1120	
1250	

# Circular duct system

**ILKNU 50, take-off with mesh and cone**

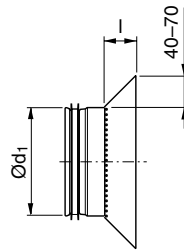

**ILKNU 100, take-off with mesh and cone**

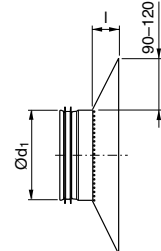

$\varnothing d, \text{nom}$	Comment
80	For more detailed information about technical data and measures see catalogue page for ILKNU 50.
100	
125	
160	
200	
250	
315	
400	
500	
630	
800	

$\varnothing d, \text{nom}$	Comment
80	For more detailed information about technical data and measures see catalogue page for ILKNU 100.
100	
125	
160	
200	
250	
315	
400	
500	
630	
800	

**ILKNF 50, take-off with mesh, cone and female end**

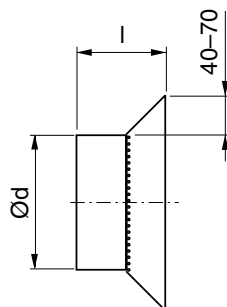

**ILKNF 100, take-off with mesh, cone and female end**

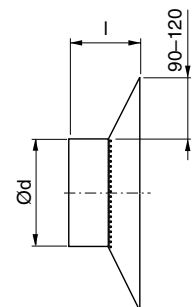

$\varnothing d, \text{nom}$	Comment
100	For more detailed information about technical data and measures see catalogue page for ILKNF 50.
125	
160	
200	
250	
315	
400	
500	
630	
800	

$\varnothing d, \text{nom}$	Comment
100	For more detailed information about technical data and measures see catalogue page for ILKNF 100.
125	
160	
200	
250	
315	
400	
500	
630	
800	

# Circular duct system

## NPU, coupling

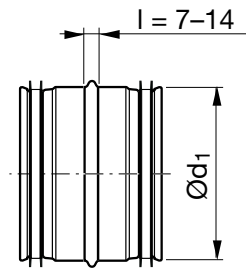

## SNPU, slide-in coupling

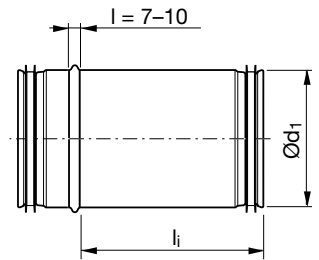

Ød, nom	Comment
80	
100	
112	
125	
140	
150	
160	
180	
200	
224	
250	
280	
300	For more detailed information about technical data and measures see catalogue page for NPU.
315	
355	
400	
450	
500	
560	
600	
630	
710	
800	
900	
1000	
1120	
1250	

Ød, nom	Comment
80	
100	
112	
125	
140	
150	
160	
180	
200	
224	All dimensions available in nominal lengths 150 mm, 300 mm and 500 mm.
250	
280	
300	
315	
355	For more detailed information about technical data and measures see catalogue page for SNPU.
400	
450	
500	
560	
630	
800	
1000	
1250	

# Circular duct system

## MF, female coupling

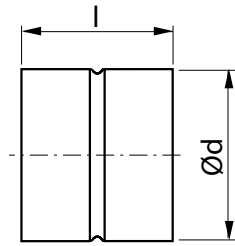

## SMFU, slide-in female coupling

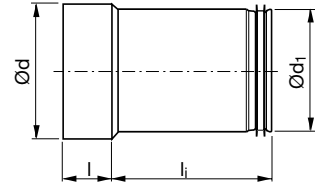

Ød nom	Comment
80	
100	
112	
125	
140	
150	
160	
180	
200	
224	
250	
280	
300	For more detailed information about technical data and measures see catalogue page for MF.
315	
355	
400	
450	
500	
560	
600	
630	
710	
800	
900	
1000	
1120	
1250	

Ød <sub>1</sub> nom	l mm	Comment	
80			
100			
112			
125			
140			
150	150, 300 or 500	For more detailed information about technical data and measures see catalogue page for SMFU.	
160			
180			
200			
224			
250			
280			
300			
315			
355			
400	300 or 500		
450			
500			
560			
630			
800	500		
1000			
1250			

# Circular duct system

## EPF, end cap

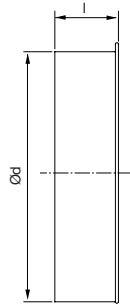

## ESU, end cap

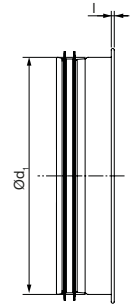

Ød nom	Comment
80	
100	
112	
125	
140	
150	
160	
180	
200	
224	
250	
280	
300	For more detailed information about technical data and measures see catalogue page for EPF.
315	
355	
400	
450	
500	
560	
600	
630	
710	
800	
900	
1000	
1120	
1250	

Ød, nom	Comment
80	
100	
112	
125	
140	
150	
160	
180	
200	
224	
250	
280	
300	For more detailed information about technical data and measures see catalogue page for ESU.
315	
355	
400	
450	
500	
560	
600	
630	
710	
800	
900	
1000	
1120	
1250	

# Circular duct system

## EPFH, access door

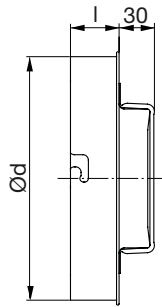

## ESHU, access door

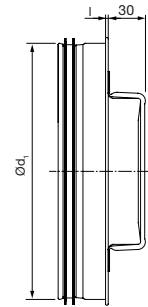

Ød nom	Comment
80	
100	
112	
125	
140	
150	
160	
180	
200	
224	
250	
280	
300	
315	
355	
400	
450	
500	
630	

For more detailed information about technical data and measures see catalogue page for EPFH.

Ød, nom	Comment
80	
100	
112	
125	
140	
150	
160	
180	
200	
224	
250	
280	
300	
315	
355	
400	
450	
500	
630	

For more detailed information about technical data and measures see catalogue page for ESHU.

# Circular duct system

## SLCU 50, circular straight silencer

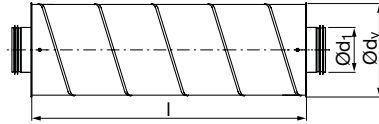

Ød <sub>1</sub> nom	l			
	300	600	900	1200
80	•	•	•	•
100	•	•	•	•
125	•	•	•	•
160	•	•	•	•
200	•	•	•	•
250		•	•	•
315		•	•	•
400		•	•	•

**Comment:** For more detailed information about technical data and measures see catalogue page for SLCU 50.

- Available lengths



# Circular duct system

## DRU, regulating damper

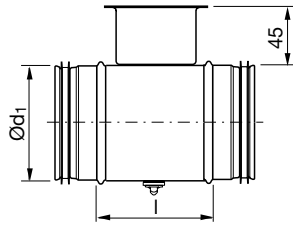

## DSU, shut-off damper

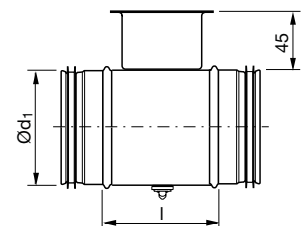

Ød, nom	Comment
80	
100	
112	
125	
140	
150	
160	
180	
200	
224	For more detailed information about technical data and measures see catalogue page for DRU.
250	
280	
300	
315	
355	
400	
450	
500	
560	
600	
630	

Ød, nom	Comment
80	
100	
112	
125	
140	
150	
160	
180	
200	
224	For more detailed information about technical data and measures see catalogue page for DSU.
250	
280	
300	
315	
355	
400	
450	
500	
560	
600	
630	

# Circular duct system

## DTU, shut-off damper

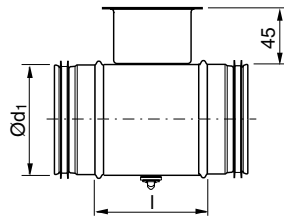

## DTHU, shut-off damper with motor shelf

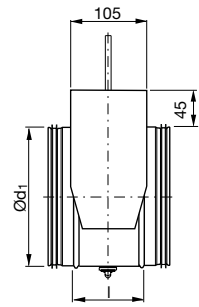

Ød, nom	Comment
80	
100	
112	
125	
140	
150	
160	
180	
200	
224	For more detailed information about technical data and measures see catalogue page for DTU.
250	
280	
300	
315	
355	
400	
450	
500	
560	
600	
630	

Ød, nom	Comment
80	
100	
112	
125	
140	
150	
160	
180	
200	
224	For more detailed information about technical data and measures see catalogue page for DTHU.
250	
280	
300	
315	
355	
400	
450	
500	
560	
600	
630	

# Duct suspension and support system

## MDH, duct holder

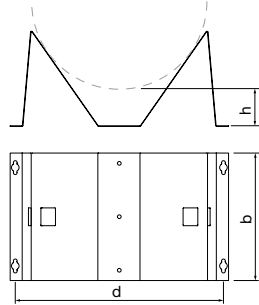

## DH, duct holder

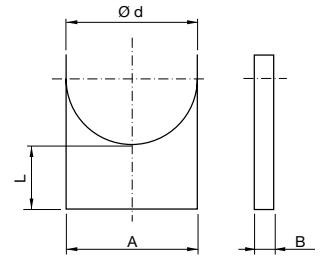

Ød nom	Comment
100	
112	
125	
140	
150	
160	
180	
200	
224	
250	For more detailed information about technical data and measures see catalogue page for MDH.
280	
300	
315	
355	
400	
450	
500	
560	
600	
630	

Ød nom	Comment
80	
100	
125	
160	For more detailed information about technical data and measures see catalogue page for DH.
200	
250	
315	
400	
500	
630	

# Duct suspension and support system

## UV30, suspension rings

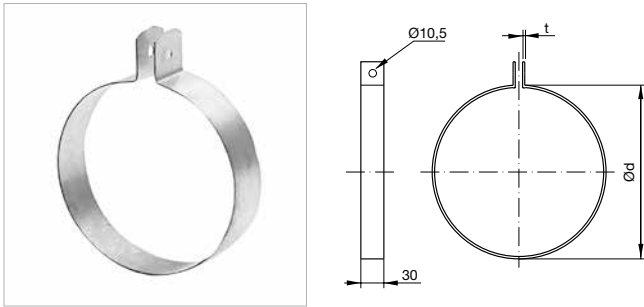

Ød nom	Comment
80	For more detailed information about technical data and measures see catalogue page for UV30.
100	
125	
160	
200	
250	
315	
400	
500	
630	

## UVH30, suspension rings

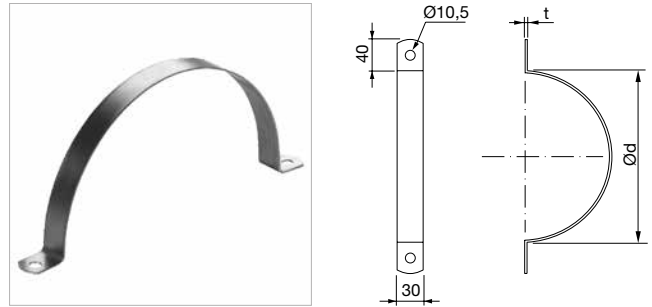

Ød nom	Comment
400	For more detailed information about technical data and measures see catalogue page for UVH30.
500	
630	
800	

# Fasteners

## Blind rivet, pressure-tight



Type	Dim	Comment
RG12	3,2×8,0	For more detailed information about technical data see technical information for RG
RG13	3,2×9,5	
RG22	4,0×9,5	
RG23	4,0×12,5	
RG32	4,8×9,5	
RG33	4,8×12,5	

## Blind rivet, open



Type	Dim	Comment
RK12	3,2×8,0	For more detailed information about technical data see technical information for RK
RK14	3,2×9,5	
RK16	3,2×11,0	
RK22	4,0×10,5	
RK24	4,0×12,5	
RK32	4,8×10,0	



## Good Thinking

**At Lindab**, good thinking is a philosophy that guides us in everything we do. We have made it our mission to create a healthy indoor climate – and to simplify the construction of sustainable buildings. We do that by designing innovative products and solutions that are easy to use, as well as offering efficient availability and logistics. We are also working on ways to reduce our impact on our environment and climate. We do that by developing methods to produce our solutions using a minimum of energy and natural resources, and by reducing negative effects on the environment. We use steel in our products. It's one of few materials that can be recycled an infinite number of times without losing any of its properties. That means less carbon emissions in nature and less energy wasted.

**We simplify construction**