

# Решетка для конвекторной ниши A1

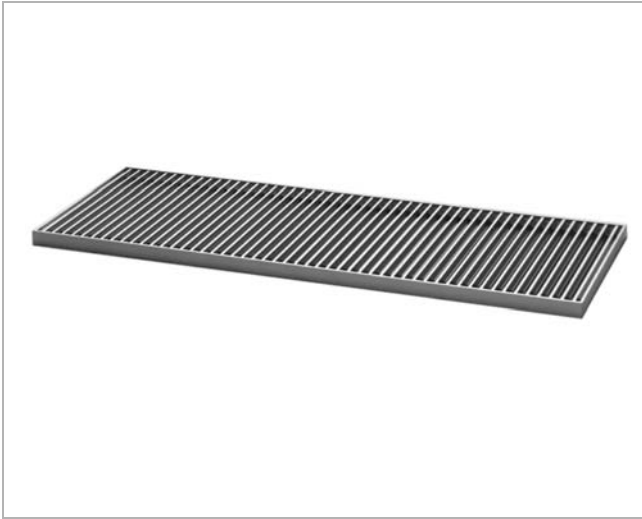

## Размеры

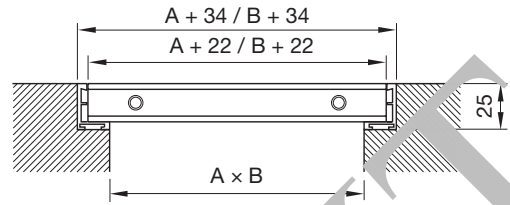

## Öäåòà:

0 - àòóðàèùíà àíæðíááíá

## Описание

A1-æþíéíèáááÿ ðáðáðèà ñ íáðááóèèðóáíùíè íèàñðèíáè, ðàçðááíòáíáÿ ñíáðèèèùíí æÿ ïáðæááíèÿ íáíèùíó èííáèðíðá. Ó ÿíé ðáðáðèè íèàñðèíá àñáááà íáðááèáíù íáðíáíèèóÿðíí æèííé ñòíðíá. Ðàññòíÿèá íáæáó íèàñðèíáè-20 ì, ìèðúòàÿ íèíúáá ðáðáðèè-75% . Ðàçíáðú ðáðáðèè ñðáááÿðòñÿ èíæèèáóáèùíí, ñ ðèíéá íá ìáááúðááò 500 ì.

## Íáñèóæèááíèá

Æÿ ì-èñðèè èáíèèà ðáðáðèà ááííòðóáóñÿ èç íèàñðèíá. Ðáðáðèà ì-èùááòñÿ ñ ñííùð æèáæíé ðíáíè

## Пример для заказа

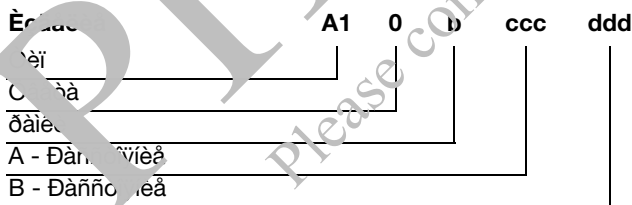

## Ñòáíáððíóé ðàçíáð A:

200 - 250 - 300 - 350 - 400 - 450 - 500

## Íñðááÿðòñÿ àí àñáò ðàçíáðáò.

Ðáðáðèè ññðááÿðòñÿ ðàçááèáííèè íá 1 ìáðíáúá ñáèóèè. Ìæñèíáèùíáÿ æèíá óáèùíé ðáíèè 3 ì. Íðè áíèùðèð ðàçíáðáò ññðááÿðòñÿ ðàèæá óçáè æÿ ñíááèíáèÿ ñáèóèè Ìæñèíáèùíè ðàçíáð A íá ìáááúðááò 500 ì. B dimension as requested

## Ìàðáðèèè è ìáááèè

Ðáðáðèà: Áèþíéé  
Ñòáíáððíáÿ ìáááèè: Áíæðíááíáÿ

Áíçíæíá íèðàñèá á äðóáèá óááòà.Íæàèóéñòà ñáÿæèðáñú ñ ááíáððáíáíòá ìðíáæ èííáíèè Lindab æÿ ñíèó-áíèÿ áíèáá ñáðíáíé èíðíðáðèè

# Решетка для конвекторной ниши A1

## Размеры

0 - Άάç ðàìèè

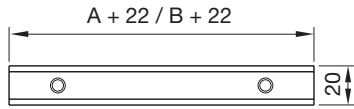

1 - Ñ óäëíàíé ðàìèé

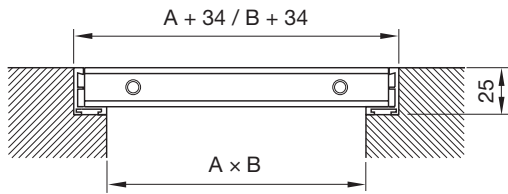

3 - Z-íáðáçáíäý ðàìèà ñ ðèáíóáì

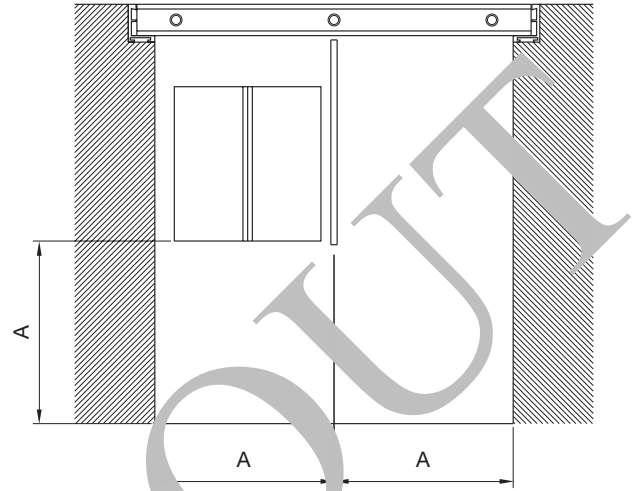
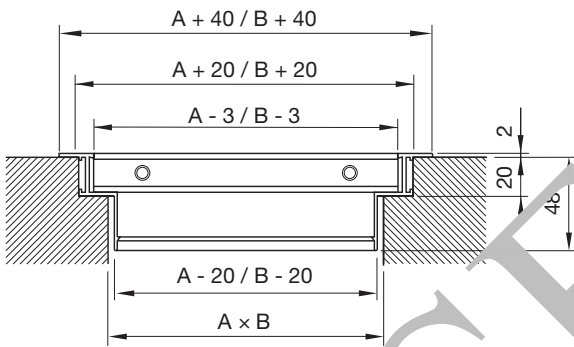

Íðíáíü äéý éíáç ððíá ðííèáíéý ðíáèèððòñý á ñíðááðñðáèè ñ èíðóççéýíè ðíèçáíáèðáèáè è áúðá ðèááç ðèñóíèí.

PHASED  
Please contact Lindab for an alternative solution