

# Bend with male and female end

# BMU 45°

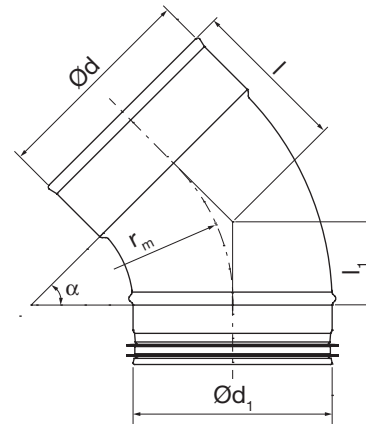

## Dimensions



## Description

Pressed and seam welded bend with one male and one female end.  
 Has Click function at the male (Safe) end – has an open turned over edge.  
 Has normally not any Click function at the female end – hasn't any notches.  
 Ø 100–200 can upon order be delivered with click function at the female end as well – i.e. with notches.

Ød <sub>1</sub> nom	Ød nom	l [mm]	l <sub>1</sub> [mm]	m kg
100	100	85	35	0,20
125	125	93	44	0,28
160	160	110	58	0,45
200	200	125	77	0,80

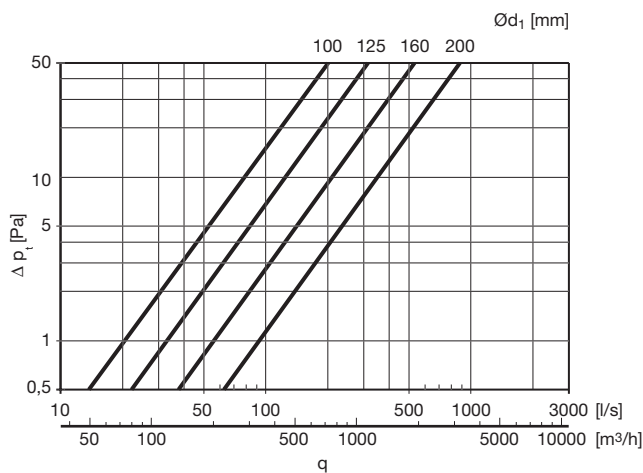

## Ordering example

