

Lähtökaulus

PSU



Tuotekuvaus

Syvävedetty lähtökaulus. Säde haaroitusta kohden.

Mitat

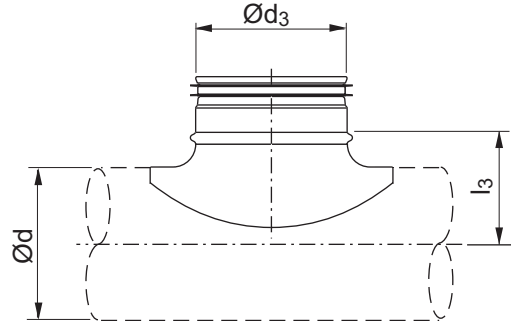

Ød nom	Ød ₃ nom	l ₃ [mm]	m kg
63	63	42	0,09
80	63	50	0,09
80	80	52	0,13
100	63	60	0,09
100	80	60	0,14
100	100	65	0,18
125	63	73	0,08
125	80	75	0,13
125	100	78	0,18
125	125	83	0,25
160	80	92	0,10
160	100	95	0,18
160	125	100	0,18
160	160	105	0,26
200	80	112	0,09
200	100	115	0,19
200	125	115	0,25
200	160	125	0,27
200	200	125	0,39
250	80	137	0,12
250	100	140	0,18
250	125	145	0,23
250	160	150	0,24
250	200	150	0,34
250	250	150	0,66
315	80	170	0,12
315	100	173	0,12
315	125	178	0,23
315	160	182	0,24
315	200	182	0,34

Tilausesimerkki

Tuotetunnus	PSU	125	100
Mitta Ød			
Mitta Ød ₃			

Lähtökäulus

PSU

Ød nom	Ød ₃ nom	l ₃ [mm]	m kg
315	250	182	0,61
315	315	182	1,22
400 *	100	215	0,12
400 *	125	220	0,23
400	160	225	0,24
400	200	225	0,44
400	250	225	0,56
400	315	225	1,03
400	400	225	1,87
500	100	265	0,12
500	125	270	0,23
500	160	275	0,25
500	200	275	0,42
500	250	275	0,55
500	315	275	0,93
500	400	275	1,75
500 *	500	290	1,87
630	100	330	0,12
630	125	335	0,23
630	160	340	0,31
630	200	340	0,40
630	250	340	0,52
630	315	340	0,93
630	400	340	1,49
630 *	500	355	1,53
630 *	630	355	2,53

T-haara ja lähtökaulus

TCPU, PSU

Tuloilma

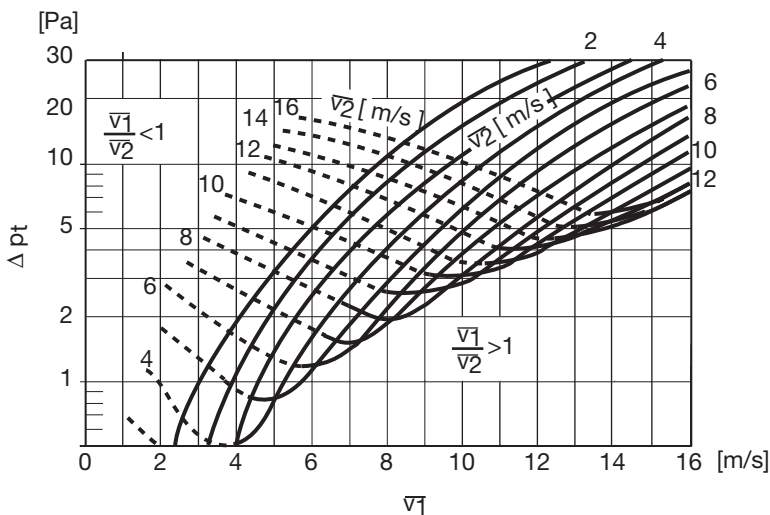
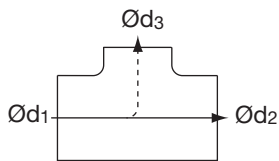
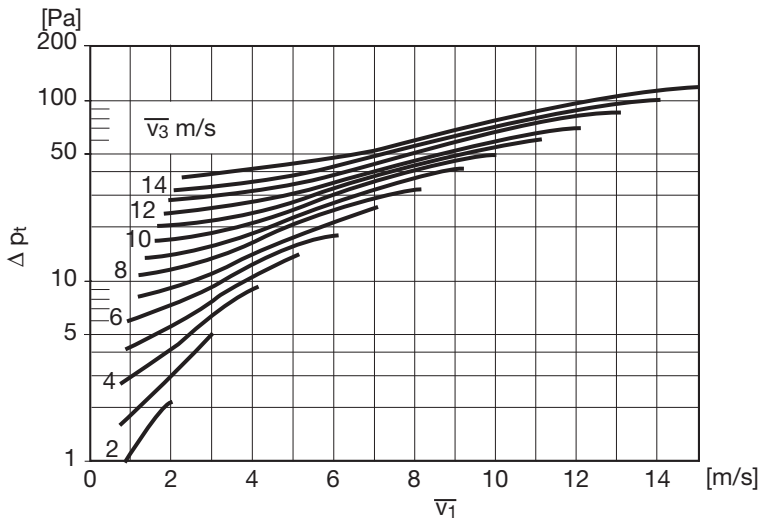
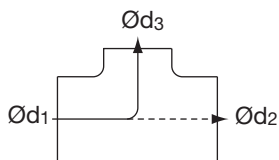

Taulukkoa voidaan käyttää myös supistukselle Ød₂.

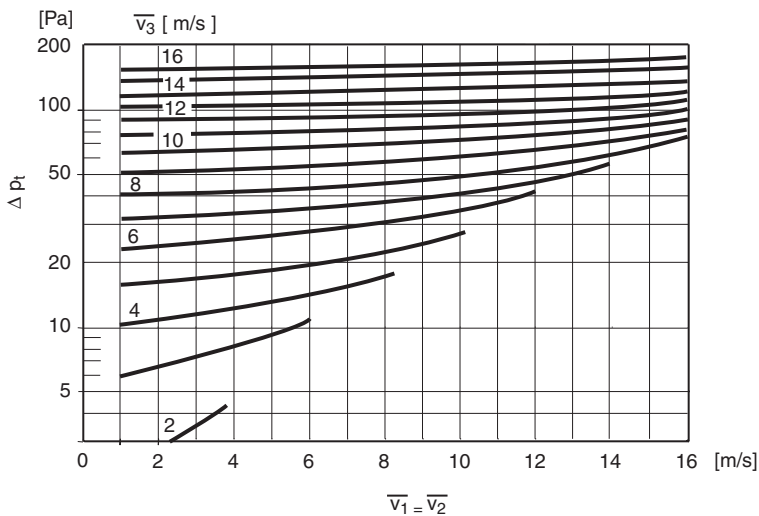
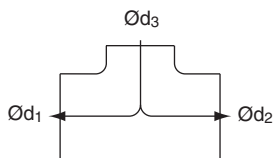

T-haara ja lähtökaulus

TCPU, PSU

Poistoilma

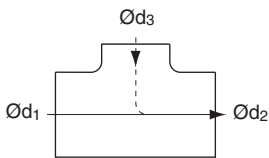
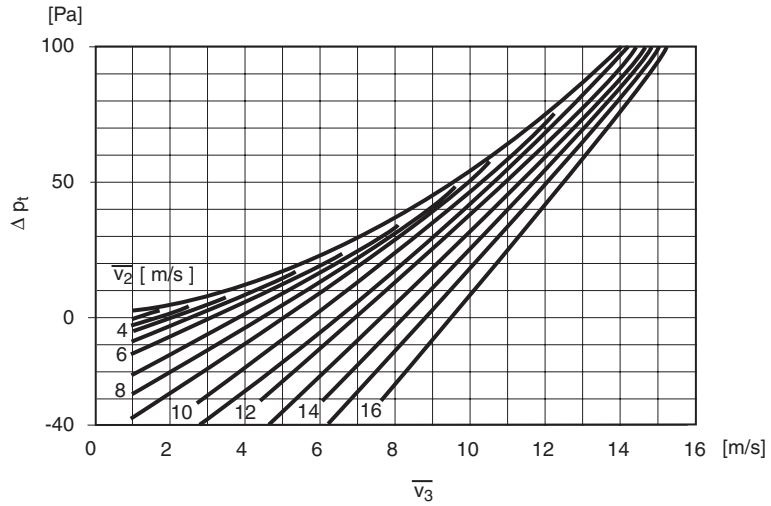
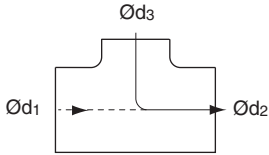

Taulukkoa voidaan käyttää myös supistukselle Ød_1 .

