

Regulating damper

DRU



Description

Has a turning, cut-off blade. The blade is stepless adjustable 0–90°. The damper admits an insulation thickness of approx. 50 mm.

The blade is designed to generate a minimum of noise. The noise is approx. the same as for a perforated blade. But the blade is less sensitive to clogging since it lacks perforations.

Setting angle α

$\alpha = 0^\circ =$ open blade, $\alpha = 90^\circ =$ closed blade

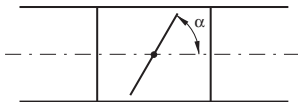

There is a separate assembly, measuring, balancing and maintenance instruction for this product.

Ø 80–1000 fullfills pressure class A in closed position.

The cup at Ø 80–630 can be complemented with the special insulation cup IK at insulation thicker than 50 mm.

Reinforced blade

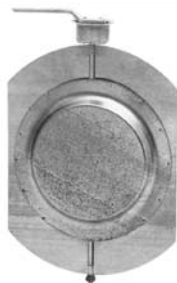

Ordering example

Product DRU 125
 Dimension Ød_1

Dimensions

Ø 80–630

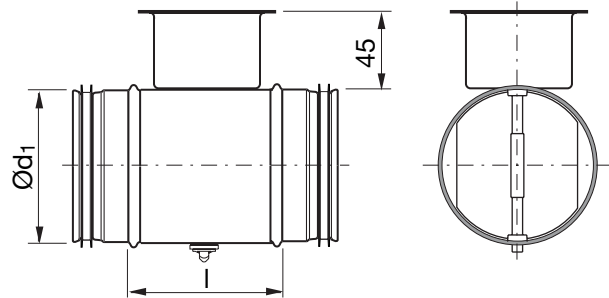

Ø 710–1000

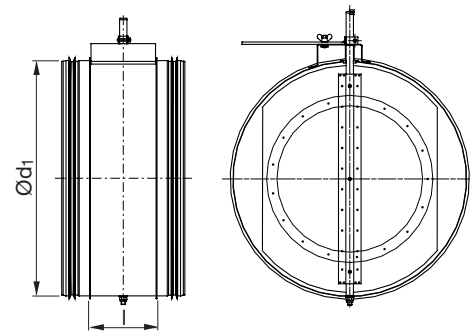

Ød ₁ nom	l [mm]	m [kg]	Sealing class past closed blade
80	100	0,34	0
100	100	0,40	0
112	100	0,43	0
125	100	0,46	0
140	100	0,54	0
150	100	0,60	0
160	100	0,65	0
180	100	0,69	0
200	100	0,80	0
224	100	0,90	0
250	100	1,28	0
280	100	1,40	0
300	100	1,62	0
315	100	1,70	0
355	100	2,01	0
400	100	2,82	0
450	100	3,70	0
500	115	4,70	0
560	115	5,51	0
600	115	5,90	0
630	115	6,21	0
710	230	15,3	0
800	230	18,2	0
900	230	21,4	0
1000	230	24,4	0



Regulating damper

DRU

Property	Ø 80-315	Ø 400	Ø 500	Ø 630	Ø 710x1000
The blade is set via a knob in a protective cup.	x	x	x	x	
The setting of the blade is read against an embossed scale at the rim of the cup.	x	x	x	x	
The blade is locked with two screws, type Pozidriv (PZD2).	x	x	x	x	
The blade has reinforced locking with a sturdy wing nut.					x
The blade is reinforced.			x	x	
The blade is additionally reinforced.					x
With sturdy handle.		x	x	x	
With additionally reinforced handle.					x
With reinforced stop beads.			x	x	
The axle is reinforced.					x
The damper can be delivered prepared for motor.	x	x	x	x	
The damper can be delivered with motor.	x	x	x	x	x

Technical data

Pressure drop graphs with noise data for dimensioning

The solid curves show the pressure drop, Δp_t , over the damper as a function of flow q , and setting angle α . The dashed curves give the A-weighted sound power data, L_{WA} , in dB to the duct.

Example

Given

Dimension Ø100
Flow 60 l/s
Pressure drop 200 Pa

Obtained from graph

Setting angle 40°
Sound power level 63 dB (A)

Ø80

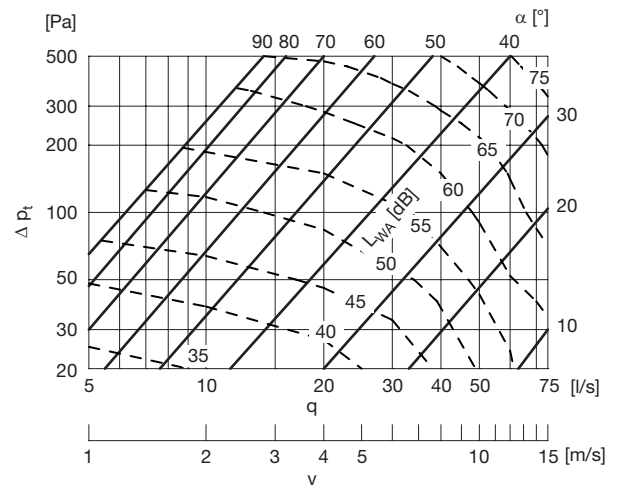

Ø100

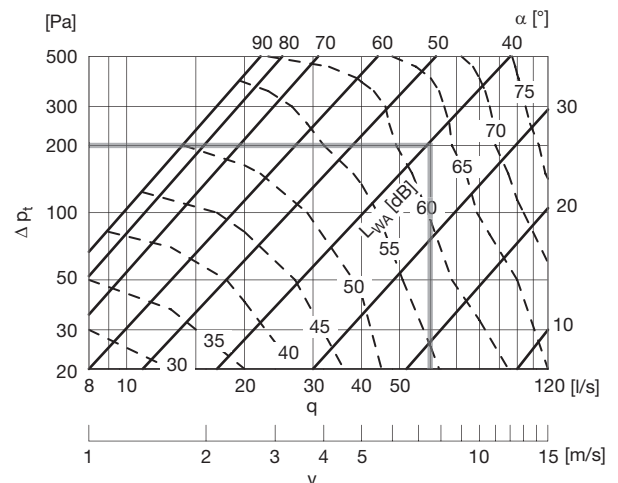

Regulating damper

DRU

Ø112

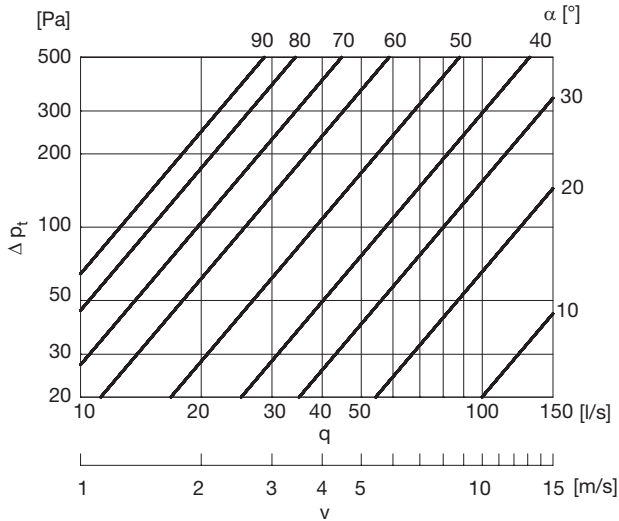

Ø150

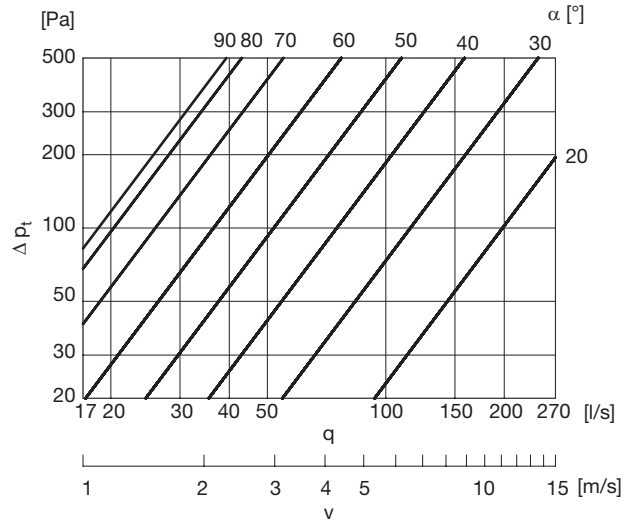

Ø125

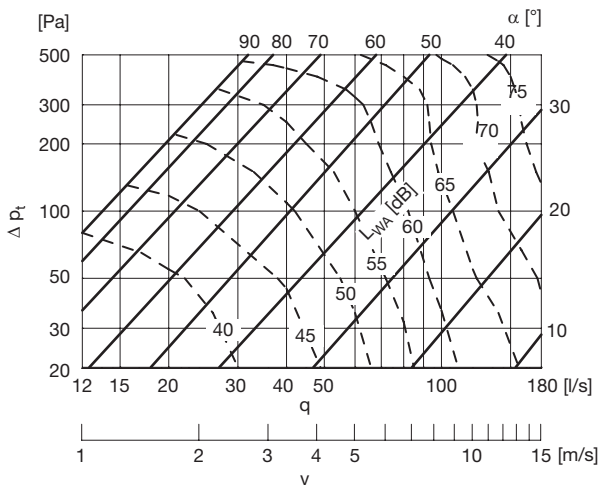

Ø160

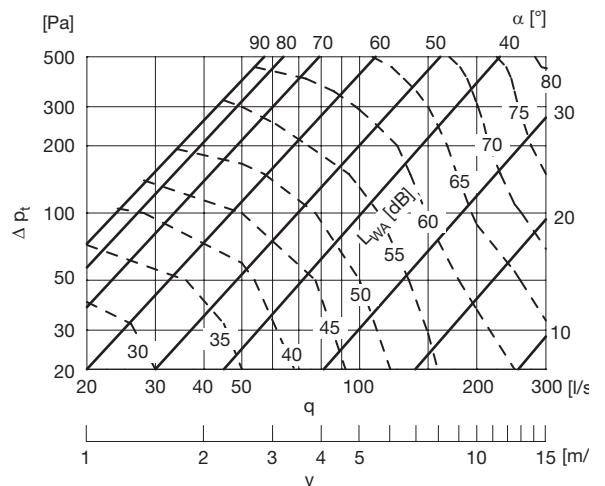

Ø140

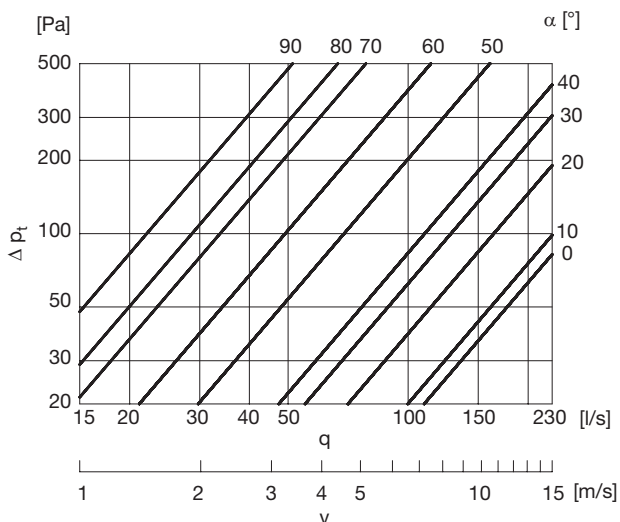

Ø180

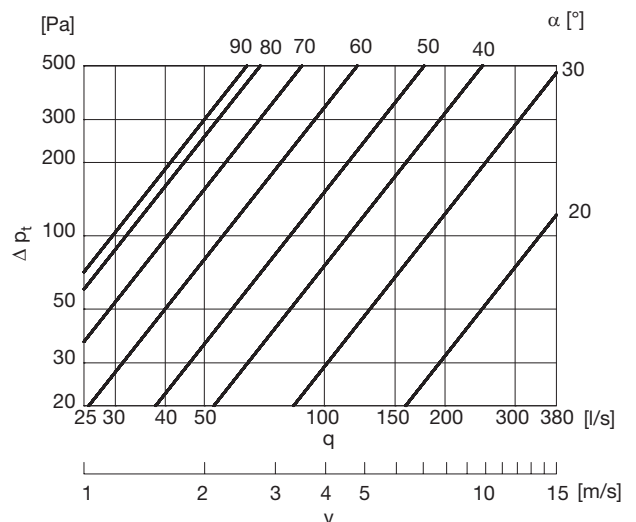

Regulating damper

DRU

Ø200

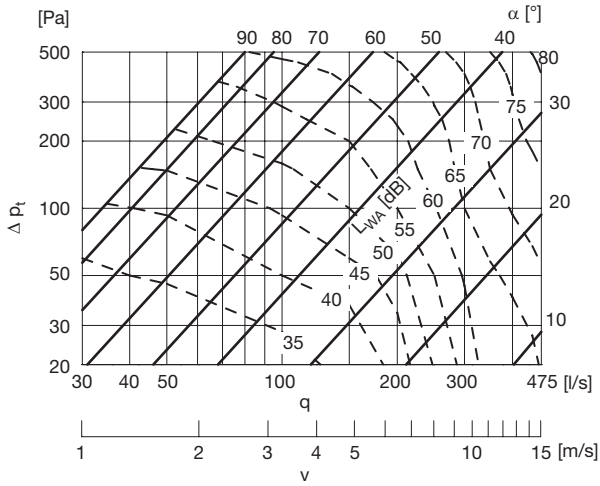

Ø280

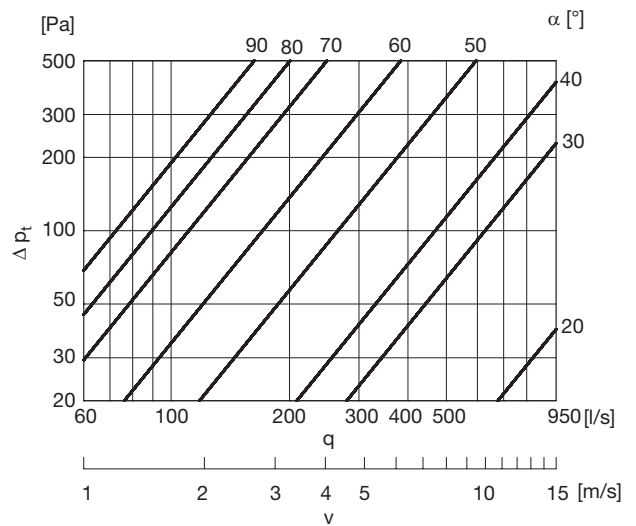

Ø224

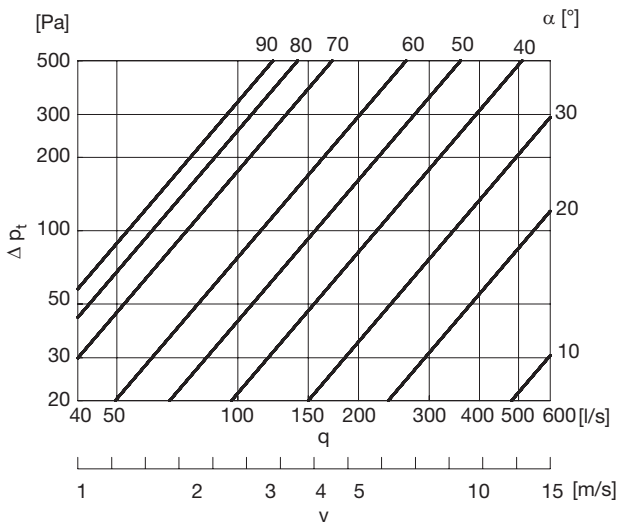

Ø300

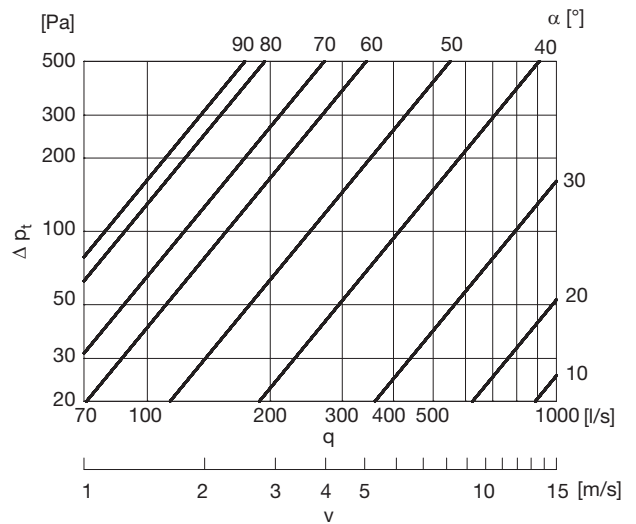

Ø250

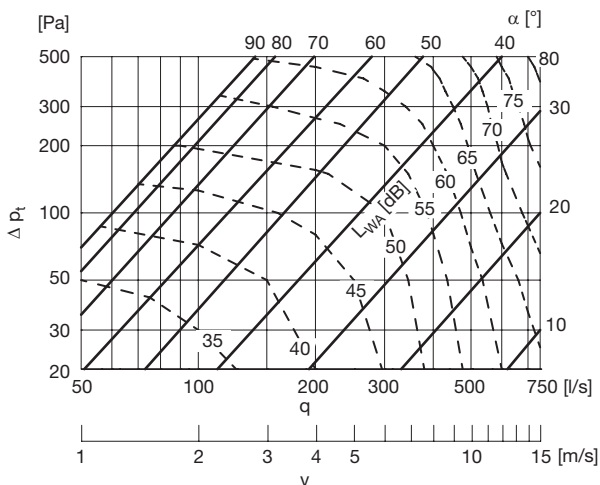

Ø315

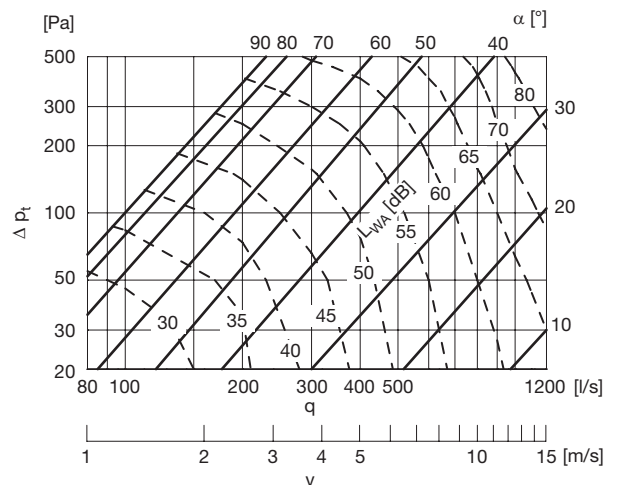

Regulating damper

DRU

Ø355

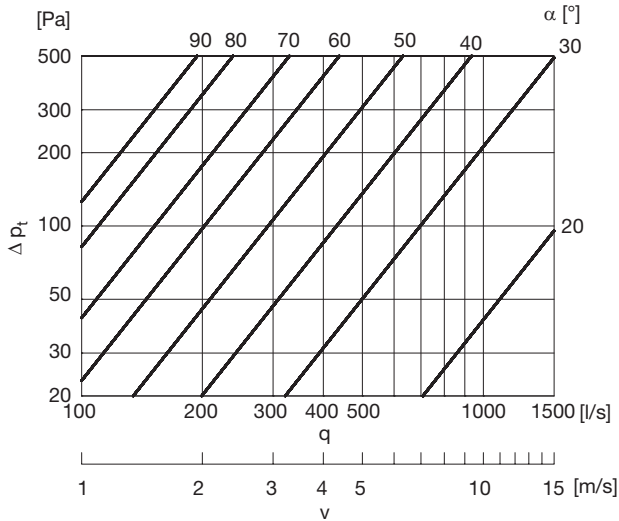

Ø500

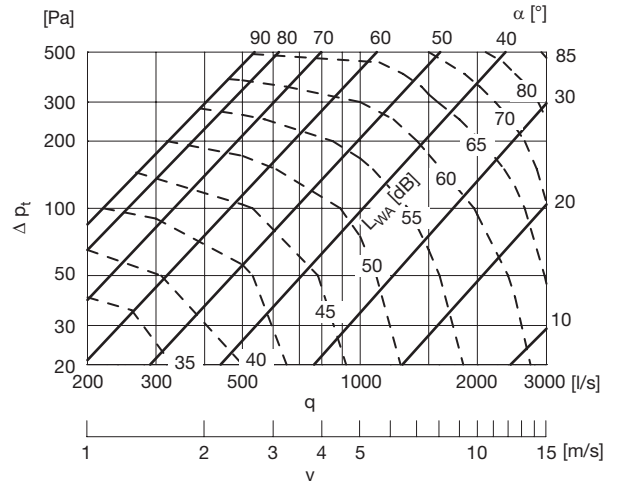

Ø400

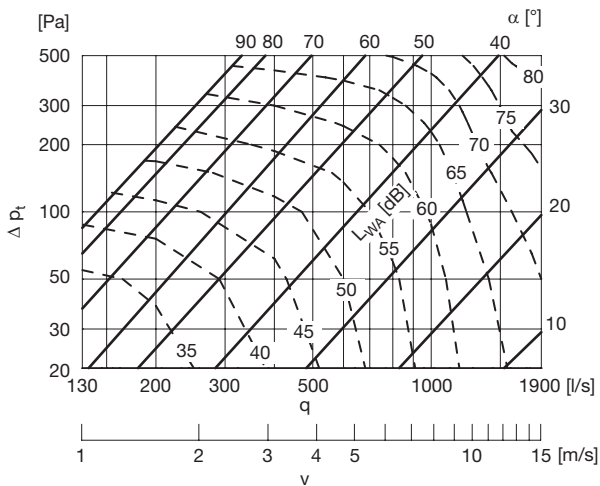

Ø560

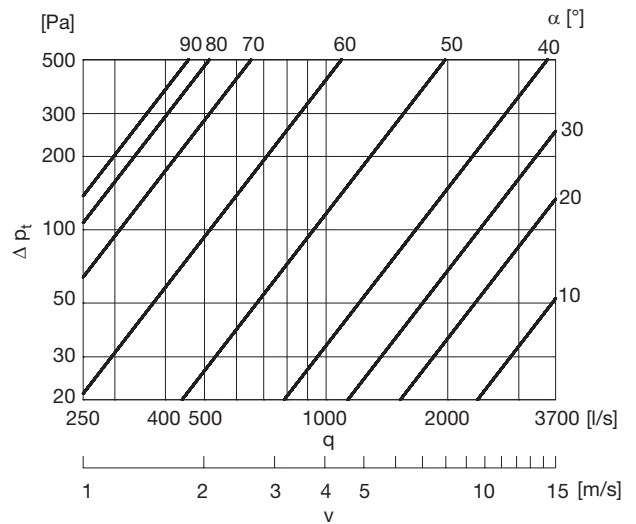

Ø450

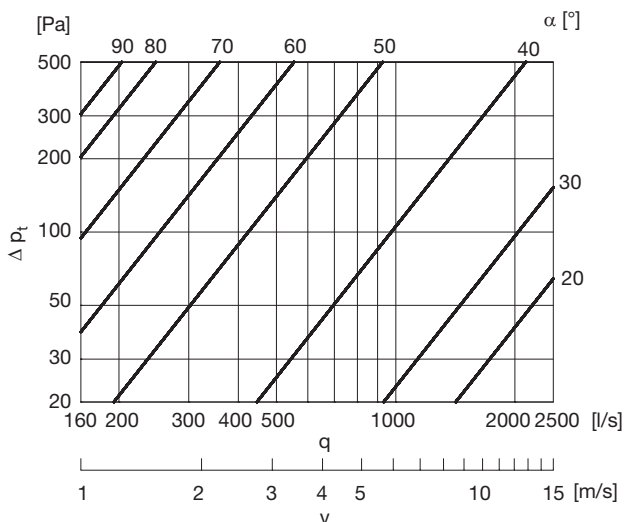

Ø600

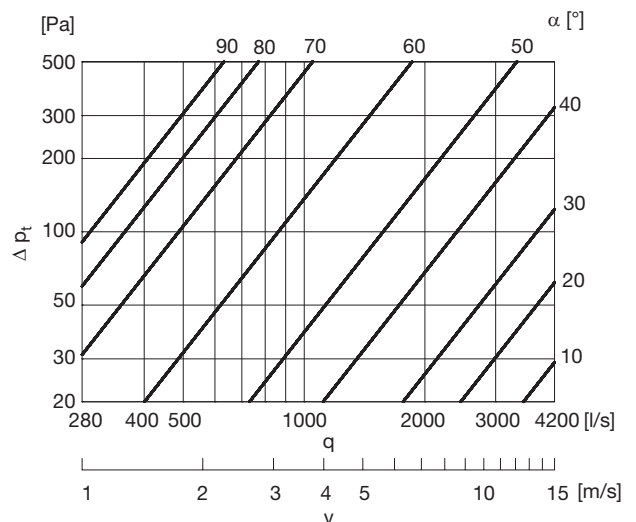

Regulating damper

DRU

Ø630

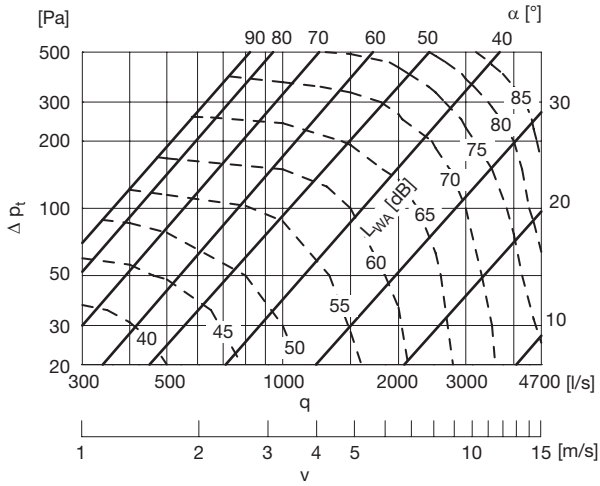

Ø900

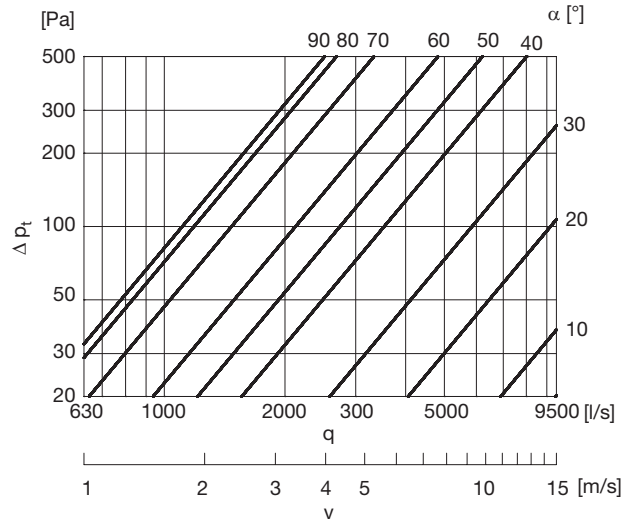

Ø710

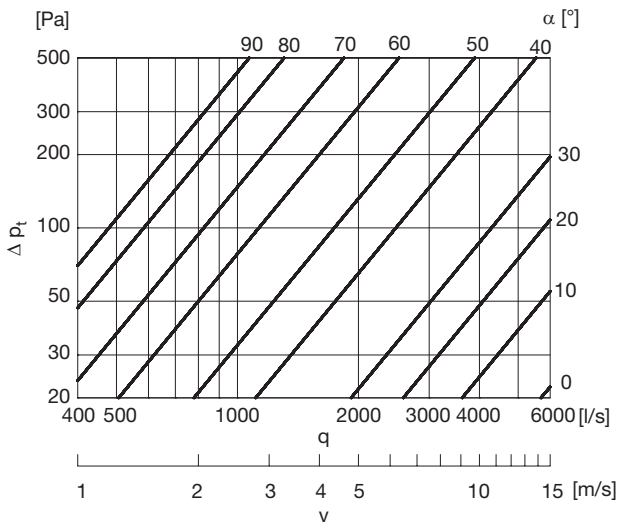

Ø1000

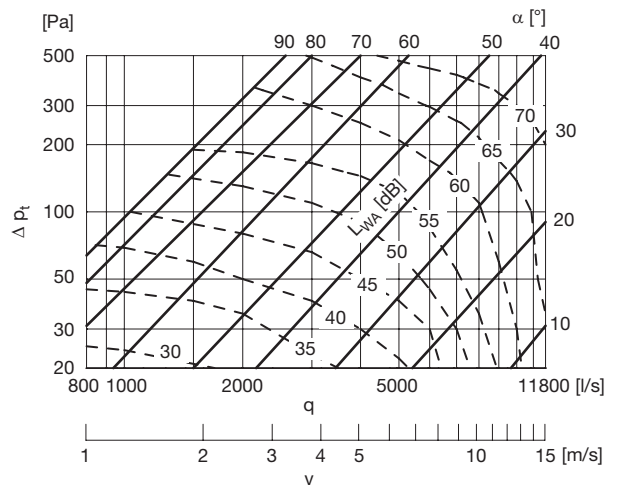

Ø800

