

# Lindab **Atrium Plana**

Heating and cooling panels



# Heating and cooling panels Atrium Plana



## Use

Lindab's heating and cooling panels are installed in the ceiling and primarily provide heating by radiation. The radiation share for the panels exceeds 50% to 60%, compared to approx. 5% for conventional fin coil products. Since the air velocities can be kept low, the result is a draught-free environment.

Radiant heating can also be used with high ceiling heights since the radiant heating, despite the high placement, heats the underlying surfaces directly without any losses to the air.

The lower temperature gradient and the increased radiation temperature provided by the panel results in an energy-efficient heating alternative compared to other heating systems.

## Installation

Atrium Plana is installed either exposed or recessed in a suspended ceiling.

## Worth noting

A high radiation quotient results in low air velocities and provides excellent results, even when high installation heights apply. The low weight ensures quick and effortless installation.

Lindab's radiant panels are tested according to EN-14037/EN-14240 and are CE-marked.

## Key figures

Length:	600, 1200, 1800, 2400, 3000, 3600 mm
Width:	400, 600, 900, 1200 mm
Height:	35 mm
Capacity:	Cooling: 718 W or 168 W/m <sup>2</sup>
	Heating: 1260 W or 295 W/m <sup>2</sup>

## Calculation setup

Room temp: 25°C/21°C, Water temp: 14-17°C/55-45°C.

# Heating and cooling panels Atrium Plana

## Atrium Plana

The Lindab Atrium Plana is a simple yet powerful radiant panel, with an uncomplicated design that ensures that the Atrium Plana does not draw attention on the building and interior design.

The water pipes are made of copper. Nevertheless, water should be oxygen-free to prevent corrosion.

## Atrium Plana H, Heating

When warm water passes through the copper pipe, heat is transferred to the aluminium plate, with very little temperature loss thanks to the unique welding technique. The panel is warmed and it then radiates the heat into the room. The thermal radiation travels through the air without any loss of energy on its way to the floor, walls and room objects. In this way, you avoid heating a large air mass that, when warm, sticks to the ceiling. Instead, the heat goes where it is needed the most. It is mainly the floor, walls, furniture and fittings in the room that are heated. The temperature of the room surfaces becomes higher than that of the room air and thus transfers its heat to the air. By heating primarily the room surfaces instead of the air, you can save a lot of energy. The Atrium Plana H is equipped with Lindab standard insulation on the top to avoid heat radiation towards the ceiling. A more detailed description of how ceiling heating works is available in Lindab's Ceiling Heating Guide.

## Atrium Plana C, Cooling

When cold water passes through the panel, the heat of the aluminium plate, absorbed from the hot room air, is transferred to the cold water, with very little temperature loss. The panel partly chills the warm room air on its cold surfaces and, partly absorbs heat from the room via low-temperature radiation. In this way, the room is chilled via both radiation (approx. 50%) and convection. The absorption of low-temperature radiation means that the surfaces of the room, and above all the floor, walls, furniture and fittings have a lower temperature than if then cooling was only convective. This means that storage of "cooling energy" is greater. The Atrium Plana C is not equipped with insulation but is colored on the top also to enable best emission of radiation towards the ceiling.

## Atrium Plana HC, Heating+Cooling

By adding an extra set of copper pipes, a single Atrium Plana panel can be used for both heating and cooling. The Atrium Plana HC is equipped with Lindab standard insulation on the top to avoid heat radiation towards the ceiling.

## Design

The design of the panels is based on a unique manufacturing process. Optimal energy transfer is secured by a high precision laser welding and offers near-to-lossless transfer of heat energy between the copper piping and the aluminium distribution plate. Lindab delivers the lightest and most effective radiant panel on the market.

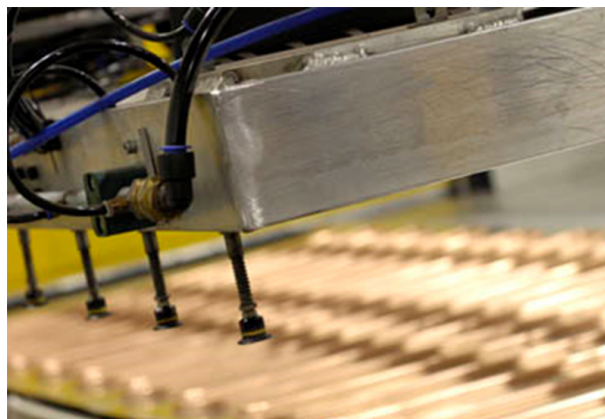

Picture 1: Atrium Plana unique manufacturing process.

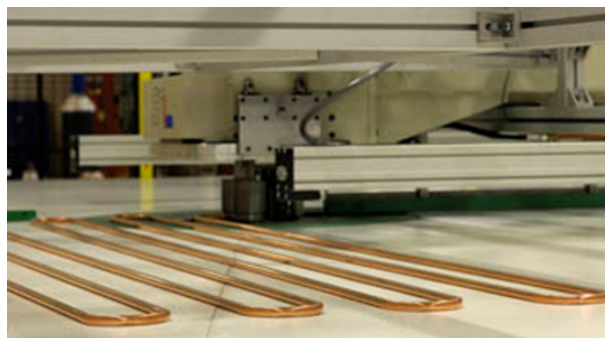

Picture 2: Atrium Plana high precision laser welding.

Atrium Plana H is a flat heating panel with a sleek and soft design. It is made out of a thin aluminium plate with laser welded copper pipes on top and insulated with extruded polystyrene foam and should not be placed in direct sunshine or underneath other heating- or ignition sources. Sparks and smoke must be avoided. (manufactured without the addition of CFC or HCFC gas i. e. freons) to avoid heat radiation towards the ceiling. Atrium Plana H is available as standard in signal white RAL 9003 or in pure white RAL 9010 and can be installed recessed into the suspended ceiling, exposed free hanging or exposed sealed directly to the ceiling. Atrium Plana-H should be used if the panel is to provide maximum heating with a so-called 2-pipe "Change-Over"-system.

Atrium Plana C is a flat cooling panel with a sleek and soft design. It is made out of a thin aluminium plate with laser welded copper pipes on top and powder coated to enable absorption of heat. Atrium Plana C is available as standard in signal white RAL 9003 or in pure white RAL 9010 and can be installed recessed into the suspended ceiling, exposed free hanging or exposed sealed directly to the ceiling. Atrium Plana-C should be used if the panel

# Heating and cooling panels Atrium Plana

is to provide maximum cooling capacity within a 2-pipe-system or in a Change-Over"-system when heating is of minor importance.

Atrium Plana HC is a flat combined heating and cooling panel with a sleek and soft design. It is made out of a thin aluminium plate with laser welded copper pipes on top and insulated with extruded polystyrene foam and should not be placed in direct sunshine or underneath other heating- or ignition sources. Sparks and smoke must be avoided. (manufactured without the addition of CFC or HCFC gas i. e. freons) to avoid heat radiation towards the ceiling.

Atrium Plana HC is available as standard in signal white RAL 9003 or in pure white RAL 9010 and can be installed recessed into the suspended ceiling, exposed free hanging or exposed sealed directly to the ceiling. Atrium Plana-HC should be used if the panel is to provide separate cooling and heating with a so-called 4-pipe-system.

## Data

### Variants

**Width:** The panels are available in four different widths for either cooling (C-), heating (H-) or combined heating and cooling (HC-): 40 (392 mm), 60 (592 mm), 90 (892 mm) and 120 (1192 mm).

**Lengths:** The panels are available in lengths: 0.6 – 1.2 – 1.8 – 2.4 – 3.0 – 3.6 m.

**Height:** The height of all panels is 35 mm.

**Water connection:** Available with vertical, horizontal or bended DN10 connection. Type H-/C- with 2-Pipe connection and type HC- with 4-pipe connection.

**Surface treatment:** The panels are made out of aluminium and are powder-coated.

**Design:** Atrium Plana is supplied as standard with a plane, closed surface. Depending on light situation, installation principle and placing in the room the piping on top might be visible from below. We recommend to order a sample to clarify your demands/requirements.

**Insulation:** H- and HC panels are insulated with white extruded polystyrene foam and should not be placed in direct sunshine or underneath other heating- or ignition sources. Sparks and smoke must be avoided. (manufactured without the addition of CFC or HCFC gas i. e. freons).

For full technical data sheet please contact Lindab.

### Colour

The product is available as standard, in fine textured powder coating in signal white RAL 9003 or in pure white RAL 9010, gloss value  $5 \pm 1$ . Other RAL colours on request.

## Plus features

Factory preinstalled.

**Design:** Four different perforation patterns are also available (see page 6, Atrium Plana Design). Depending on light situation, installation principle and placing in the room the piping on top might be visible from below. For perforation type "2 – full M6" and "4- full U8" it is visible through the perforation.

**Acoustic Insulation:** With ACUTEK® ATTENUATION MATERIAL instead of Lindab standard insulation. 30mm thick laminated or unlaminated fabric surface (Faced with 100% PES, thermally laminated; washable, nylon brush cleaning, vacuum cleaning Fire-class B-s1-d0 tested according standard EN 13501-1: 2007). For full technical data sheet please contact Lindab.

## Accessories

Delivered separately.

**Control:** Refer to the chapter Regula.

**Hangers:** Preparation for installation of hangers (4 pcs if  $L_{nom} < 2.4$  m and 6 pcs if  $L_{nom} \geq 2.4$  m). For recommended installation principles (see page 14 or "[Atrium Plana Installation Instruction](#)"):

### Suspension hooks:

For a better installation with both pendulum hangers and threaded rods, we recommend our suspension hooks (4 or 6 pcs).

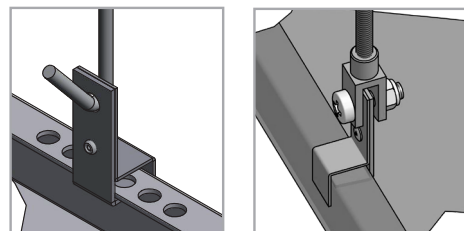

### Pendulum hanger:

Pendulum hangers of different sizes.

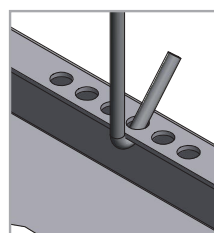

# Heating and cooling panels Atrium Plana

## For exposed installation but sealed directly on ceiling:

Mounting bracket for installation directly to ceiling/concrete ceilings are available in all different panel width 40, 60, 90 and 120 mm.

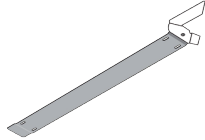

## For installation recessed in a suspended ceiling:

Mounting clips help to position the panel in the suspended ceiling system.

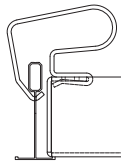

Details and instruction of how to use all available hangers please refer to: "[Atrium Plana Installation Instruction](#)".

For additional accessories please refer to the "[Accessories](#)" document on [www.lindQST.com](http://www.lindQST.com).

## Dimensioning of heating panels

Radiant heating is an excellent heating system with lots of advantages such as lower energy consumption, quick response and more uniform room temperature compared to other heating systems. Placement in the ceiling also means that the radiant heat directly affects all underlying exposed surfaces visible from the panel. Walls are free from radiators and allow a more flexible use of the room's surfaces. Lindab has produced a "[Ceiling heating guide](#)", with advice on how to achieve the best possible indoor climate and what to think about in connection with dimensioning and placement.

The heating capacity from the radiant panels depends on the temperature difference between the panel surface and the surfaces to be heated. The water flow and the turbulence of the water also affect the power output. For a correct dimensioning for your particular operating case, use our [Waterborne calculation](#) for Atrium Plana.

# Heating and cooling panels — Atrium Plana

## Atrium Plana Design

For design demands there are two different perforation types available (U8 and M6), each with two different pattern (full and slot). This gives four additional opportunities for the visible front of an Atrium Plana panel. Please take that into account for capacity calculation. For accoustical performance please contact us for more details.

### Standard face plates without perforation

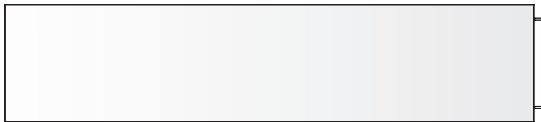

### Atrium Plana Perforation

#### U8 (Square)

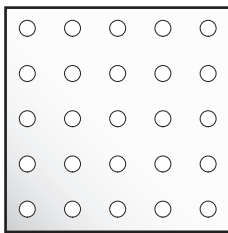

Ø3.00 U 8.485 (9.82%)

#### M6 (Diagonal)

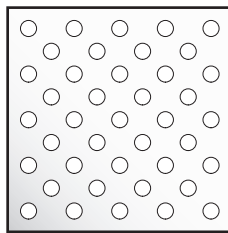

Ø3.00 M 6.00 (19.64%)

### Pattern



#### 1. Slot M6



#### 2. Full M6



#### Slot M6 Detail

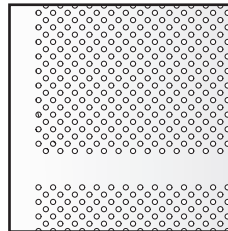

#### Full M6 Detail

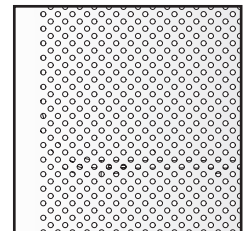

#### 3. Slot U8

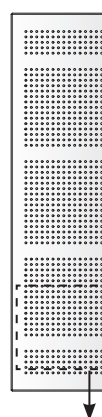

#### 4. Full U8

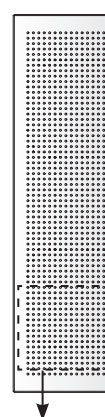

#### Slot U8 Detail

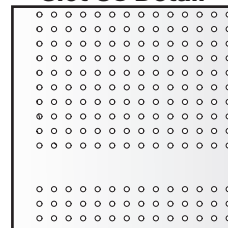

#### Full U8 Detail

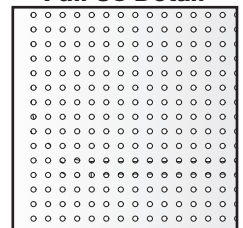

# Heating and cooling panels Atrium Plana

## Dimensioning

### Heating capacity water $P_w$

Follow the instructions below, to calculate the heating capacity  $P_w$  provided by the heating panel.

1. Calculate temperature difference  $\Delta t_{rw}$ .
2. Product length  $L$  minus 0.1 m, to obtain the active length  $L_{act}$ .
3. Find the specific heating capacity  $P_{Lt}$ , relative to  $\Delta t_{rw}$ , in diagram 1.
4. Multiply the specific heating capacity with the active length  $L_{act}$ .

**NB!** Please use the multiplication factor in table 1 and 2 to calculate the heating capacity when using other than Atrium Plana H-60.

**NB!** The capacity diagram applies at a nominal flow  $q_{wnom} = 0.0135$  l/s. Follow the steps in example 3, to obtain the right capacity at other flows.

**NB!** For easy calculation use [Waterborne Calculator](#) on lindQST.

#### Definitions:

$P_a$	= Cooling capacity air [W]
$P_w$	= Cooling capacity water [W]
$P_{tot}$	= Cooling capacity total [W]
$q_{ma}$	= Air mass flow rate [kg/s]
$q_a$	= Primary air flow rate [l/s]
$q_w$	= Water flow rate [l/s]
$q_{wmin}$	= Minimal water flow rate [l/s]
$q_{wnom}$	= Nominal water flow rate [l/s]
$c_{pa}$	= Specific heat capacity air [1.004 kJ/kg K]
$t_r$	= Room air temperature [°C]
$t_{wi}$	= Water inlet temperature [°C]
$t_{wo}$	= Water outlet temperature [°C]
$\Delta t_{ra}$	= Temp. diff., room air and primary air temp. [K]
$\Delta t_{rw}$	= Temp. diff., room air and mean water temp. [K]
$\Delta t_w$	= Temp. diff. water circuit [K]
$\varepsilon_{\Delta tw}$	= Capacity correction for temperature
$\varepsilon_{qw}$	= Capacity correction for water flow
$P_{Lt}$	= Specific cooling capacity [W/K]
$\zeta_{\Delta twio}$	= Pressure drop factor for temperature

### Example 1, Heating:

What is the heating capacity  $P_w$  of a 3.0 m exposed, free hanging standard panel Atrium Plana H-60?  
The room's winter temperature is assumed to be  $t_r = 21^\circ\text{C}$ .  
The heating water temperature in/out is  $60/55^\circ\text{C}$ .

#### Answer:

Temperature difference:

$$\Delta t_{rw} = (t_{wi} + t_{wo})/2 - t_r = (60^\circ\text{C} + 55^\circ\text{C}) / 2 - 21^\circ\text{C} = 36.5 \text{ K}$$

Active length:

$$L_{act} = 3.0 \text{ m} - 0.1 \text{ m} = 2.9 \text{ m}$$

Read off from diagram 1.  $P_{LT} = 245 \text{ W/m}$ .

$$P_w = 245 \text{ W/m} \times 2.9 \text{ m} = 711 \text{ W}$$

Heating Capacity	
Width	Multiplication Factor
H-40	0.667
H-60	1.000
H-90	1.500
H-120	2.000

Table 1. Multiplication factor heating capacity for H.

Heating Capacity	
Width	Multiplication Factor
HC-40	0.620
HC-60	0.940
HC-90	1.140
HC-120	1.300

Table 2. Multiplication factor heating capacity for HC.

# Heating and cooling panels Atrium Plana

## Atrium Plana H 60 - Specific heating capacity $P_{LT}$

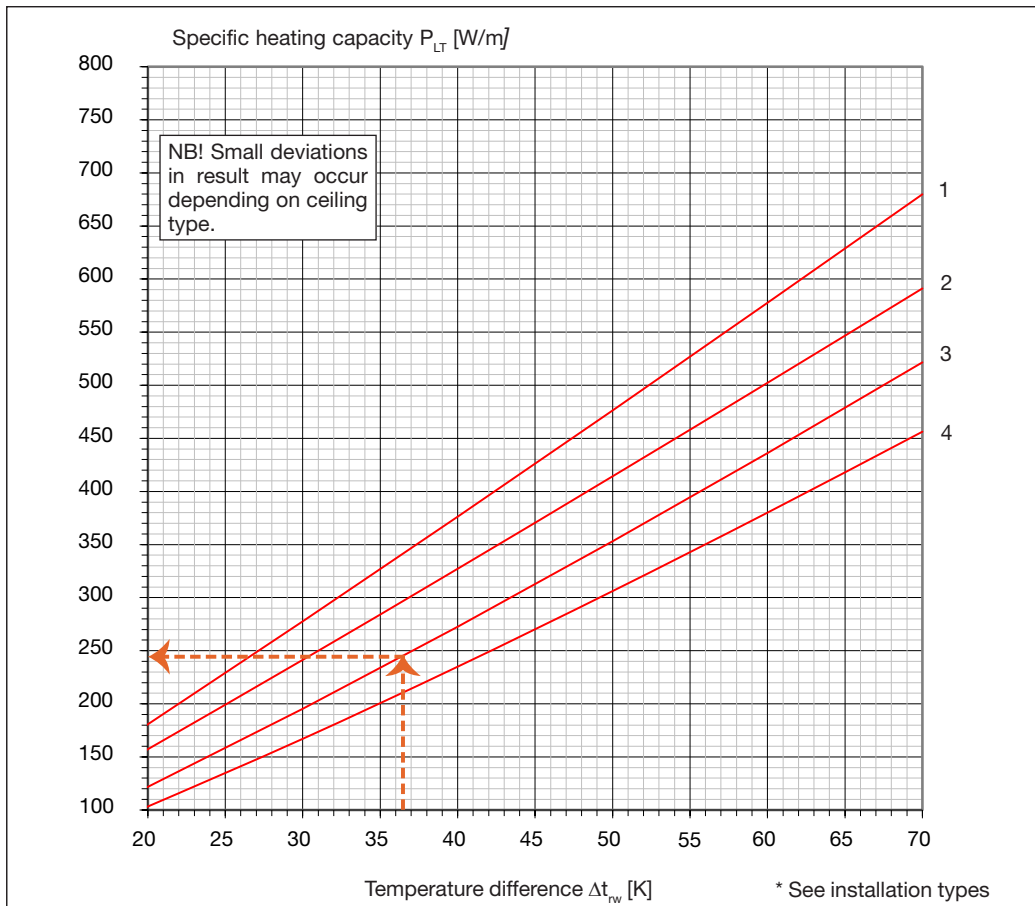

Diagram 1. Atrium Plana, specific heating capacity  $P_w$  per active length at nominal flow,  $q_{wnom} = 0.0135$  in relation to Temperature difference  $\Delta t_{rw}$

Curve	Installation type	Perforation type	Insulation type	Related to
1	3	All types*	None	-
2	3	None	None	-
3	1, 2, 3	All types*	Standard	-
3	1, 2, 3	None	Standard	-
3	1, 2	All types*	None	-
3	1, 2	None	None	-
4	1, 2, 3	All types*	Additional 50 mm	EN 14037
4	1, 2, 3	None	Additional 50 mm	EN 14037

Table 3. Curves legend for Diagram 1.

\* See page 6.

### Installation types

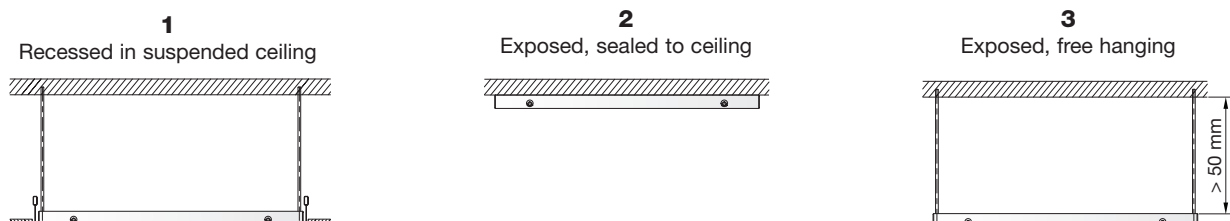



# Heating and cooling panels Atrium Plana

## Dimensioning

### Cooling capacity water $P_w$

Follow the instructions below, to calculate the cooling capacity  $P_w$  provided by the cooling panel.

1. Calculate temperature difference  $\Delta t_{rw}$ .
2. Product length  $L$  minus 0.1 m, to obtain the active length  $L_{act}$ .
3. Find the specific heating capacity  $P_{Lt}$ , relative to  $\Delta t_{rw}$ , in diagram 2.
4. Multiply the specific heating capacity with the active length  $L_{act}$ .

**NB!** Please use the multiplication factor in table 4 and 5 to calculate the cooling capacity when using other than Atrium Plana C-60.

**NB!** The capacity diagram applies at a nominal flow  $q_{wnom} = 0.028$  l/s. Follow the steps in example 4, to obtain the right capacity at other flows.

**NB!** For easy calculation use the LindQST [Waterborne Calculator](#).

#### Definitions:

- $P_a$  = Cooling capacity air [W]
- $P_w$  = Cooling capacity water [W]
- $P_{tot}$  = Cooling capacity total [W]
- $q_{ma}$  = Air mass flow rate [kg/s]
- $q_a$  = Primary air flow rate [l/s]
- $q_w$  = Water flow rate [l/s]
- $q_{wmin}$  = Minimal water flow rate [l/s]
- $q_{wnom}$  = Nominal water flow rate [l/s]
- $c_{pa}$  = Specific heat capacity air [1.004 kJ/kg K]
- $t_r$  = Room air temperature [°C]
- $t_{wi}$  = Water inlet temperature [°C]
- $t_{wo}$  = Water outlet temperature [°C]
- $\Delta t_{ra}$  = Temp. diff., room air and primary air temp. [K]
- $\Delta t_{rw}$  = Temp. diff., room air and mean water temp. [K]
- $\Delta t_w$  = Temp. diff. water circuit [K]
- $\epsilon_{\Delta tw}$  = Capacity correction for temperature
- $\epsilon_{qw}$  = Capacity correction for water flow
- $P_{Lt}$  = Specific cooling capacity [W/K]
- $\zeta_{\Delta twio}$  = Pressure drop factor for temperature

### Example 2, Cooling:

What is the cooling capacity of a 3.0 m Atrium Plana C-120 suspended installation?

The room's summer temperature is assumed to be  $t_r = 24.5^\circ\text{C}$ . The cooling water temperature in/out of the Atrium Plana is 14/17°C.

#### Answer:

Temperature difference:  $\Delta t_{rw} = t_r - (t_{wi} + t_{wo})/2$   
 $\Delta t_{rw} = 24.5 - (14+17) / 2 = 9 \text{ K}$

Active length:  $L_{act} = 3.0 \text{ m} - 0.1 \text{ m} = 2.9 \text{ m}$

Read off, from diagram 2:  $P_{Lt} = 68 \text{ W/m}$

Multiply the specific cooling capacity by the multiplication factor for cooling capacity from table 4 for C-120:

$\Rightarrow P_{Lt} = 68 \text{ W/m} \times 2.0 = 136 \text{ W/m}$

The cooling capacity  $P_w$  is:  
 $P_w = 136 \text{ W/m} \times 2.9 \text{ m} = 394 \text{ W}$

Cooling Capacity	
Width	Multiplication factor
C-40	0.667
C-60	1.000
C-90	1.500
C-120	2.000

Table 4. Multiplication factor cooling capacity for C.

Cooling Capacity	
Width	Multiplication factor
HC-40	0.667
HC-60	1.000
HC-90	1.430
HC-120	1.910

Table 5. Multiplication factor cooling capacity for HC.

# Heating and cooling panels Atrium Plana

## Atrium Plana C 60 - Specific cooling capacity $P_{LT}$

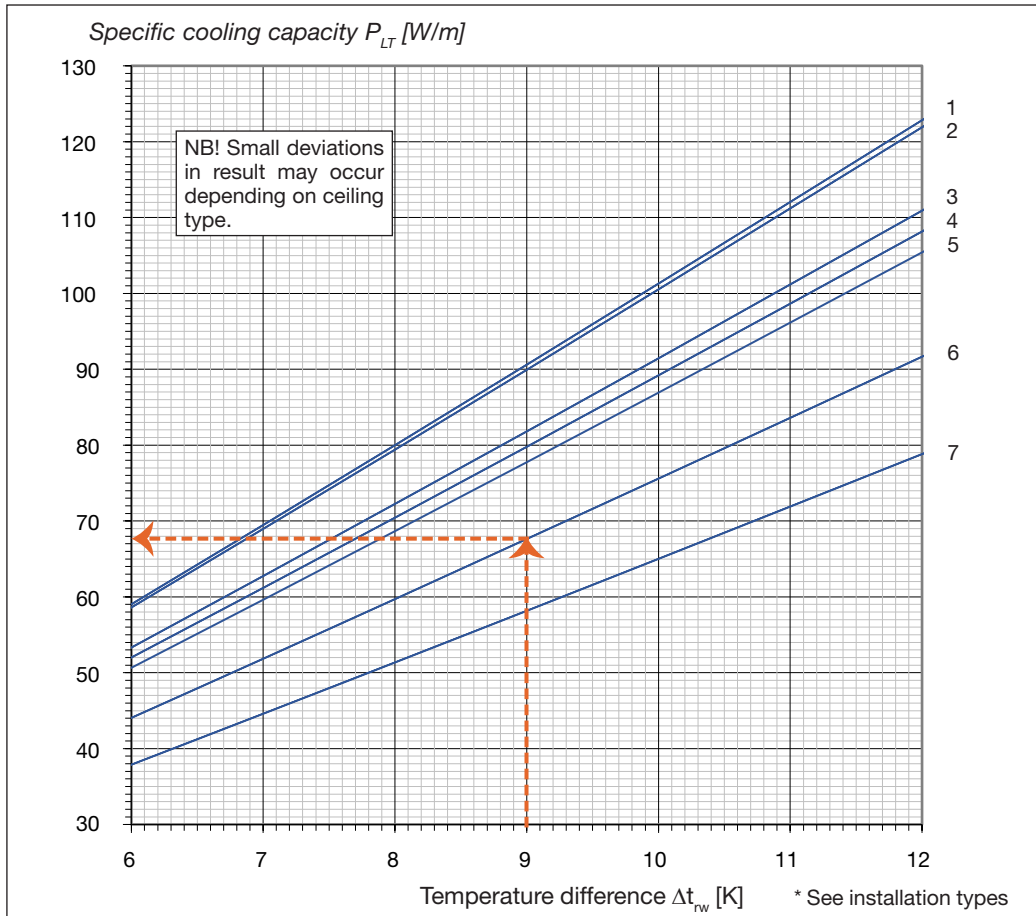

Diagram 2. Atrium Plana specific cooling capacity  $P_{LT}$  per active length at the nominal flow  $q_{wnom} = 0.028$  l/s.

Curve	Installation type	Perforation type	Insulation type	Related to
1	3	Full-M6	None	-
2	3	Slot-M6	None	-
3	3	Full-U8	None	-
4	3	Slot-U8	None	-
5	3	All types*	None	EN 14240
6	3	None	None	EN 14240
7	1, 2	None	None	-
7	1, 2, 3	None	Standard	-
7	1, 2, 3	All types*	Standard	-
7	1,2	All types*	None	-

Table 6. Curves legend for Diagram 2.

\* See page 6.

### Installation types

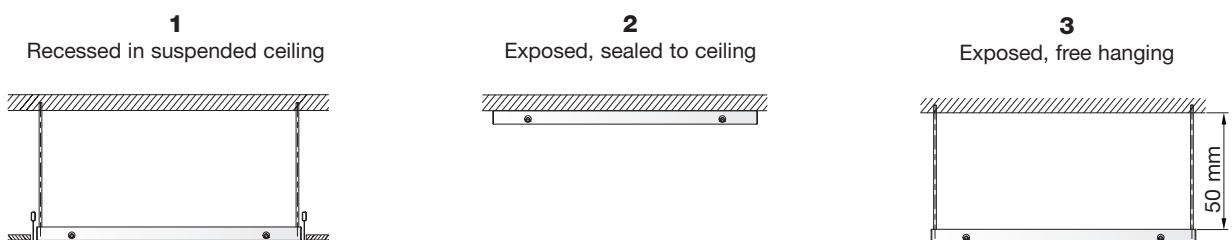

# Heating and cooling panels Atrium Plana

## Dimensioning

### Capacity correction for water flow $\epsilon_{q_w}$

#### Follow the steps below:

1. Calculate the water flow  $q_w$  with the current capacity  $P_w$ .
2. Read off the capacity correction for waterflow  $\epsilon_{q_w}$  from diagram 3.
3. Multiply the capacity  $P_w$  by the capacity correction  $\epsilon_{q_w}$ .
4. Repeat steps 1 through 4 with the new capacity.

#### Example 3, Heating:

Atrium Plana H-60 gives  $P_w = 711 \text{ W}$  (from example 1).  
 Temperature difference was:  $\Delta t_w = 60^\circ\text{C} - 55^\circ\text{C} = 5 \text{ K}$ .

To calculate the water flow rate, use formula:

$$q_w = P_w / (c_{pw} \times \Delta t_w)$$

$$q_w = 711 \text{ W} / (4200 \text{ Ws}/(\text{kg K}) \times 5 \text{ K}) = 0.0338 \text{ l/s.}$$

Read off the capacity correction  $\epsilon_{q_w}$  from diagram 3.  
 The value is  $\epsilon_{q_w} = 1.037$ .

Calculate the new capacity:  $P_w = 711 \text{ W} \times 1.037 = 737 \text{ W}$ .

Use the new capacity to calculate the water flow rate:  
 $q_w = 737 \text{ W} / (4200 \text{ Ws}/(\text{kg K}) \times 5 \text{ K}) = 0.0351 \text{ l/s.}$

The new capacity correction  $\epsilon_{q_w}$  will then be 1.038 and the new capacity is calculated to be:  
 $P_w = 711 \text{ W} \times 1.038 = 737 \text{ W}.$

### Example 4, Cooling:

Atrium Plana C-120 gives  $P_w = 394 \text{ W}$  (from example 2).  
 Temperature difference was:  $\Delta t_w = 17^\circ\text{C} - 14^\circ\text{C} = 3 \text{ K}$ .

To calculate the water flow rate, use formula:

$$q_w = P_w / (c_{pw} \times \Delta t_w)$$

$$q_w = 394 \text{ W} / (4200 \text{ Ws}/(\text{kg K}) \times 3 \text{ K}) = 0.0313 \text{ l/s.}$$

Read off the capacity correction  $\epsilon_{q_w}$  from diagram 3.  
 The value is 1.015.

Calculate the new capacity:  $P_w = 394 \text{ W} \times 1.015 = 400 \text{ W}$ .

Use the new capacity to calculate the new water flow rate:  
 $q_w = 400 \text{ W} / (4200 \text{ Ws}/(\text{kg K}) \times 3 \text{ K}) = 0.03178 \text{ l/s.}$

Read off the capacity correction  $\epsilon_{q_w}$  from diagram 3 again.  
 The value is 1.015.

Calculate the new capacity:  
 $P_w = 394 \text{ W} \times 1.015 = 400 \text{ W}.$

Seeing that the flow is near stable at this point in the calculation, the cooling capacity is calculated to be 400 W.

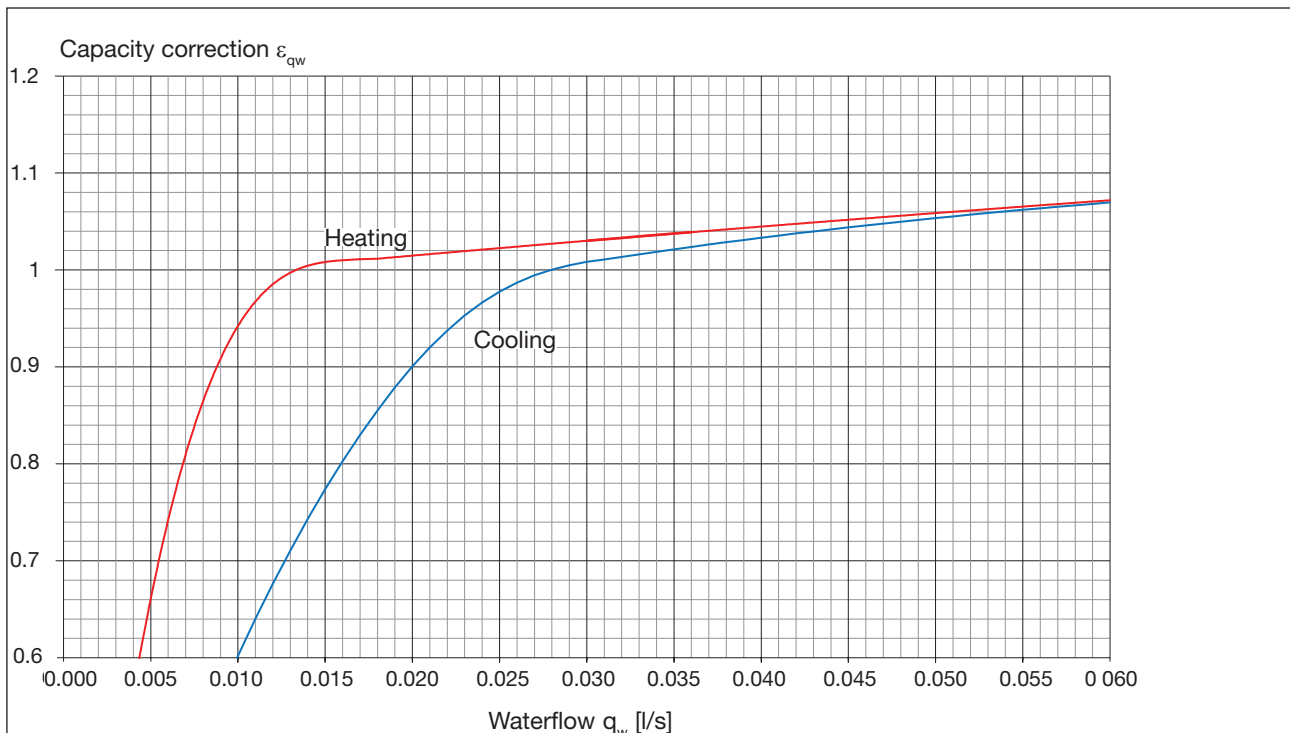

Diagram 3. Capacity correction  $\epsilon_{q_w}$  as a function of waterflow  $q_w$ .

# Heating and cooling panels Atrium Plana

## Pressure drop in water circuit, width 60

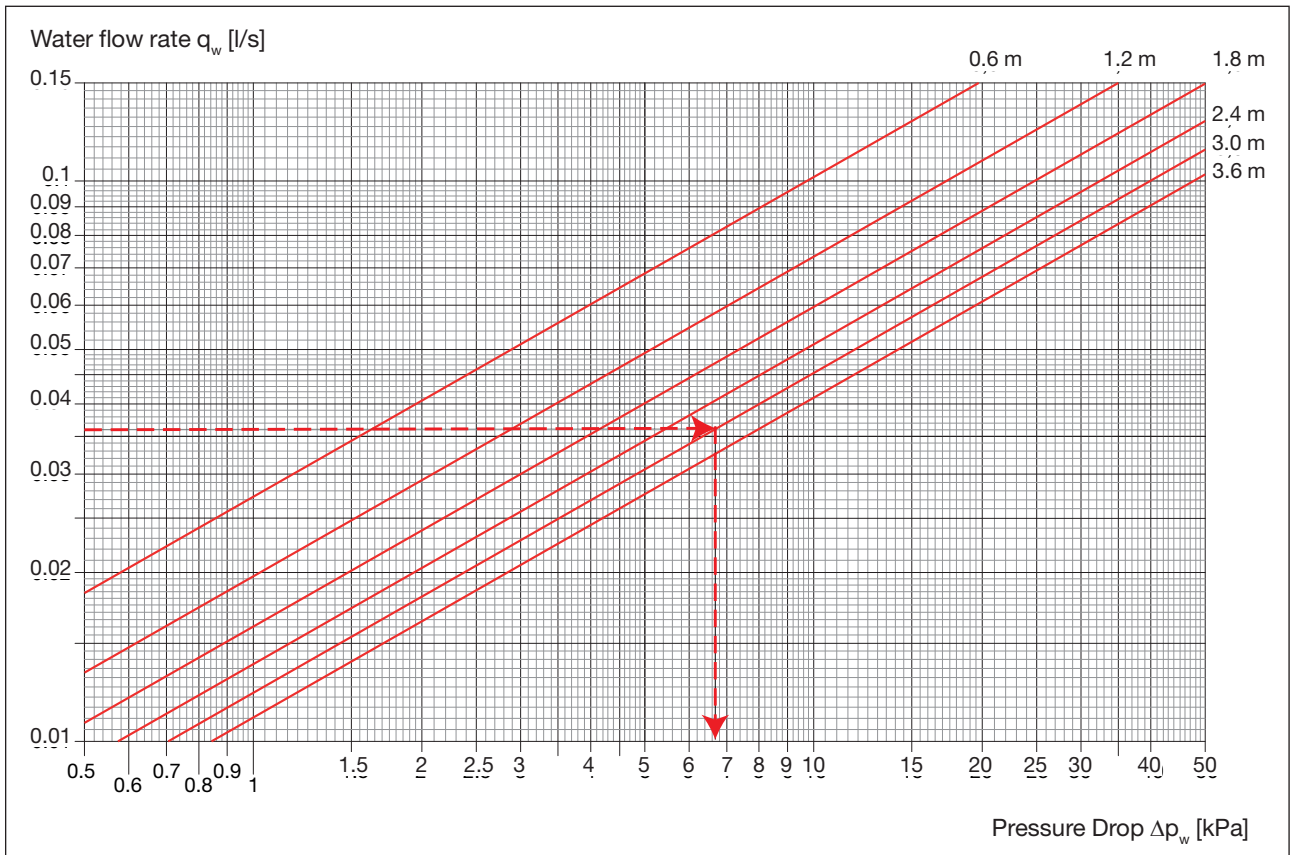

Diagram 4. Atrium Plana C-60/H-60, pressure drop at 60°C. For pressure drops at temperatures other than 60°C, the pressure drop is multiplied by the pressure drop factor (see diagram 5).

**Example 5:**

Atrium Plana H-60 3.0 m provides a capacity from:

$$P_w = 749 \text{ W at } \Delta t_w = 5 \text{ K}$$

$$t_{wio} = 0.5 \times (t_{wo} + t_{wi})$$

$$t_{wio} = 0.5 \times (60^\circ\text{C} + 55^\circ\text{C}) = 57.5^\circ\text{C}$$

$$q_w = P_w / (c_{pw} \times \Delta t_w)$$

$$q_w = 749 \text{ W} / (4200 \text{ Ws}/(\text{kg K}) \times 5 \text{ K}) = 0.036 \text{ l/s}$$

The pressure drop  $\Delta p_w$  in the water circuit is read off at 6.6 kPa from diagram 4.

Read off the pressure drop factor at  $t_{wio} = 57.5^\circ\text{C}$  from diagram 5. The value is 1.01.

Calculate the new pressure drop:

$$\Delta p_w = 6.6 \times 1.01 = 6.7 \text{ kPa.}$$

**Definitions:**

$q_w$  = Water flow rate [l/s]

$P_w$  = Cooling capacity water [W]

$c_{pw}$  = Specific heat capacity water [4200 Ws/(kg K)]

$\Delta t_w$  = Temperature difference water circuit [K]

$t_{wio}$  = Mean water temperature [°C]

$\Delta p_w$  = Pressure loss water circuit [kPa]

\* Diagrams are for a certain mean water temperature  $t_{wio}$ . For other temperatures please do your calculations in our waterborne calculator in [www.lindQST.com](http://www.lindQST.com)!

Multiplication factor		
Width	Heating	Cooling
C-40/H-40	0.5	0.5
C-60/H-60	1.0	1.0
C-90/H-90	1.5	1.5
C-120/H-120	2.0	2.0
HC-40	0.5	0.5
HC-60	1.0	1.0
HC-90	1.0	1.5
HC-120	1.0	2.0

Table 7. Multiplication factor pressure drop for others than C-60/H-60.

**NB!** Please use the multiplication factor from table 7 to calculate the pressure drop when using other than Atrium Plana C-60 or H-60.

# Heating and cooling panels Atrium Plana

## Pressure drop factor

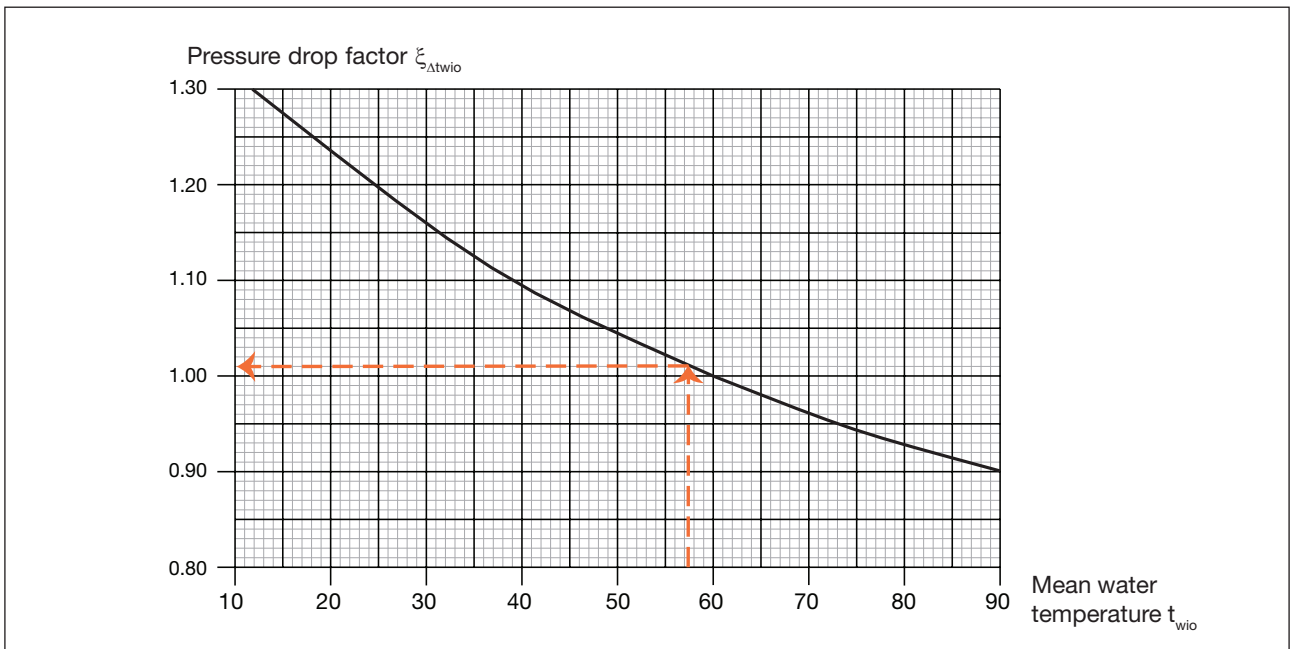
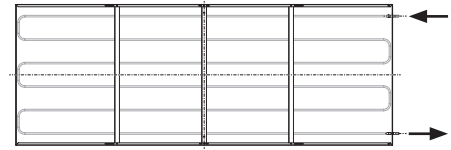

Diagram 5. Temperature adjusted pressure drop factor.

# Heating and cooling panels Atrium Plana

## Dimensions

### Heating or cooling 2-pipe water connection



**C1:**  
Connection type 1: Horizontal

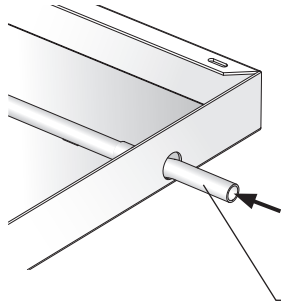

**C2:**  
Connection type 2: Vertical

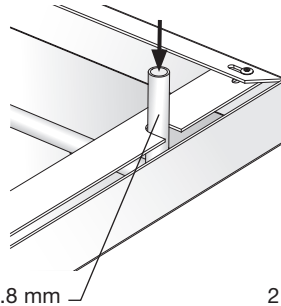

**C7:**  
Connection type 7: 15° bend

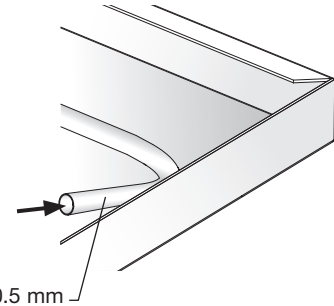

2 x CU-Ø10x0.8 mm

2 x CU-Ø10x0.5 mm

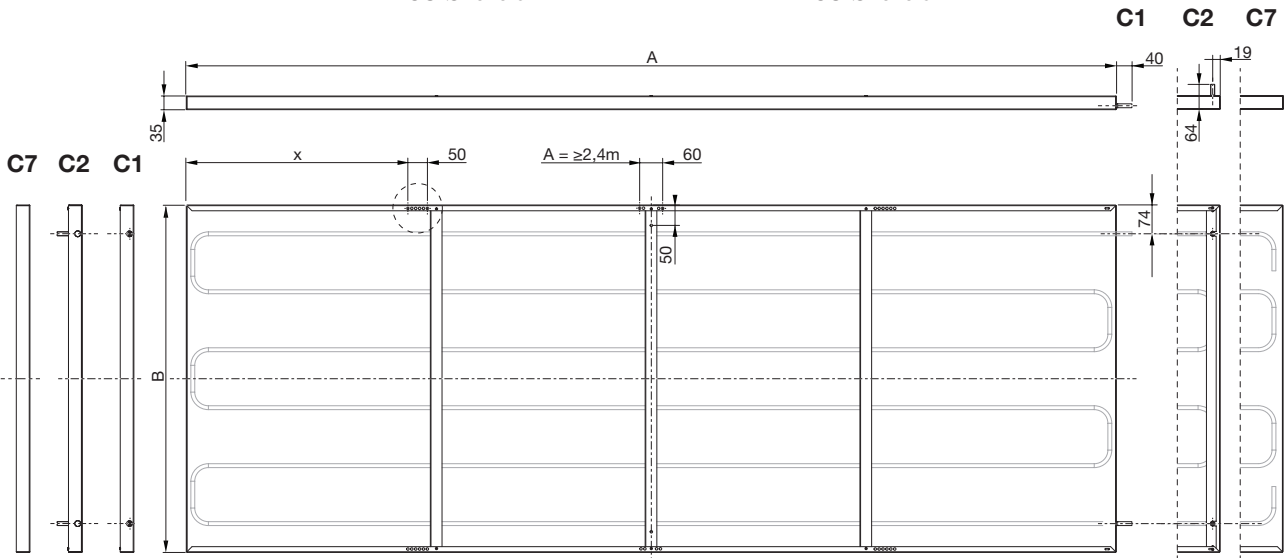

Dimensions of heating or cooling panel

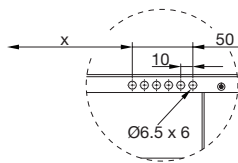

Preparation for installation of hangers  
(4 pcs if  $L_{nom} < 2.4$  m and 6 pcs if  $L_{nom} \geq 2.4$  m).

Type	B Width [ mm ]	Dry weight [ kg / m ]	Water content [ l / m ]	$L_{nom}$					
				600	1200	1800	2400	3000	3600
C-40 / H-40	392	2.1	0.4022	$A$ [ mm ]					
C-60 / H-60	592	3.0	0.8044						
C-90 / H-90	892	5.4	1.2066						
C-120 / H-120	1192	7.5	1.6088						
	x [ mm ]			119	269	419	204	204	204
	Expansion at *HW: + 55/45°C			0.7 mm/m					
	Expansion at *HW: + 80/60°C			1.2 mm/m					
	Copper pipes quality			EN 12735-2 CU-DHP					
	Pressure class			PN10					

Table 8. Type C-/H- cooling or heating panel, specific measures and other data - \*HW: Hot Water  
Tolerances for deflection: 2 mm deflection per 1 m off panel length/width.

# Heating and cooling panels Atrium Plana

## Dimensions

**Type HC- combined heating and cooling (4-pipe water connection).**

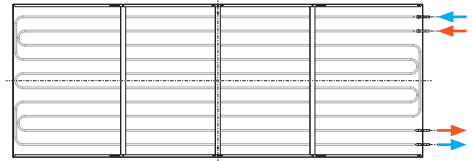

**C1:**  
Connection type 1: Horizontal

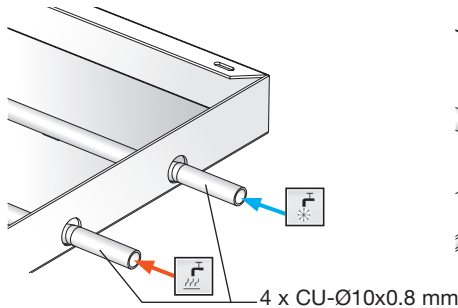

**C2:**  
Connection type 2: Vertical

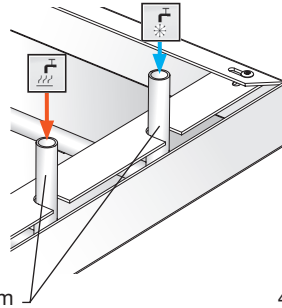

**C7:**  
Connection type 7: 15° bend

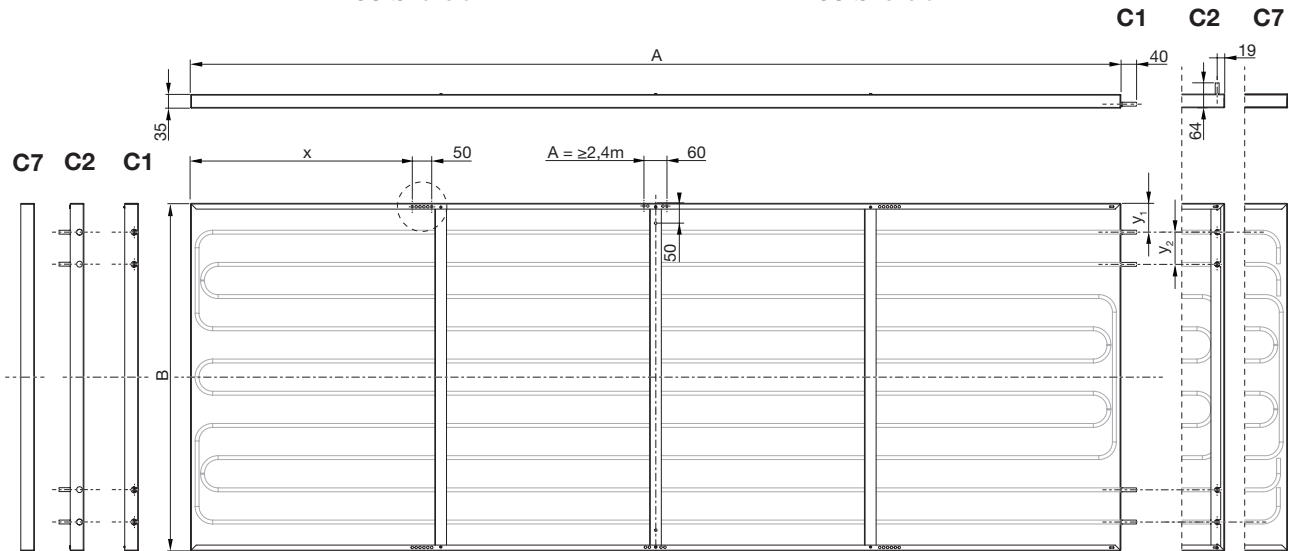
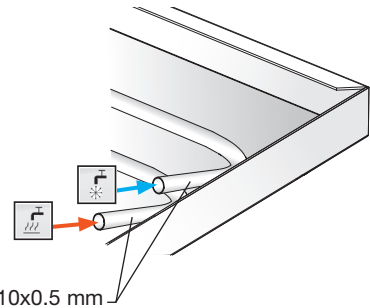

Dimensions of heating and cooling panel

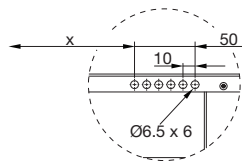

Preparation for installation of hangers  
(4 pcs if  $L_{nom} < 2.4$  m and 6 pcs if  $L_{nom} \geq 2.4$  m)

Type	B Width [ mm ]	Dry weight [ kg / m ]	Water content [ l / m ]	$y_1$	$y_2$	$L_{nom}$					
						600	1200	1800	2400	3000	3600
HC-40	392	2.2	0.844	74	81	<b>A [ mm ]</b>					
HC-60	592	3.2	1.6088	37	68						
HC-90	892	5.5	2.011	74	83						
HC-120	1192	7.6	2.4132	74	95						
	x					119	269	419	204	204	204
	Expansion at *HW: + 55/45°C					0.7 mm/m					
	Expansion at *HW: + 80/60°C					1.2 mm/m					
	Copper pipes quality					EN 12735-2 CU-DHP					
	Pressure class					PN10					

Table 9. Type HC- combined heating and cooling panel, specific measures and other data - \*HW: Hot Water. Tolerances for deflection: 2 mm deflection per 1 m off panel length/width.

# Heating and cooling panels Atrium Plana

## LindQST - just a click away

The Lindab Quick Selection Tool, **[lindQST®](#)**, is a very fast, easy-to-use and flexible online tool for your daily work.

[Calculate the Atrium Plana here](#)



Picture 3. LindQST - Indoor Climate Designer.

LindQST® helps you select the right waterborne products, e.g. active chilled beams, passive radiant chilled beams, radiant cooling- and heating panels and facade units and quickly finds the corresponding documentation.

In *Waterborne Documentation* you can easily find all available product documentation. Always in the latest version.

In *Waterborne Calculator* you can do a professional calculation based on your specific input data to finetune your choice or calculate different variants of the product. Smart warnings point out if a set-up will not work.

In *Waterborne Selector* you can compare the proposed products according to your specific requirements and select the one which fits best to your needs .

Not enough? With *Indoor Climate Designer* you can insert your selected waterborne product into your room and simulate the actual air distribution, optimize the placing in the ceiling taking into account the calculated air velocities and sound levels.

You can at anytime display your selection and calculations graphically. In addition, you can print or save all results and related documents for your documentation (incl. data sheets, dxf-files and room books).

With lindQST® you will easily find the most suitable product for your project.

It provides an easy and quick access to the latest product information, technical specifications and assembly instructions on the Internet, making it the ideal tool installers, consultants and architects alike.

[www.lindQST.com](http://www.lindQST.com)

- Fast product selection waterborne products in accordance to Eurovent (chilled beams and facade units).
- Easy access to all current documentation.
- Fast design of waterborne products.
- Indoor Climate Designer: Graphical representation of the spatial situation in 2D / 3D and floor plans from AutoCAD®.
- Calculation of capacities, sound power levels, pressure losses and flow conditions.
- 3D particles or smoke show the air distribution in the room.
- Diagram showing the time course of the CO<sub>2</sub> concentration in the room.
- Room book generation and data sheet for individual rooms and outlets or entire projects.
- Project can be saved and exchanged in its own project area.



# Heating and cooling panels Atrium Plana

## Control

Lindab offers control equipment that is very simple to use. To avoid heating and cooling being activated at the same time, the systems are controlled sequentially (Regula Combi). For the technical data, refer to a separate brochure, Regula.



## Programme text

Atrium Plana H is a flat heating panel with a sleek and soft design. H is made out of a thin aluminium plate with laser welded copper pipes on top and insulated with extruded polystyrene foam (manufactured without the addition of CFC or HCFC gas i. e. freons) to avoid heat radiation towards the ceiling.

Atrium Plana C is a flat cooling panel with a sleek and soft design. It is made out of a thin aluminium plate with laser welded copper pipes on top and powder coated to enable absorption of heat.

Atrium Plana HC is a flat combined heating and cooling panel with a sleek and soft design. It is made out of a thin aluminium plate with laser welded copper pipes on top and insulated with extruded polystyrene foam (manufactured without the addition of CFC or HCFC gas i. e. freons) to avoid heat radiation towards the ceiling.

Atrium Plana is available as standard in signal white RAL 9003 or in pure white RAL 9010 and can be installed recessed into the suspended ceiling, exposed free hanging or exposed sealed directly to the ceiling. Lindab's radiant panels are tested according to EN-14037/EN-14240 and are CE-marked.

Add optional: ...with perforation slot M6 (-1), full M6 (-2), slot U8(-3) or full U8(-4) ...for increased sound attenuation in the room with sound-absorbing insulation material on the top (special feature).

## Technical Data (Example)\*:

Manufacturer:	Lindab
Product:	Atrium Plana
Type:	H-120-10-1-3.6m-0
Panel length:	3588 mm
Panel width:	592 mm
Panel height:	35 mm
Connection type:	1
Colour:	RAL 9003 or RAL 9010, gloss value 5 ± 1
Amount:	2 pieces
Water temperatures in/out:	55 / 45°C
Room temperature:	21°C
Water connection:	10 mm
Water flow rate:	0.030 l/s
Pipe pressure drop loss:	12.1 kPa
Heating capacity/panel:	1260 W

\*For correct update of your programme text find "[Waterborne Calculator](#)" on [www.lindQST.com](http://www.lindQST.com).

## Order code

Product	Atrium Plana C	120	10	1	3.6m	0
Type: C, H, HC						
Width: 40, 60, 90 and 120 cm						
Water connection: 10 mm						
Connection type: 1, 2, 7						
Length: 0.6 – 1.2 – 1.8 – 2.4 – 3.0 – 3.6 m						
Perforation:						
0 = no (std.)						
1 = slot M6						
2 = full M6						
3 = slot U8						
4 = full U8						



Most of us spend the majority of our time indoors. Indoor climate is crucial to how we feel, how productive we are and if we stay healthy.

We at Lindab have therefore made it our most important objective to contribute to an indoor climate that improves people's lives. We do this by developing energy-efficient ventilation solutions and durable building products. We also aim to contribute to a better climate for our planet by working in a way that is sustainable for both people and the environment.

[Lindab](#) | For a better climate