

Shut-off damper

DTU



Description

Has a turning circular blade with an EPDM-rubber seal which tightens against the inside of the damper when closed. The blade can be adjusted in a 0–90° angle.

The cup at Ø 80–630 can be complemented with the special insulation cup IK at insulation thicker than 50 mm.

The damper can be used for regulating at rare occasions.

There is a separate assembly, measuring, balancing and maintenance instruction for this product.

Ø 80–315 fullfills pressure class C in closed position.
 Ø 355–630 fullfills pressure class B in closed position.
 Ø 710–1000 fullfills pressure class A in closed position.

Motorizing

The torque needed for the motorizing is given in the adjacent table.

Ø710–1000 is not possible to motorize on site.

Reinforced blade



Ordering example

Product **DTU** **200**
 Dimension Ød₁

Dimensions

Ø 80–630

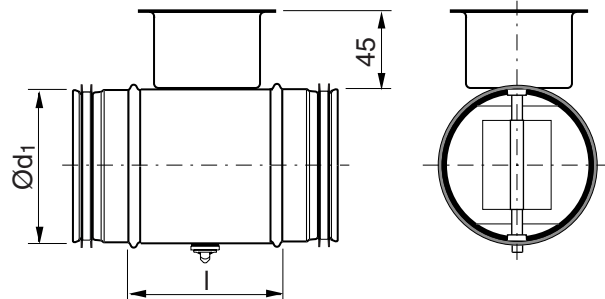

Ø 800–1000

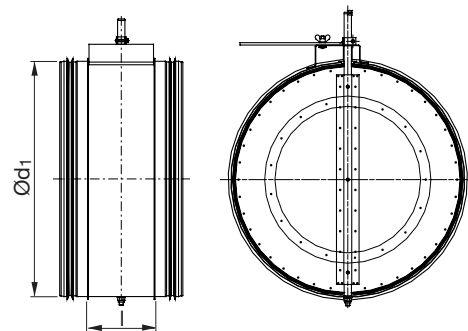

Ød ₁ nom	l [mm]	M Nm	m [kg]	Sealing class past closed blade
80	100	2,0	0,30	4
100	100	2,0	0,38	4
112	100	2,0	0,48	4
125	100	2,0	0,53	4
140	100	2,0	0,60	4
150	100	2,0	0,63	4
160	100	2,0	0,74	4
180	100	2,0	0,82	4
200	100	2,0	1,04	4
224	100	3,0	1,27	4
250	100	3,0	1,52	4
280	100	4,0	1,77	4
300	100	4,0	1,98	4
315	100	4,0	2,14	4
355	100	8,0	2,44	4
400	100	8,0	3,65	4
450	100	10	4,84	4
500	115	10	6,07	4
560	115	15	7,47	4
600	115	15	8,11	4
630	115	15	8,80	4
710	230	40	17,0	4
800	230	40	19,5	4
900	230	60	26,0	4
1000	230	60	31,0	4



Shut-off damper

DTU

Property	Ø 80-315	Ø 400	Ø 500	Ø 630	Ø 710-1000
The blade is set via a knob in a protective cup.	x	x	x	x	
The setting of the blade is read against an embossed scale at the rim of the cup.	x	x	x	x	
The blade is locked with two screws, type Pozidriv (PZD2).	x	x	x	x	
The blade has reinforced locking with a sturdy wing nut.					x
The blade is reinforced.		x	x	x	
The blade is additionally reinforced.					x
With sturdy handle.		x	x	x	
With additionally reinforced handle.					x
With reinforced stop beads.			x	x	x
The axle is reinforced.					x
The damper can be delivered prepared for motor. Is then called DTHU.	x	x	x	x	x
The damper can be delivered with electric motor of On/Off-type without spring return. Is then called DTBU.	x	x	x	x	x
The damper can be delivered with electric motor of On/Off-type with spring return. Is then called DTBCU.	x	x	x	x	
The damper can be delivered with pneumatic actuator of On/Off-type with spring return. Is then called DTPU.	x	x	x	x	

Technical data

Pressure drop graphs with noise data for dimensioning

The solid curves show the pressure drop, Δp_t , over the damper as a function of flow q , and setting angle α .

The dashed curves give the A-weighted sound power data, L_{WA} , in dB to the duct.

Example

Given Dimension Ø100
 Flow 60 l/s
 Pressure drop 200 Pa

Obtained from graph

Setting angle 32°
 Sound power level 63 dB (A)

Ø80

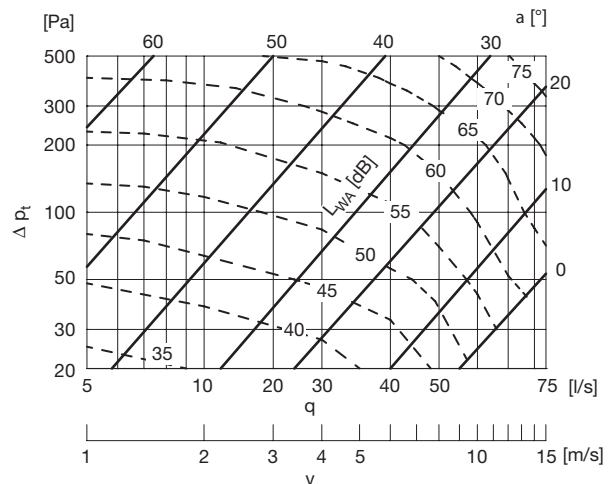

Ø100

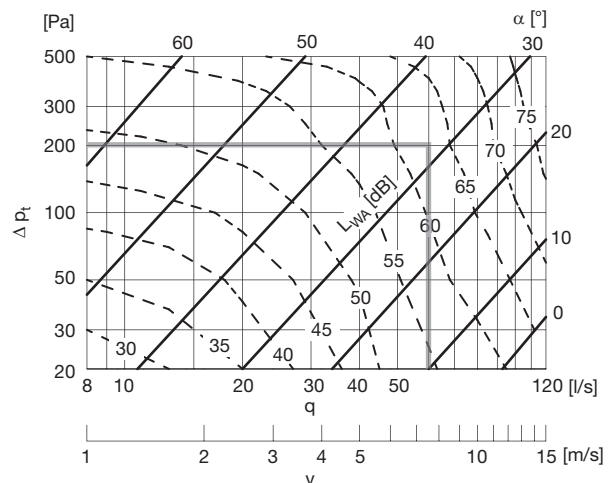

Shut-off damper

DTU

Ø112

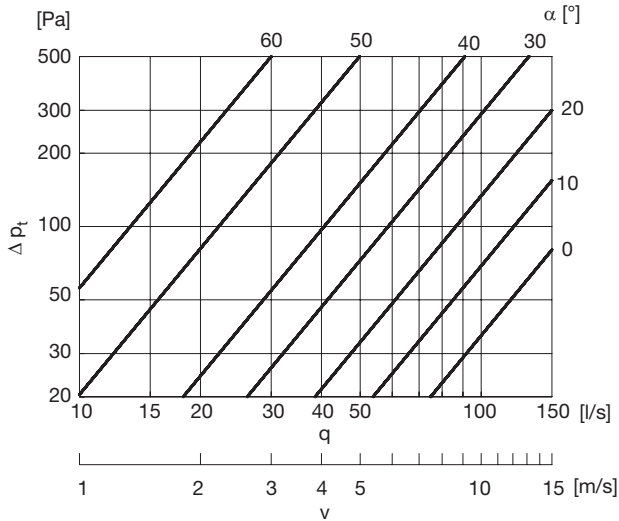

Ø150

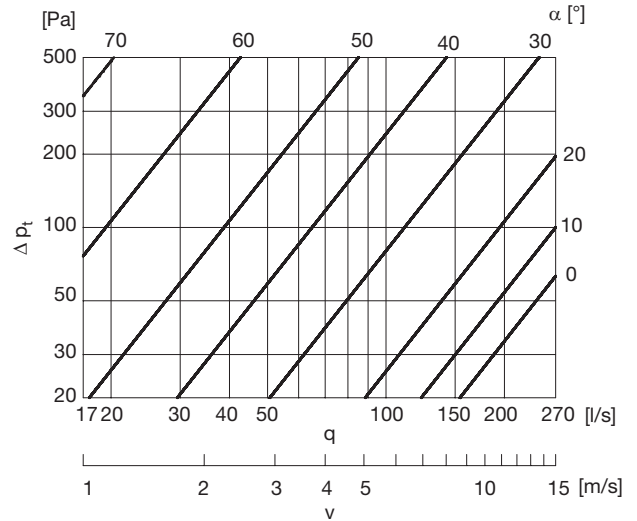

Ø125

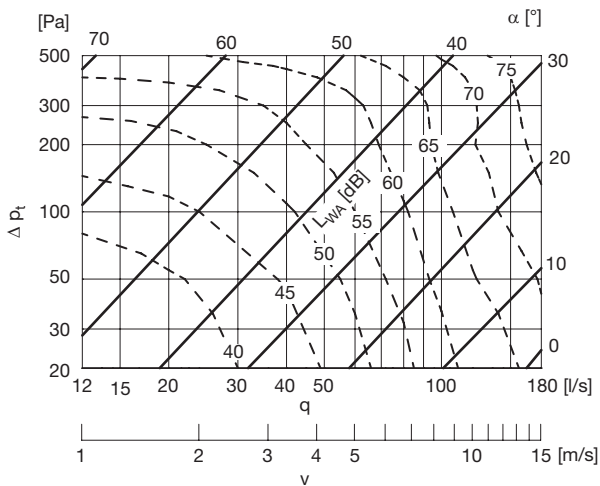

Ø160

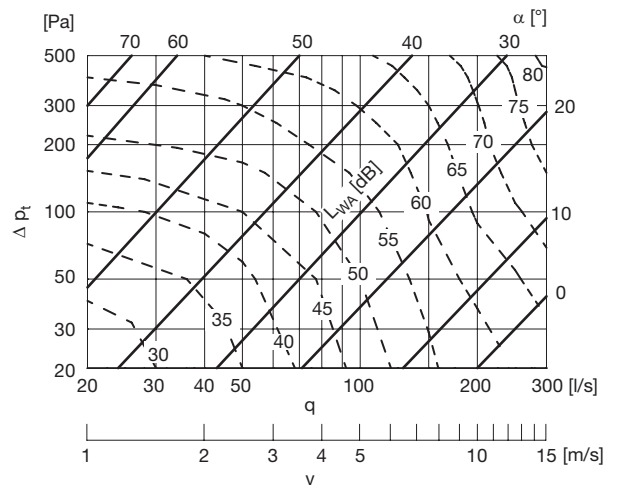

Ø140

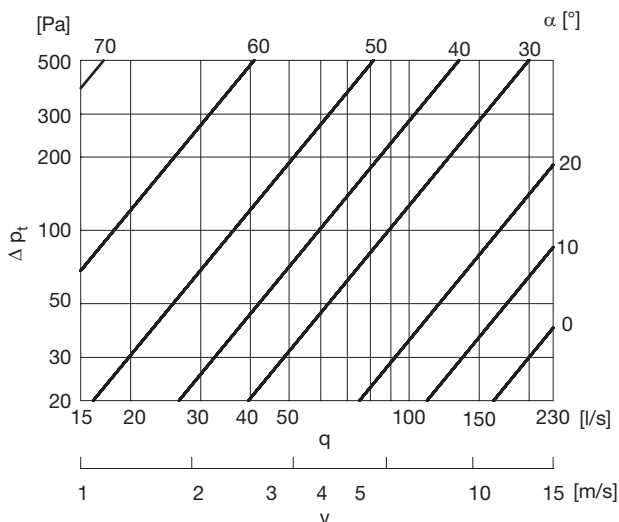

Ø180

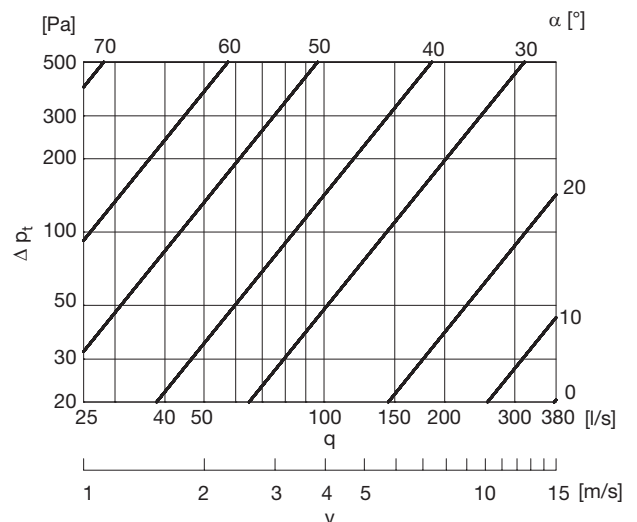

Shut-off damper

DTU

Ø200

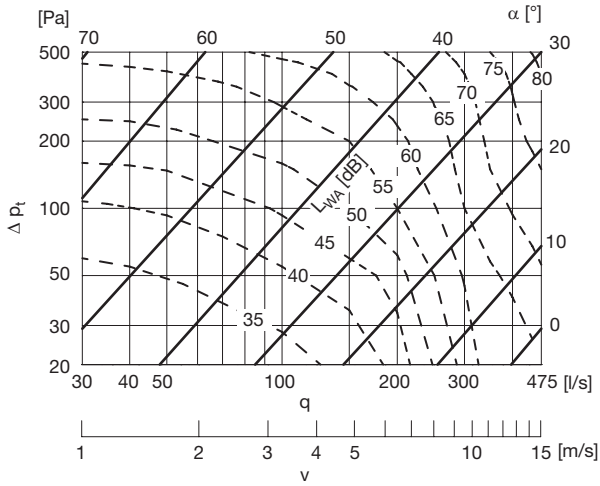

Ø280

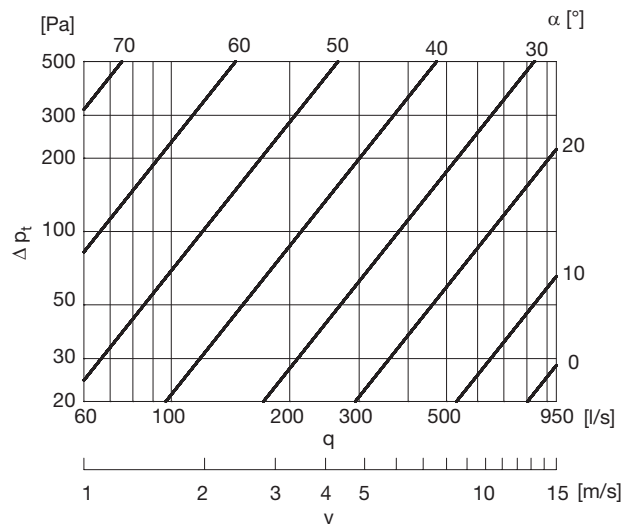

Ø224

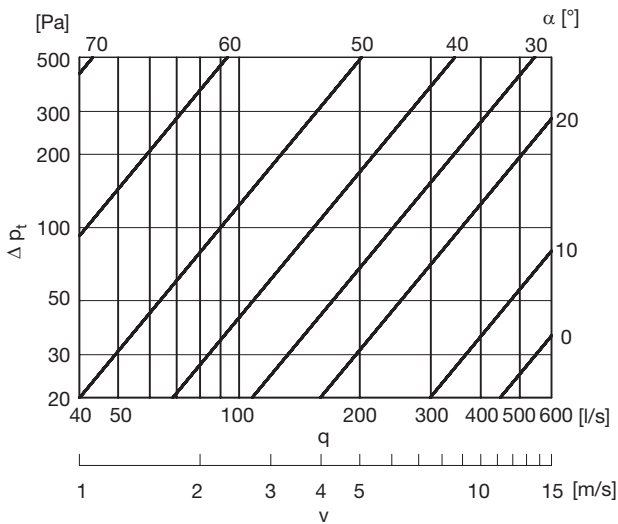

Ø300

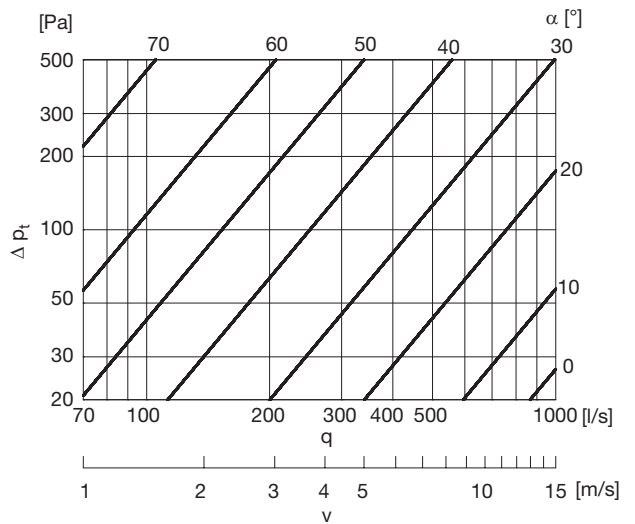

Ø250

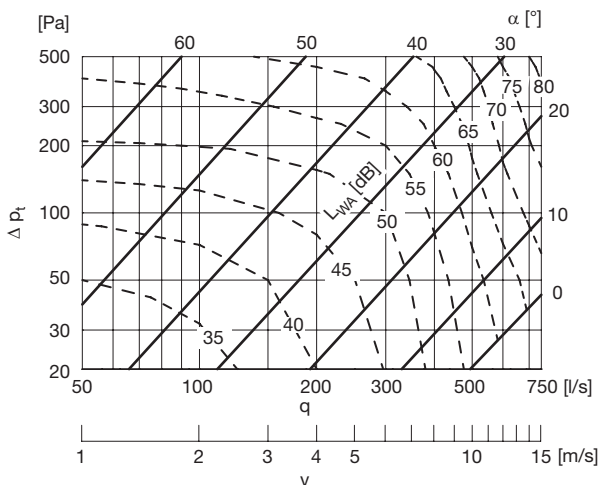

Ø315

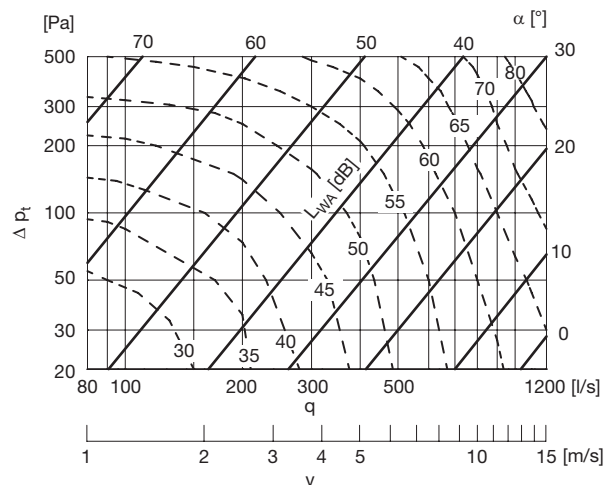

Shut-off damper

DTU

Ø355

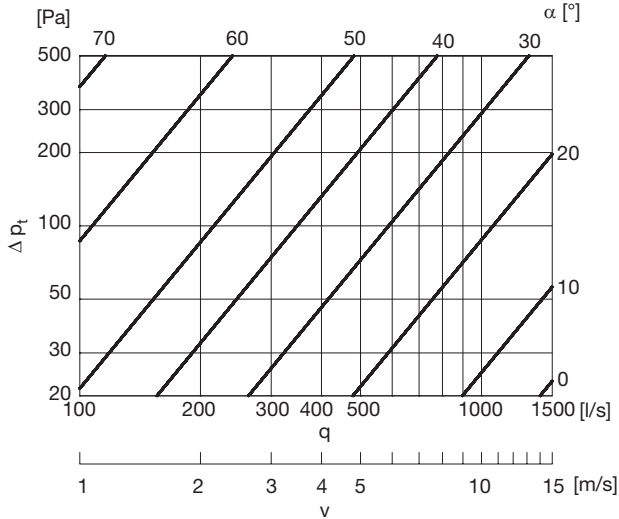

Ø400

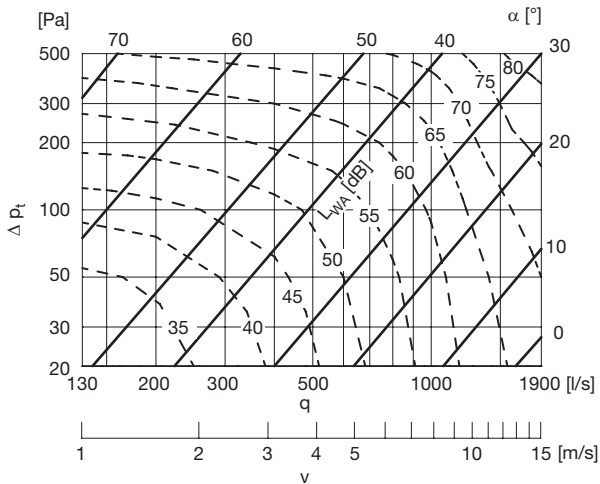

Ø450

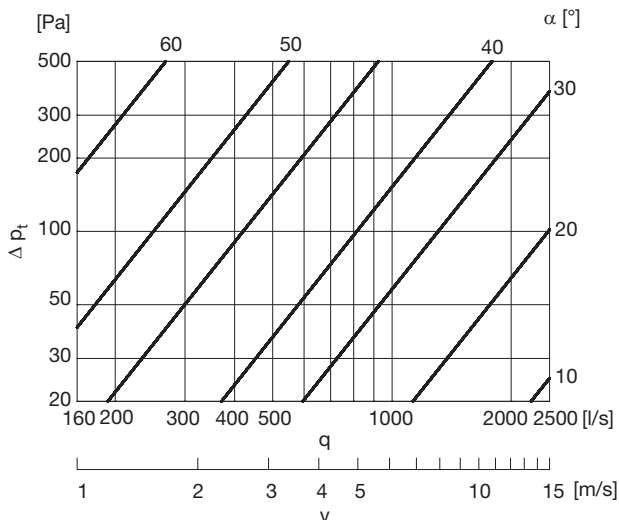

Ø500

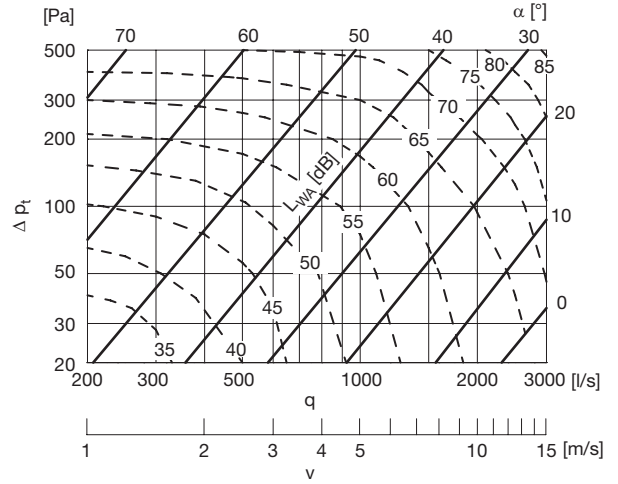

Ø560

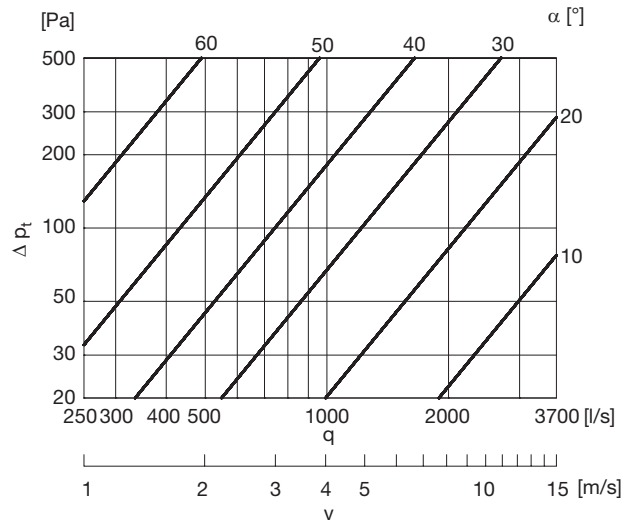

Ø600

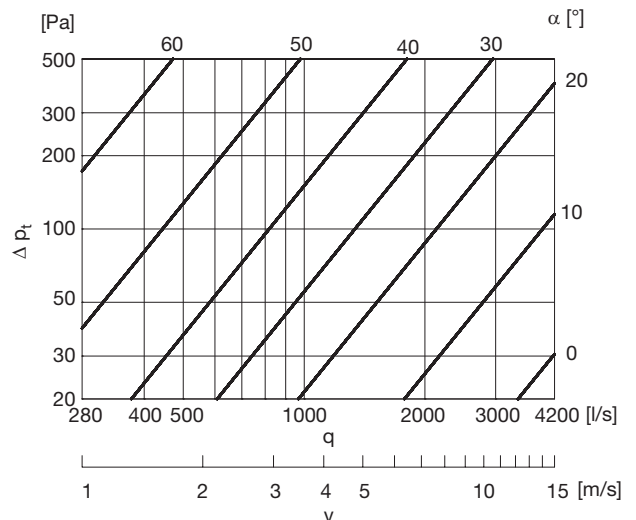

Shut-off damper

DTU

Ø630

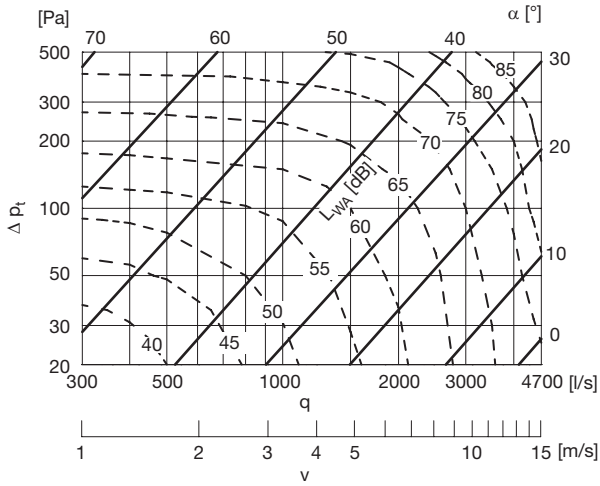

Ø900

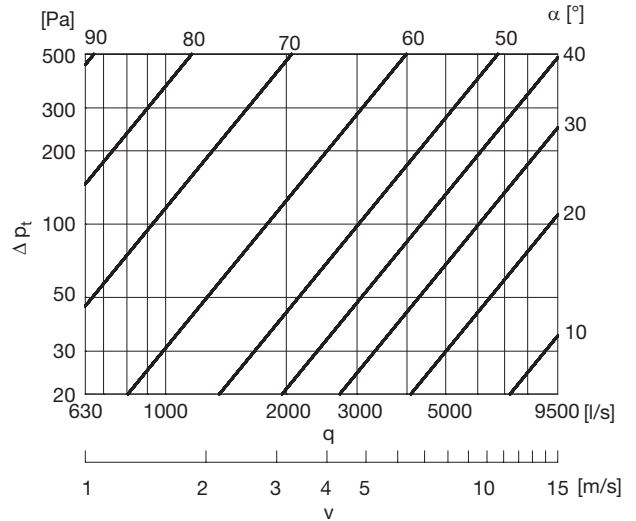

Ø710

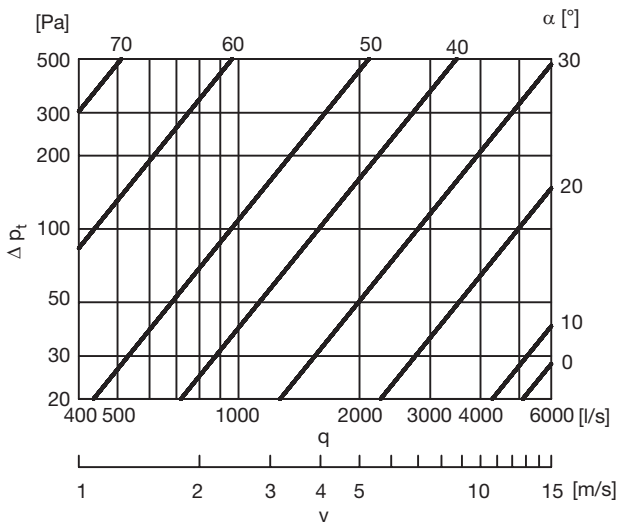

Ø1000

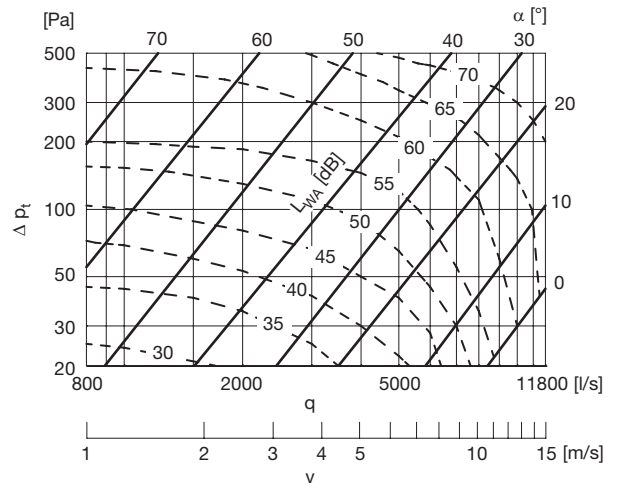

Ø800

