

# UltraLink® Controller

# FTCU



## Description

### Application

The Controller is suitable for measuring and controlling air flow and measuring temperature. Communication is established via analog signals and/or digital signal using Modbus.

The Controller can also be commissioned via Bluetooth.

The OneLink app is the perfect tool to monitor and adjust the airflow directly via a mobile device, which speeds up installation and commissioning.

### Design

The Controller consists of a sensor body attached to a damper body with Lindab Safe gaskets.

Two transducers are mounted on the sensor body and connected to a display unit. The display unit is mounted on top of a shelf on the damper body.

The product has a pre-mounted cable which makes it easy to connect.

The shelf, FTES, can be used for mounting equipment such as an electrical junction box or a Regula Combi.

### Maintenance

Normally does not require any maintenance.

The visible parts of the device can be wiped with a damp cloth.

## Ordering example

Product	FTCU	200	4
Dimension Ød <sub>1</sub>			
Type			

## Dimensions

### FTCU 100-315

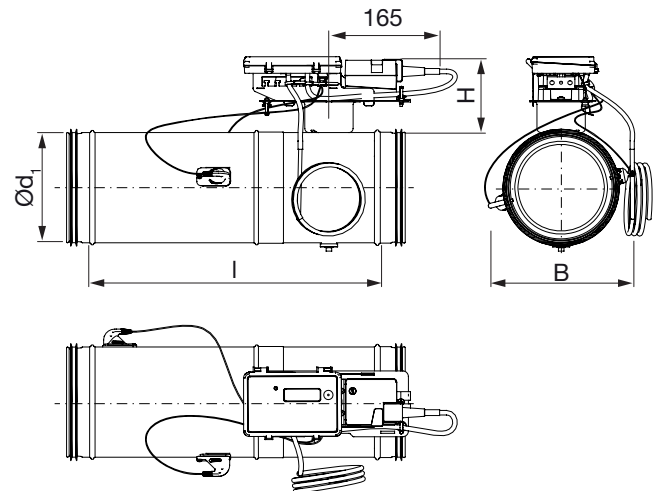

### FTCU 400-630

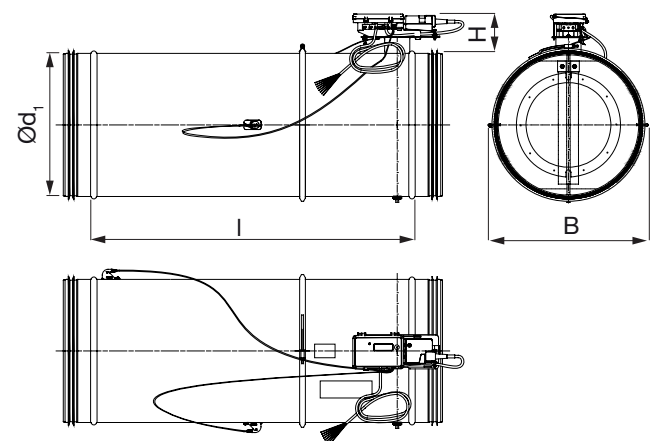

Ød <sub>1</sub> nom	l mm	H mm	B mm	m kg
100	321	108	160	1,67
125	345	108	185	1,94
160	423	108	220	2,46
200	493	108	260	3,33
250	590	108	310	4,65
315	720	108	375	6,36
400	901	108	470	10,6
500	1120	108	570	20,8
630	1372	108	700	30,4

## Special versions

We can supply UltraLink with the following special designs (Ø 100 – 315):

- White (RAL 9003)
- Black (RAL 9005)
- Stainless steel 4404 (acid-proof)



# UltraLink® Controller

# FTCU

## Factory settings

	Default		On request	
	Value	Parameter	Value	Parameter
Min. flow velocity [m/s]	0		0,7	
Max. flow velocity v(nom) [m/s]	7		10 or 15	
Analog in range [V]	2-10	Flow	0-10	Flow
Analog out 1 range [V]	2-10	Flow	0-10	Flow
Analog out 2 range [V]	2-10	Damper pos.	0-10	Damper pos.
			2-10	Temp.
			0-10	Temp.

## Wiring

For wiring with premounted cable:

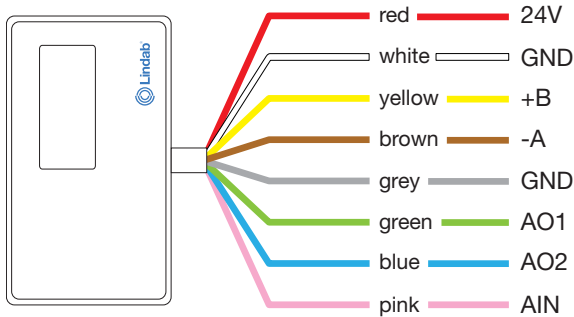

- Red**            **24V**, power supply (AC G, DC +) \*
- White**        **GND**, power supply (AC G0, DC -) \*
- Yellow**       **+B**, connection for Modbus via RS485
- Brown**        **-A**, connection for Modbus via RS485
- Grey**          **GND**, ground (system neutral)
- Green**        **AO1**, analog output
- Blue**          **AO2**, analog output
- Pink**          **AIN**, analog input

\*) When using AC terminal 1 (G) should have system potential and terminal 2 (G0) should be system neutral.

## UltraLink® Controller

## FTCU

## Technical data

Power supply	AC/DC	24 (19-28)	V
Cable	Max outer diameter	7	mm
Power consumption	Dim. 100–315	2	W
	Dim. 400–630	3	W
Power consumption	For wiring dim. 100–315	3	VA
	For wiring dim. 400–630	5	VA
Premounted cable	Length	0,7	m
Degree of protection	EN 60529	IP44	
Tightness class to the environment	EN 12237	D	
Tightness class, past a closed damper	EN 1751	4	
Pressure class, $\Delta p$ closed damper	Dim. 100–315	C (max. 5000 Pa)	
	Dim. 400–630	B (max. 2500 Pa)	
Storage temperature range		-30 to +50	°C
Maximum ambient moisture		95	% RH
Connection	RS485 standard or analog		
Cable	RS485 standard cable, 2-wire shielded twisted pair, min. 0,1 mm <sup>2</sup> (LIYCY cable)		
Protocol	Modbus		
Output	Flow		m <sup>3</sup> /h
	Flow		l/s
	Velocity		m/s
	Temperature		°C
	Damper position (0% fully closed, 100% fully open)		%
Velocity range	For guaranteed measurement uncertainty	0,2 - 15	m/s
Measurement uncertainty flow (assuming correct installation)	Depending on which is the greatest of the percentage or the absolute number for the specific products size.	±5	% or
		Dim. 100 = ±1,00	l/s
		Dim. 125 = ±1,25	l/s
		Dim. 160 = ±1,60	l/s
		Dim. 200 = ±2,00	l/s
		Dim. 250 = ±2,50	l/s
		Dim. 315 = ±3,15	l/s
		Dim. 400 = ±4,00	l/s
	Dim. 500 = ±5,00	l/s	
	Dim. 630 = ±6,30	l/s	
Temperature range		-10 to +50	°C
Measurement uncertainty temperature		±1	°C
Bluetooth signal	Frequency	2402–2480	MHz
	Output power	-40 to +9	dB



# UltraLink® Controller

# FTCU

## Technical data

### Pressure drop graphs with noise data to ducts for dimensioning

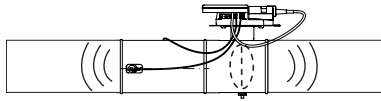

The solid curves show the pressure drop,  $\Delta p_t$ , over the damper as a function of flow  $q$ , and setting angle  $\alpha$ .

The dashed curves give the A-weighted sound power data,  $L_{WA}$ , in dB to the duct. These curves are intended for brief comparison. For more accurate calculation, please use the tables.

Setting angle °

$\alpha = 0^\circ =$  open blade

$\alpha = 90^\circ =$  closed blade

Setting angel %

$\alpha = 100\% =$  open blade

$\alpha = 0\% =$  closed blade

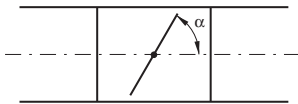

### Example

Given	Dimension	Ø100
	Flow	50 l/s
	Pressure drop	100 Pa

Obtained from graph

Setting angle	39°
Sound power level	57,7 dB (A)

### Ø100

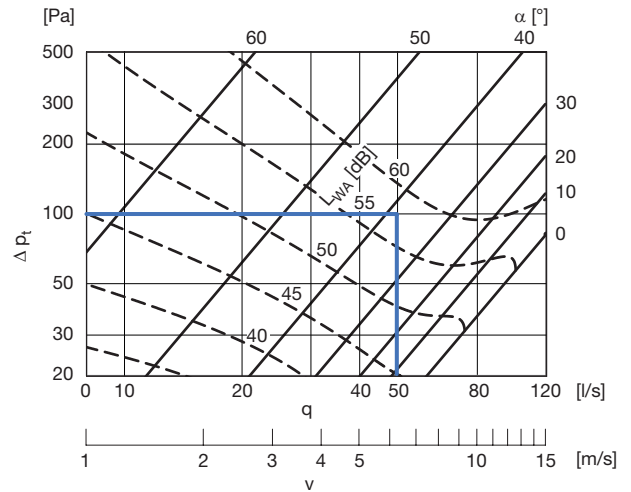

### Ø125

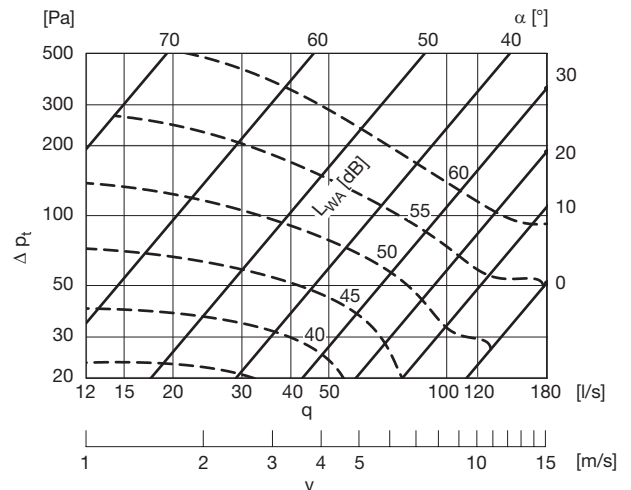

### Ø160

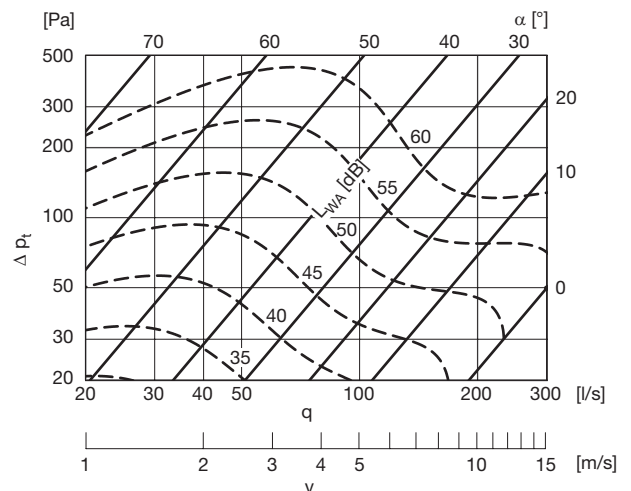

# UltraLink® Controller

# FTCU

## Ø200

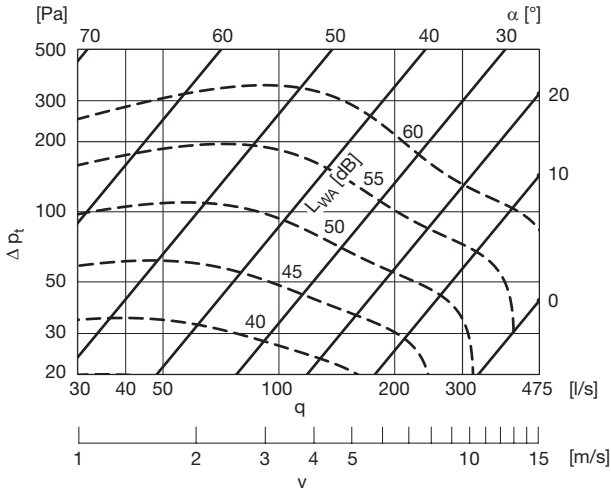

## Ø400

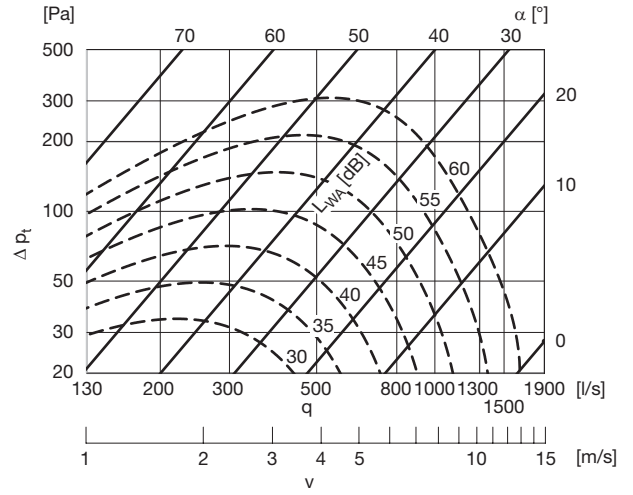

## Ø250

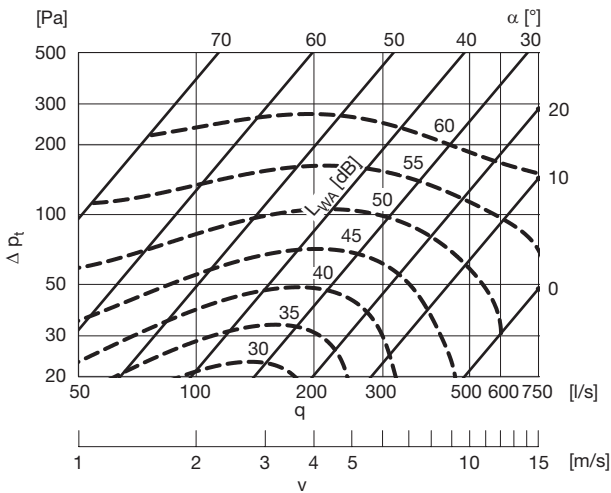

## Ø500

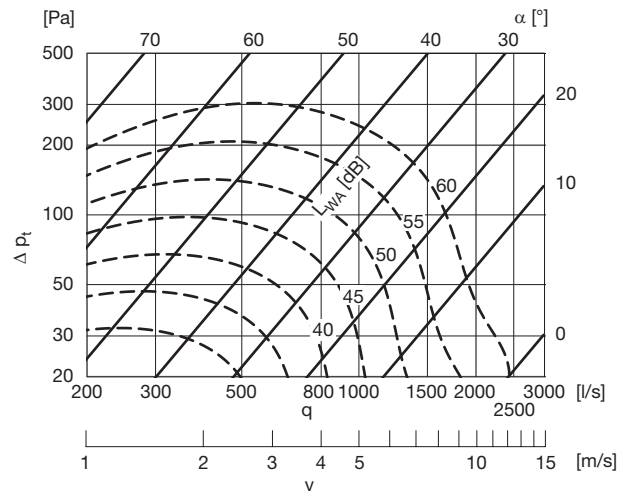

## Ø315

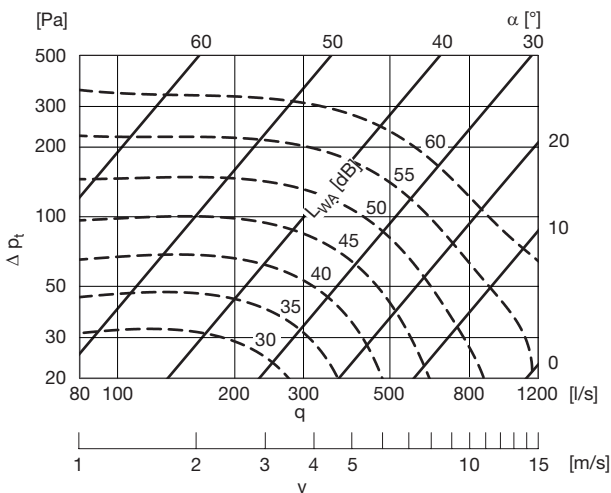

## Ø630

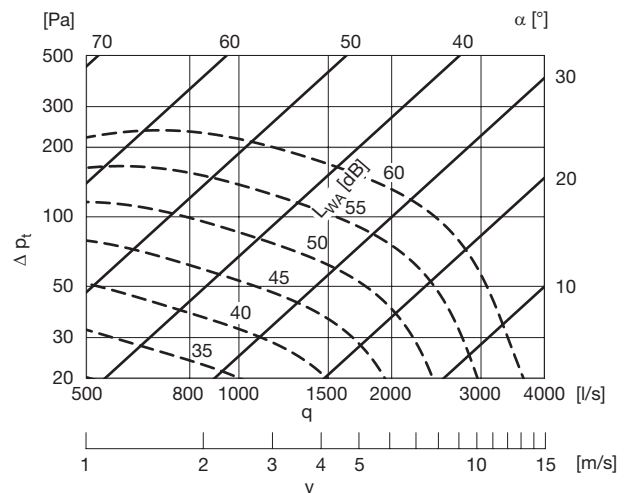

# UltraLink® Controller

# FTCU

## Sound data

Sound power level  $L_{W}$ , [dB] to duct in the octave bands 1–8, 63–8000 Hz, as a function of dimension, flow and pressure drop.  
 Note: A-filter have to be applied to the figures in the table if  $L_w(A)$  is to be calculated.

### A-filter correction.

63	125	250	500	1K	2K	4K	8K
-26	-16	-9	-3	0	1	1	-1

dim $\varnothing d_1$	Pressure loss [Pa]	Centre frequency [Hz]								Centre frequency [Hz]								Centre frequency [Hz]							
		63	125	250	500	1k	2k	4k	8k	63	125	250	500	1k	2k	4k	8k	63	125	250	500	1k	2k	4k	8k
100		Velocity app. 1 [m/s]								Velocity app. 3 [m/s]								Velocity app. 6 [m/s]							
		Flow 8 [l/s]								Flow 24 [l/s]								Flow 47 [l/s]							
	500	71	47	44	48	50	48	42	31	74	55	57	59	58	54	46	36	77	66	68	67	63	57	49	38
	200	65	44	42	45	45	42	37	28	68	55	55	55	52	46	40	31	70	66	66	61	55	48	40	32
	100	60	42	40	41	41	37	32	24	62	54	53	50	46	40	34	27	65	64	62	55	48	41	33	26
	50	55	40	38	37	35	32	27	21	57	51	49	45	39	33	28	22	61	60	57	49	42	35	27	21
	20	47	36	33	30	27	23	19	15	51	47	43	36	29	25	19	15	61	49	47	44	38	32	24	17
		Velocity app. 9 [m/s]								Velocity app. 12 [m/s]								Velocity app. 15 [m/s]							
		Flow 71 [l/s]								Flow 94 [l/s]								Flow 118 [l/s]							
	500	78	75	76	72	65	58	49	39	80	81	81	75	66	58	48	38	81	85	84	76	67	58	47	37
200	72	73	72	65	56	48	39	31	75	76	74	66	57	49	39	30	77	75	74	67	59	50	40	29	
100	69	68	66	58	50	43	33	25	73	65	64	59	52	45	35	25	75	60	61	58	51	44	35	24	
50	68	57	56	52	46	39	30	21	-	-	-	-	-	-	-	-	-	-	-	-	-	-	-	-	
20	-	-	-	-	-	-	-	-	-	-	-	-	-	-	-	-	-	-	-	-	-	-	-	-	

dim $\varnothing d_1$	Pressure loss [Pa]	Centre frequency [Hz]								Centre frequency [Hz]								Centre frequency [Hz]							
		63	125	250	500	1k	2k	4k	8k	63	125	250	500	1k	2k	4k	8k	63	125	250	500	1k	2k	4k	8k
125		Velocity app. 1 [m/s]								Velocity app. 3 [m/s]								Velocity app. 6 [m/s]							
		Flow 12 [l/s]								Flow 37 [l/s]								Flow 74 [l/s]							
	500	79	61	48	48	53	54	49	38	77	56	55	58	58	55	51	43	80	68	67	66	61	55	49	41
	200	70	50	43	45	47	47	44	35	71	56	54	54	51	46	42	36	73	67	65	59	52	44	36	31
	100	64	45	41	42	42	41	38	31	65	55	52	49	44	39	34	29	67	64	60	52	44	37	29	24
	50	58	41	38	38	37	34	32	27	59	52	48	42	36	30	25	21	63	58	54	47	40	34	26	20
	20	50	37	34	31	27	24	21	18	51	46	40	33	27	22	16	13	59	48	45	42	39	35	29	20
		Velocity app. 9 [m/s]								Velocity app. 12 [m/s]								Velocity app. 15 [m/s]							
		Flow 110 [l/s]								Flow 147 [l/s]								Flow 184 [l/s]							
	500	82	76	75	69	62	54	45	38	83	82	79	71	62	53	42	35	85	85	81	73	63	54	42	34
200	75	73	69	61	53	45	35	28	77	75	71	64	56	49	38	29	79	74	71	66	61	55	44	31	
100	70	67	63	56	49	43	33	25	73	65	62	59	55	50	41	28	75	62	61	59	56	52	43	30	
50	67	57	55	51	48	44	36	24	71	57	56	52	49	45	37	26	-	-	-	-	-	-	-	-	
20	66	53	50	45	40	36	29	20	-	-	-	-	-	-	-	-	-	-	-	-	-	-	-	-	

dim $\varnothing d_1$	Pressure loss [Pa]	Centre frequency [Hz]								Centre frequency [Hz]								Centre frequency [Hz]							
		63	125	250	500	1k	2k	4k	8k	63	125	250	500	1k	2k	4k	8k	63	125	250	500	1k	2k	4k	8k
160		Velocity app. 1 [m/s]								Velocity app. 3 [m/s]								Velocity app. 6 [m/s]							
		Flow 20 [l/s]								Flow 60 [l/s]								Flow 121 [l/s]							
	500	83	61	53	54	60	66	67	57	68	53	54	56	56	55	53	45	69	61	63	62	58	55	51	43
	200	68	50	47	49	51	53	52	44	60	50	51	50	47	45	42	36	65	60	61	58	53	48	42	34
	100	59	43	41	42	43	43	41	35	56	48	48	45	42	39	35	29	63	57	58	54	48	42	34	26
	50	51	38	36	35	34	33	31	27	53	46	45	41	36	33	28	23	60	52	52	49	43	36	27	20
	20	42	32	29	26	23	21	20	17	49	41	39	35	30	25	19	15	58	44	44	41	35	29	21	15
		Velocity app. 9 [m/s]								Velocity app. 12 [m/s]								Velocity app. 15 [m/s]							
		Flow 181 [l/s]								Flow 241 [l/s]								Flow 302 [l/s]							
	500	73	68	71	68	62	58	51	41	76	73	76	72	66	59	50	39	78	75	78	75	68	59	48	36
200	70	65	67	63	57	50	40	31	73	66	68	66	59	50	38	28	75	65	68	66	59	50	37	26	
100	67	59	60	57	51	43	32	23	70	58	60	58	51	43	32	22	74	58	59	57	51	43	33	23	
50	65	52	53	50	44	37	27	19	71	53	54	51	45	39	31	22	-	-	-	-	-	-	-	-	
20	67	49	48	45	39	34	27	20	-	-	-	-	-	-	-	-	-	-	-	-	-	-	-	-	





# UltraLink® Controller

# FTCU

dim Ød <sub>1</sub>	Pressure loss [Pa]	Centre frequency [Hz]								Centre frequency [Hz]								Centre frequency [Hz]								
		63	125	250	500	1k	2k	4k	8k	63	125	250	500	1k	2k	4k	8k	63	125	250	500	1k	2k	4k	8k	
500		Velocity app. 1 [m/s]								Velocity app. 3 [m/s]								Velocity app. 6 [m/s]								
		Flow 196 [l/s]								Flow 589 [l/s]								Flow 1178 [l/s]								
	500	-	-	-	-	-	-	-	-	55	53	57	61	63	61	53	40	67	64	65	66	65	60	50	37	
	200	47	41	47	53	56	56	50	37	55	50	51	52	51	48	40	29	69	62	59	58	55	50	41	32	
	100	43	38	40	43	44	43	38	28	54	48	45	44	42	38	31	23	70	60	55	52	48	43	36	31	
	50	40	34	33	33	32	30	26	19	53	44	40	37	34	30	24	19	71	59	52	47	42	38	34	31	
	20	-	-	-	-	-	-	-	-	51	41	34	30	26	22	19	17	71	58	48	41	36	32	31	32	
			Velocity app. 9 [m/s]								Velocity app. 12 [m/s]								Velocity app. 15 [m/s]							
			Flow 1767 [l/s]								Flow 2356 [l/s]								Flow 2945 [l/s]							
	500	78	72	71	71	69	62	51	39	87	79	76	74	71	64	54	44	95	85	80	77	73	66	57	49	
	200	81	71	66	63	59	53	45	39	90	79	71	66	62	56	50	46	97	84	75	68	62	57	53	51	
	100	82	70	63	57	53	48	43	40	91	77	67	60	54	50	47	47	96	81	69	60	54	49	48	50	
50	83	69	59	52	46	42	40	41	89	75	62	53	46	42	42	45	92	78	64	53	45	41	41	46		
20	80	66	53	44	37	33	33	37	85	71	57	46	38	34	34	39	-	-	-	-	-	-	-	-		

dim Ød <sub>1</sub>	Pressure loss [Pa]	Centre frequency [Hz]								Centre frequency [Hz]								Centre frequency [Hz]								
		63	125	250	500	1k	2k	4k	8k	63	125	250	500	1k	2k	4k	8k	63	125	250	500	1k	2k	4k	8k	
630		Velocity app. 1 [m/s]								Velocity app. 3 [m/s]								Velocity app. 6 [m/s]								
		Flow 312 [l/s]								Flow 935 [l/s]								Flow 1870 [l/s]								
	500	-	-	-	-	-	-	-	-	61	56	61	67	68	63	53	41	64	62	68	71	70	63	52	40	
	200	53	44	51	59	62	58	47	34	55	51	54	56	55	50	41	32	61	57	61	62	60	53	42	32	
	100	48	41	42	46	46	43	35	27	52	47	49	49	47	42	34	26	60	55	56	56	53	46	36	27	
	50	43	36	35	35	34	31	25	20	49	43	43	42	40	34	27	21	59	52	51	50	46	40	31	23	
	20	37	29	26	24	22	18	14	12	45	38	35	33	29	24	18	14	58	50	45	42	39	33	25	18	
			Velocity app. 9 [m/s]								Velocity app. 12 [m/s]								Velocity app. 15 [m/s]							
			Flow 2806 [l/s]								Flow 3741 [l/s]								Flow 4676 [l/s]							
	500	68	66	72	75	72	64	52	40	73	71	76	78	75	66	53	40	78	75	79	81	78	69	54	40	
	200	68	64	66	67	64	56	44	33	75	70	71	71	68	59	47	34	81	76	76	75	72	63	50	36	
	100	68	62	62	61	58	50	39	29	76	70	68	67	63	56	43	31	83	76	73	72	69	61	47	33	
50	69	62	59	57	53	46	36	26	77	69	65	63	60	53	41	29	82	75	70	68	66	58	44	31		
20	68	60	54	52	49	42	32	22	74	66	60	59	56	49	37	25	78	70	64	64	62	54	40	27		





# UltraLink® Controller

# FTCU

## Technical data

### Pressure drop graphs with noise data to the surroundings

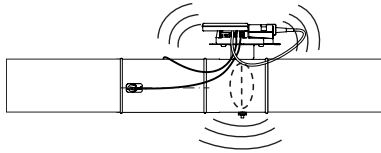

The graphs show A-weighted sound **power** level,  $L_{WA}$  [dB], to the surroundings.

#### Example:

Given:

- Diameter 125 mm
- Flow 50 l/s
- Pressure drop 100 Pa

The graph gives:

- A-weighted sound
- Power level approx. 28 dB

The FTCU unit can easily be insulated and then the sound **pressure** level in the room will be much lower depending on the insulation sound performance on condition that also the connected ducts are attenuated (insulated) to the same extent.

Still lower sound **pressure** level can be achieved with additional constructional sound attenuation measures (false ceiling, high room attenuation).

### Ø100

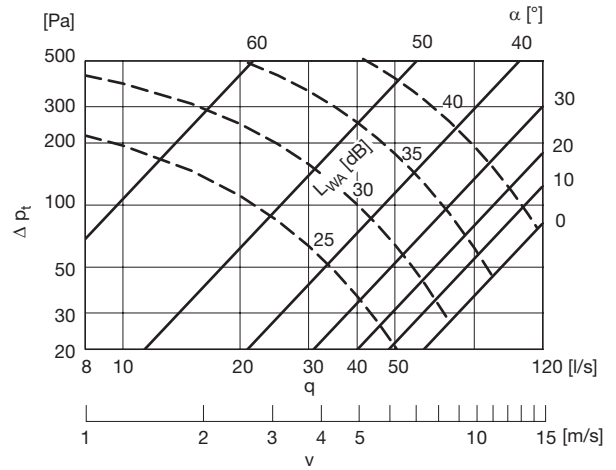

### Ø125

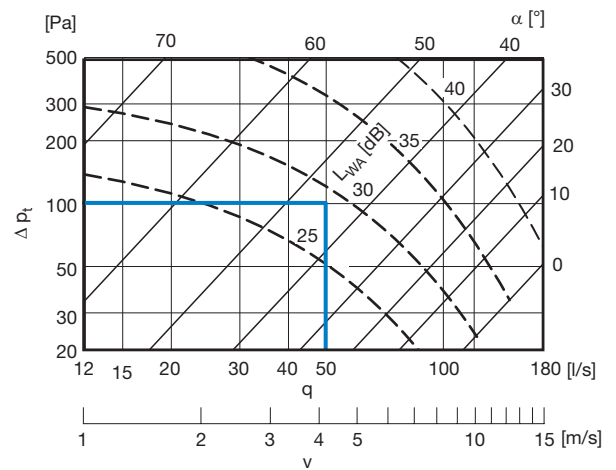

### Ø160

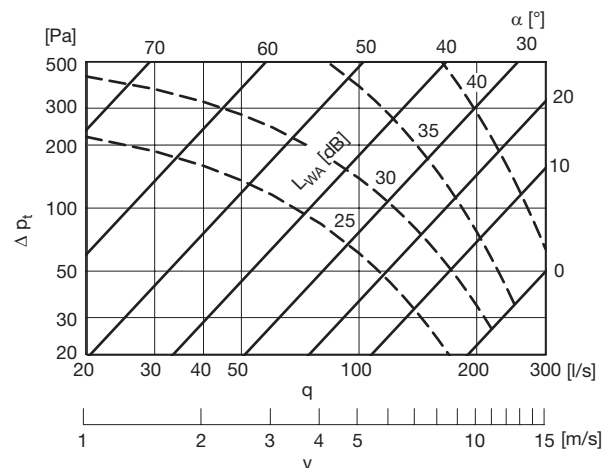

# UltraLink® Controller

# FTCU

## Ø200

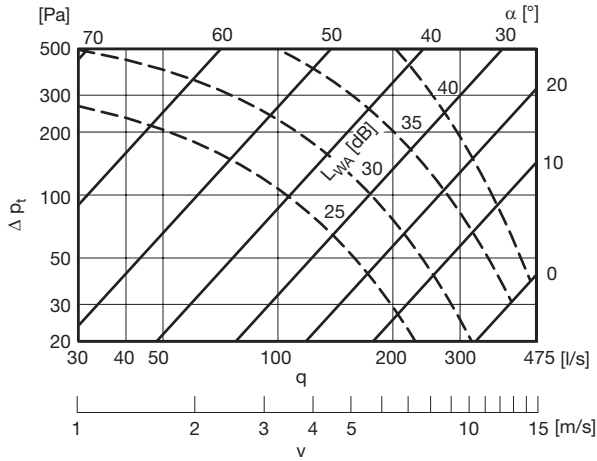

## Ø400

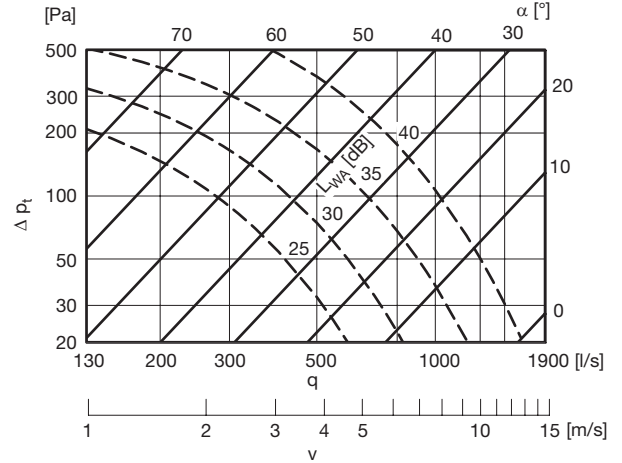

## Ø250

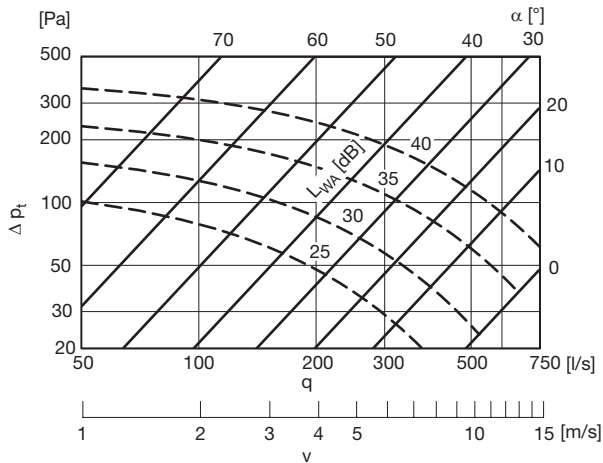

## Ø315

