



Lindab Connect

Waterborne indoor climate solutions

Regula Connect – What do I get?



Regula Connect – What do I get?

Regula Connect Basic

Regula Connect Basic

While ordering a Regula Connect Basic integrated into the product or separate there is included a 2-pin Weidmüller contact for the supply, which is pre-mounted as picture 1 shows.

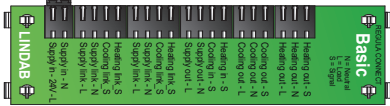

Picture 1. Weidmüller 2-pole-female (670290).

Regula Connect Basic + Actuator cooling

If there is ordered integrated actuator for cooling in combination with the Regula Connect Basic, the actuator will be connected to the connection card via an included 3-pin Weidmüller contact. (picture 2)

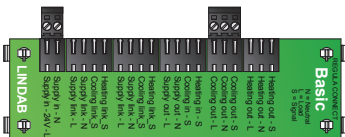

Picture 2. Weidmüller 1 x 2-pole-female (670290) and 1 x 3-pole-female (670291).

Regula Connect Basic + Actuator cooling + Actuator heating

If there is ordered integrated actuator for cooling and heating in combination with the Regula Connect Basic, the actuators will be connected to the connection card via two included 3-pin Weidmüller contacts. (picture 3)

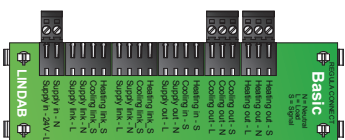

Picture 3. Weidmüller 1 x 2-pole-female (670290) and 2 x 3-pole-female (670291).

NB! If actuators not are ordered integrated, please remember to order the 3-pin Weidmüller contacts separate.

- Weidmüller 3-pole - female (670291).

Regula Connect Multi

Regula Connect Multi

While ordering a Regula Connect Multi integrated into the product or separate there is included a 2-pin Weidmüller contact for the supply, which is pre-mounted as picture 4 shows.

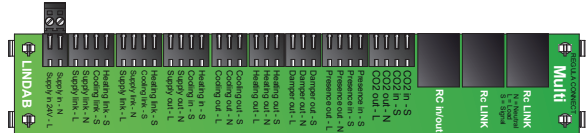

Picture 4. Weidmüller 2-pole-female (670290).

Regula Connect Multi + Actuator cooling

If there is ordered integrated actuator for cooling in combination with the Regula Connect Multi, the actuator will be connected to the connection card via an included 3-pin Weidmüller contact. (picture 5)

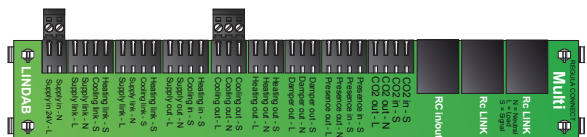

Picture 5. Weidmüller 1 x 2-pole-female (670290) and 1 x 3-pole-female (670291).

Regula Connect Multi + Actuator cooling + Actuator heating

If there is ordered integrated actuator for cooling and heating in combination with the Regula Connect Multi, the actuators will be connected to the connection card via two included 3-pin Weidmüller contacts. (picture 6)

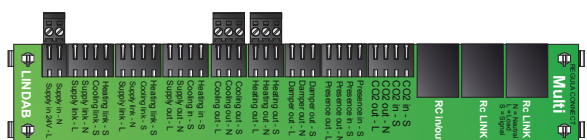

Picture 6. Weidmüller 1 x 2-pole-female (670290) and 2 x 3-pole-female (670291).

NB! If actuators not are ordered integrated or if CO₂ sensor and/or damper should be connected, please remember to order the 3-pin (actuator) or 4-pin (CO₂ and damper) Weidmüller contacts separate.

- Weidmüller 3-pole - female (670291).
- Weidmüller 4-pole - female (670666).

Regula Connect – What do I get?

Regula Connect Pascal

Regula Connect Pascal

When ordering a Regula Connect Pascal card, integrated into the product or separate there is included a 2-pin Weidmüller contact for the supply, which is premounted as picture 7 shows.

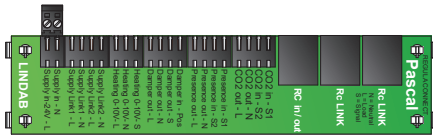

Picture 7. Weidmüller 2-pole-female.

Regula Connect Pascal + Actuator cooling 0-10 V + Vol- flow regulator 2-10 V

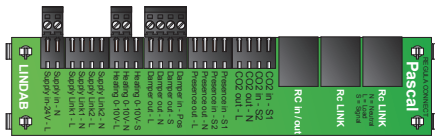

Picture 8. 2 x Weidmüller 2-pole female (One for power supply, always included) and 1 x 3-pole female. See picture 8.B for simplified Wiring scheme configurator shot.

Regula Connect Pascal + Actuator heating 0-10 V + Vol- flow regulator 2-10 V

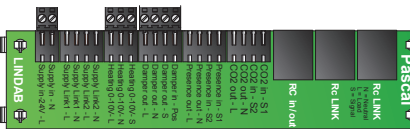

Picture 9. 1 x Weidmüller 2-pole female (for power supply, always included), 1 x 3-pole female+ 1 x 4 pole male. See picture 9.B for simplified Wiring scheme configurator shot.

Weidmüller plugs

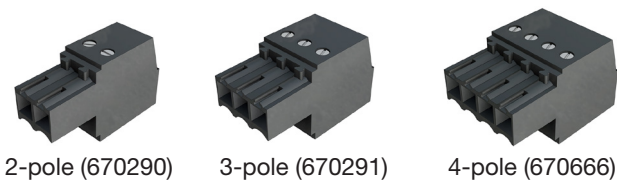

Regula Connect Pascal is in the following examples used with the controller unit Regula Combi and in the 2 scenarios on this page they are cabled together with a T568B cable.

Visit www.lindQST.com and use the “wiring scheme configurator” to design your own system and explore the many connection possibilities, such as CO₂ sensors, presence sensors etc.

Other actuators, and sensors can be connected and will result in the use of other plugs and different cabling. In the Wiring configurator you can always see the correct plugs and cables needed and you will have a complete wiring diagram of your new system.

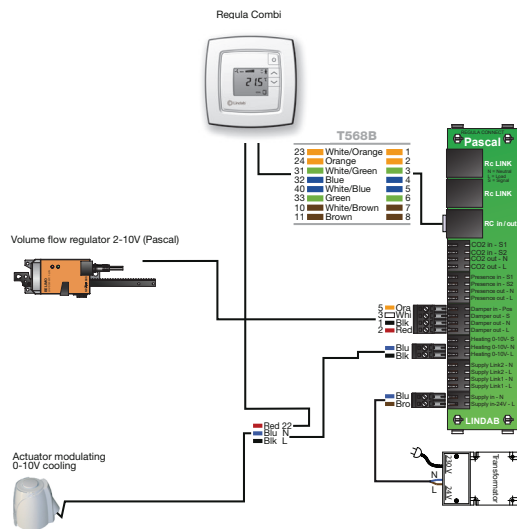

Picture 8.B
NOTE! The Cooling actuator red wire is connected to the Regula Combi plinth 22 and the 2 other wires are connected to the Pascal card via a 2 Weidmüller 2-pole plug.

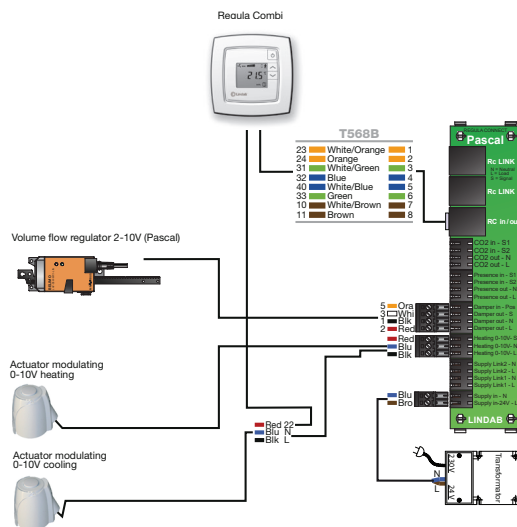

Picture 9.B
NOTE! When a heating actuator added to the system the the 2-pole weidmüller plug is replaced with a 3-pole plug which now is shared by the two actuators. The cooling actuator red wire is still connected to the Regula Combi plinth 22.

Regula Connect – What do I get?

Regula Cables

Cable colors: White – heating link_S
Green – cooling link_S
Brown– Supply link_N
Yellow– Supply link_L
(S- signal; N- neutral; L- load)

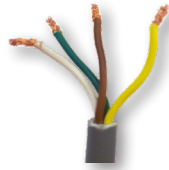

Cables to Regula Connect Basic and Multi

1. Regula Connect cable Weidmüller - 2 m = Cable with 2 pcs Weidmüller black 4-pin.

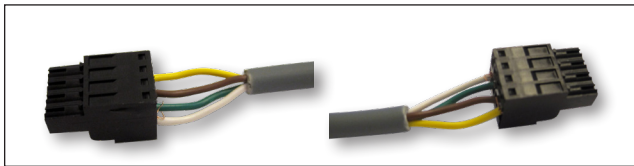

Picture 7. Regula Connect cable Weidmüller - 2m (682511)
- 4m (682512)
- 6m (682513)

RJ-45 cable - 2, 3, 5, 10 m =
Regula Connect Multi com cable

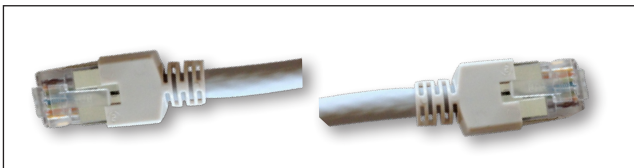

Picture 8. RJ-45 Cable - 2m (681977).

Cables to Regula Combi/Duo

1. Regula Combi Connect cable Weidmüller – 4 m = Cable with 1 pcs Weidmüller black 4-pin and open electrical wires for connection directly to Regula Combi.

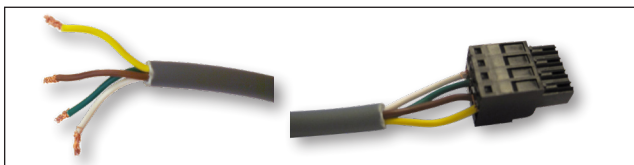

Picture 9. Regula Combi Connect cable Weidmüller - 4 m (682515).

How do I do to only transfer the electrical power?

When connecting connection cards with each other and only the electrical power should be transferred, the green and white wires should be cut off.

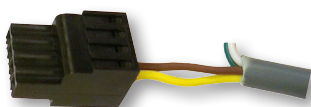

For example (682511)

Regula Connect – What do I get?

Transformer

Transformer F models are delivered with a 2-pin Weidmüller contact.

Transformer T models are not delivered with any wires.

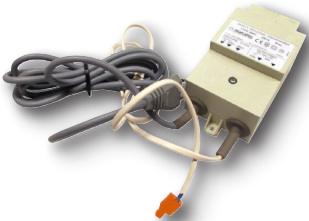

Transformer F



Transformer T

Regula Combi

Connecting Regula Combi to Regula Connect Basic/Multi.

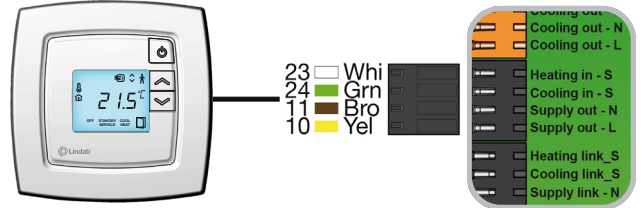

Regula Duo

Connecting Regula Duo to Regula Connect Basic/Multi.

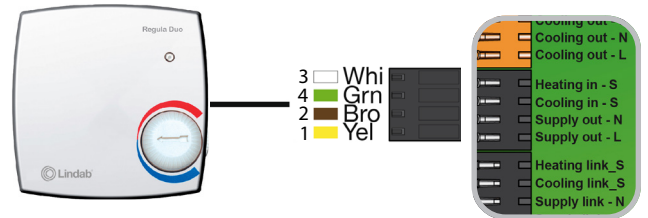

Regula Connect – What do I get?

Order numbers for ordering cables and accessories:

Regula Combi 1,5 RAL 9003	686715
Regula Duo RAL 9003	686845
Regula Connect Basic card	682087
Regula Connect Multi card	682089
Regula Connect Pascal card	649174
Regula Connect cable Weidmüller - 2m	682511
Regula Connect cable Weidmüller - 4m	682512
Regula Connect cable Weidmüller - 6m	682513
Regula Combi Connect cable Weidmüller - 4m	682515
Weidmüller 2-pole black - female	670290
Weidmüller 3-pole black - female	670291
Weidmüller 4-pole black - male	670666
RJ-45 Cable - 2m	681977
RJ-45 Cable - 3m	681978
RJ-45 Cable - 5m	681979
RJ-45 Cable - 10m	681980
Transformer F 35VA	642636
Transformer F 105VA	686025
Transformer T 35VA	642640
Transformer T 60VA	642641
Transformer T 75VA	686014
Transformer T 105VA	686015
Transformer T 150VA	686016



Support

Hjælp

Hjälp

Tuotetuki

Unterstützung

Supporto

Support

UK - Here you can find product updates/mounting instructions and support telephone number/mail.

www.lindab.com

Right to alterations reserved.

DK - Her kan du finde seneste produkt opdateringer/ montagevejledninger samt support tlf. nr/mail.

www.lindab.dk

Ret til ændringer forbeholdes.

SE - Här kan du alltid hitta senaste produktuppdateringarna/montageanvisningarna samt support tel. /e-mail.

www.lindab.se

Rätt till ändringar förbehålles.

FI - Täältä löydät uusimmat tuotetiedot ja asennusohjeet sekä tuotetuen yhteystiedot.

www.lindab.fi

Oikeus muutoksiin pidätetään.

DE - Hier finden Sie aktuelle Produktinformationen/ Montageanleitungen und Telefonnummer/ E-Mail-Adressen der Ansprechpartner.

www.lindab.de

Änderungen vorbehalten.

IT - Qui potete trovare istruzioni di montaggio, informazioni sul prodotto ed un supporto tecnico qualificato
Tel. 011 9952099 - e-mail: lindab@lindab.it

www.lindab.it

Soggetto a modifica senza obbligo di preavviso.

FR - Vous trouverez les fiches produits ou de montage actualisées ainsi que les coordonnées du support téléphonique à l'adresse suivante :

www.lindab.fr

Toutes modifications réservées.

Do you have trouble finding your local contacts please go to:

www.lindab.com

REGULA CONNECT - 2021-09-06

