

Bogen

BSFTR 60°

- 1
- 2
- 3
- 4
- 5
- 6
- 7
- 8
- 9
- 10
- 11
- 12
- 13
- 14
- 15
- 16
- 17
- 18



Beschreibung
Segmentbogen, gefalzt

Dimensionen

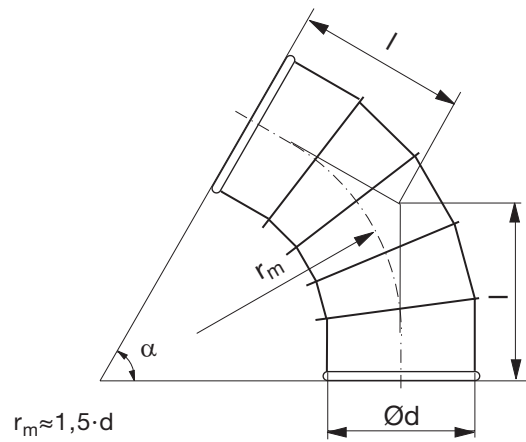

Ød nom	t mm	r_m mm	l mm	m kg
200	0,7	300	260	2,30
224	0,7	336	281	2,70
250	0,7	375	304	3,10
300	0,7	450	341	4,20
315	0,7	472	354	4,60
350	0,7	525	384	5,60
400	0,9	600	427	8,10
450	0,9	675	471	10,1
500	0,9	750	514	12,1

Bestellbeispiel

