

Bend

BUIN 45°



Description

The bend is double-jacketed and insulated with mineral wool, and is supplied with Safe rubber seal in the inner dimension.

Dimensions

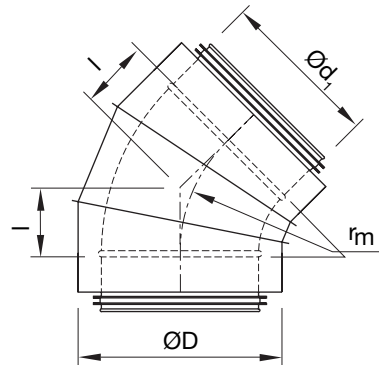

$$r_m = 1 \times \text{Ø}d_1$$

Ød ₁ nom	ØD mm	l mm	m kg
80	112	41	0,45
100	132	41	0,55
125	157	52	0,75
160	192	66	1,25
180	200	76	1,35
200	232	83	1,65
224	260	93	2,15
250	280	103	2,60

Ordering example

