

Bend

BSFTR 90°



Description

Segmented and swaged bend.

Dimensions

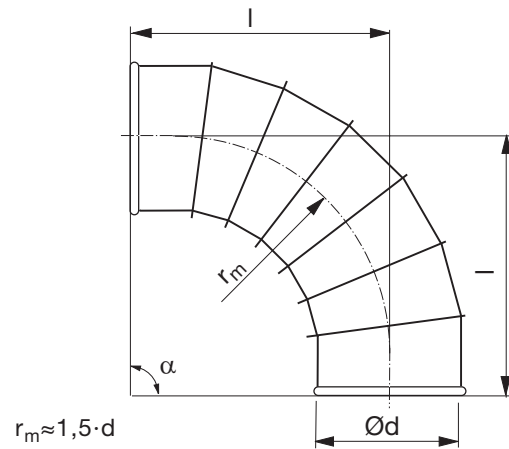

Ød nom	t mm	r _m mm	l mm	m kg
200	0,7	300	387	3,40
224	0,7	336	423	4,20
250	0,7	375	462	4,90
300	0,7	450	531	6,40
315	0,7	472	553	7,10
350	0,7	525	606	9,00
400	0,9	600	681	13,1
450	0,9	675	756	16,2
500	0,9	750	831	19,5
560 *	0,9	840	875	29,3
600 *	0,9	900	935	32,7
630 *	0,9	945	980	37,3
710 *	0,9	1065	1100	47,0
800 *	0,9	1200	1235	54,5
900 *	0,9	1350	1385	74,8

* Supplied with flange FL

Ordering example

